

平头锁眼机(触摸屏 E)  
2016-06



## 前言

欢迎您使用此电脑锁眼机控制系统。

请您仔细阅读本说明书，以确保正确的操作使用电脑锁眼机，请按照本说明书内注明的方式进行操作，否则，如违规操作所造成损失本公司不承担责任。此外，请将本说明书妥善保存在安全地点，以便随时查阅，若发生故障须由本公司指定的技术人员或专业人员进行维修。

## **Forewords**





Thank you for using our Computerized Control System for Buttonhole Machine.

It is appreciated that you do read this manual carefully in order to operate the machine correctly and effectively. If the user operates the machine contrary to regulations herein, thus causes losses to user or third party, we will not take any responsibility. Besides that, you should keep this manual for future use. For any fault or problem of machine, please ask the professionals or the technicians authorized by us for repair service











## 安全注意事项

### 1. 安全操作的标志及含义

本使用说明书及产品所使用的安全标志是为了让您正确安全的使用产品，防止您及其他人受到伤害。标志的图案和含义如下：

 <b>危险</b>	如果忽视此标记而进行错误的操作，会导致人员的重伤或死亡。
 <b>注意</b>	如果忽视此标记而进行错误的操作，会导致人员的受伤和设备的损坏。
	该符号表示“应注意事项”。三角中的图案表示必须要注意的内容。（例如左边的图案表示：“当心受伤”）
	该符号表示“禁止”
	该符号表示“必须”。圆圈中的图案表示必须要做的内容。（例如左边的图案表示“必须接地”）

### 2. 安全注意事项





 <b>危险</b>	
	打开控制箱时，先关闭电源开关并将电源插头从插座上拔下后，等待至少 5 分钟后，再打开控制箱盖。触摸带有高电压的区域会造成人员受伤。
 <b>注意</b>	
<b>使用环境</b>	
	应避免在强电气干扰源（如高频焊机）的附近使用本缝纫机。 强电气干扰源可能会影响缝纫机的正常操作。
	电源电压的波动应该在额定电压的±10%以内的环境下使用。 电压大幅度的波动会影响缝纫机的正常操作，需配备稳压器。
	环境温度应在 0℃~45℃ 的范围内使用。 低温或高温会影响缝纫机的正常操作。
	相对湿度应在 35%~85% 的范围内，并且设备内不会形成结露的环境下使用。干燥、潮湿或结露的环境会影响缝纫机的正确操作。
	压缩空气的供气量应大于缝纫机所要求的总耗气量。压缩空气的供气量不足会导致缝纫机的动作不正常。
	万一发生雷电暴风雨时，关闭电源开关，并将电源插头从插座上拔下。雷电可能会影响缝纫机的正确操作。
<b>安装</b>	
	请让受过培训的技术人员来安装缝纫机。

	安装完成前，请不要连接电源。 如果误按启动开关，缝纫机动作会导致受伤。
	缝纫机头倒下或竖起时，请用双手操作。不要用力压缝纫机。 如缝纫机失去平衡，缝纫机滑落到地上会造成受伤或机器损坏。
	必须接地。 接驳地线不牢固，是造成触电或误动作的原因。
	所有电缆应固定在离活动部件至少 25mm 以外处。另外，不要过度弯曲或用卡钉固定得过紧。 会引起火灾或触电的危险。
	请在机头上安装安全罩壳。
<b>缝纫</b>	
	本缝纫机仅限于接受过安全操作培训的人员使用。
	本缝纫机不能用于除缝纫外的任何用途。
	使用缝纫机时必须戴上保护眼镜。 如果不戴保护眼镜，断针时机针折断部分可能会弹入眼睛造成伤害。
	发生下列情况时，请立即切断电源。否则误按下启动开关时，会导致受伤。 1.机针穿线时    2.更换机针时    3.缝纫机不使用或人离开缝纫机时
	缝纫过程中，不要触摸任何运动部件或将物件靠在运动部件上，因为这会导致人员受伤或缝纫机损坏。
	如果缝纫机操作中发生误动作，或听到异常的噪声或闻到异常的气味，应立即切断电源。然后请与购买商店或受过培训的技术人员联系。
	如果缝纫机出现故障，请与购买商店或受过培训的技术人员联系。
<b>维护和检查</b>	
	只有经过训练的技术人员才能进行缝纫机的维修、保养和检查。
	与电气有关的维修、保养和检查请及时与电控厂家的专业人员进行联系。
	发生下列情况时，请关闭电源并拔下电源插头。否则误按启动开关时，会导致受伤。 1. 检查、调整和维修    2. 更换弯针、切刀等易损零部件
	在检查、调整和修理任何使用气动设备之前，请先断开气源，并等压力表指针下降到“0”为止。
	在必须接上电源开关和气源开关进行调整时，务必十分小心遵守所有的安全注意事项。
	未经授权而对缝纫机进行改装而引起的缝纫机损坏不在保修范围内。











## Safety Matters for Attention

















### 1.Signs & Definitions of Safety Marks

This User's Manual and the Safety Marks printed on the products are for you to use this product correctly so as to be away from personal injury. The signs and definitions of Marks are shown at below:

 Danger	Danger: The incorrect operation due to negligence will cause the serious personal injury or even death.
 Caution	Caution: The incorrect operation due to negligence will cause the personal injury and the damage to mechanism
	This kind of marks is "Matters for Attention", and the figure inside the triangle is the content for attention. (Exp. The left figure is "Watch Your Hand!")
	This kind of mark is "Forbidden".
	This kind of mark means "Must". The figure in the circle is the contents that have to be done. (Exp. The left figure is "Ground!")

### 2.Safety Matters for Attention

 <b>Danger</b>	
	For opening the control box, please turn off the power and take away the plug from socket firstly, and then wait for at least 5 minutes before opening the control box. Touching the part with high voltage will cause the personal injury.
 <b>Caution</b>	
<b>Usage Environment</b>	
	Try not to use this sewing machine near the sources of strong electronic disturbance like (high-frequency welding machine). The source of strong electronic disturbance will affect the normal operation of the sewing machine.
	The voltage fluctuation shall be within $\pm 10\%$ of the rated voltage. The large fluctuation of voltage will affect the normal operations of sewing machine, and the regulator will be needed in that circumstance
	Working temperature: $0^{\circ}\text{C} \sim 45^{\circ}\text{C}$ . The operation of the sewing machine will be affected by environment with temperature beyond the above range.
	Relative Humidity: 35% ~ 85 % ( No dew inside the machine), or the operation of sewing machine will be affected.
	The supply of the compressed gas should be over the consumption of the sewing machine. The insufficient supply will be cause the abnormal operation of the machine.
	In case of thunder, lightning or storm, please turn off the power and pull plug out the socket. Because these will have the influence on the operation of sewing machine
<b>Installation</b>	
	Please ask the trained technicians to install the sewing machine.
	Don't connect machine to power supply until the installation is finished. Otherwise the action of sewing machine may cause personal injury once the start switch is pressed by mistake.

	When you tilt or erect the head of sewing machine, please use both of your hands in that operation. And never press the sewing machine with strength. If the sewing machine loses its balance, it will fall into floor thus causes the personal injury or mechanical damage.
	Grounding is a must. If the grounding cable is not fixed, it may cause the electric-shock and mis-operation of machine
	The entire cables shall be fixed with a distance at 25mm away from the moving component at least. By the way, don't excessively bend or tightly fixed the cable with nails or clamps, or it may cause the fire or electric shock.
	Please attach the safety cover at the head.
<b>Sewing</b>	
	This sewing machine can only be used by the trained staff.
	This sewing machine has no other usages but the sewing.
	When operating the sewing machine, please remember to put on the glasses. Otherwise, the broken needle will cause the personal injury.
	At following circumstances, please cut off the power at once so as to avoid the personal injury caused by the mis-operation of start switch: 1. Threading; 2. Replacement of needles; 3. The sewing machine is left unused or beyond supervision
	At working, don't touch or lean anything on the moving components, because both of the above behaviors will cause the personal injury or the damage to the sewing machine
	During working, if the mis-operation happens or the abnormal noise or smell is found at the sewing machine, user shall cut off the power at once, and then contact the trained technicians or the supplier of that machine for solution.
	For any trouble, please contact the trained technicians or the supplier of that machine.
<b>Maintenance &amp; Inspection</b>	
	Only can the trained technicians perform the repair, maintenance and inspection of this sewing machine.
	For the repair, maintenance and inspection of the electrical component, please contact the professionals at the manufacturer of control system in time.
	At following circumstances, please cut off the power and pull off the plug so as to avoid the personal injury caused by the mis-operation of start switch: 1.Repair, adjustment and inspection ; 2. Replacement of the consumptive devices, like needle, knife and so on.
	Before checking, adjusting and repair any air-driven equipment, user needs cut off the source of gas and wait for the pressure indicator drop to "0".
	If you have to adjust the machine when the power is on, you can't be too careful at following the entire Safety Matters for Attention
	If the sewing machine damages due to the unauthorized modification, our company will not be responsible for it.





# 目录

<b>1 概要说明</b> .....	1
1.1 概述 .....	1
1.2 功能和指标参数 .....	1
1.3 标准化 .....	2
1.4 安全使用注意事项 .....	2
1.5 使用上的预防措施 .....	3
1.6 操作方式 .....	5
1.7 基本缝制形状一览 .....	5
<b>2 缝制前准备</b> .....	7
2.1 机针的安装方法 .....	7
2.2 上线的穿线方法 .....	7
2.3 梭壳的安装方法 .....	8
2.4 梭壳的穿线方法 .....	9
2.5 底线张力的调整 .....	9
2.6 切刀的安装方法 .....	10
2.7 机油加注方法 .....	12
<b>3 操作说明</b> .....	13
3.1 各部位的名称和说明 .....	13
3.2 通用按键 .....	14
3.3 基本操作 .....	14
3.4 普通花样操作 .....	15
3.5 连续缝花样操作 .....	17
3.6 循环缝花样操作 .....	19
<b>4 普通花样缝制</b> .....	22
4.1 界面功能键 .....	22
4.2 花样登记 .....	25
4.3 花样复制 .....	27
4.4 花样命名 .....	28
4.5 穿线 .....	28
4.6 绕线 .....	29
4.7 选择压脚类型 .....	30
4.8 花样选择 .....	31
4.9 缝制形状选择 .....	32
4.10 缝制数据设置 .....	34
4.11 直接选择花样 .....	42
4.12 试缝操作 .....	42
4.13 上线张力设置 .....	44
4.14 计数器操作 .....	45
4.15 急停 .....	46
4.12 VDT 花样操作 .....	47
4.12.1 VDT 花样显示与操作 .....	47
4.12.2 VDT 花样缝制数据表 .....	48

5 连续缝花样缝制 .....	50
5.1 功能说明 .....	50
5.2 连续缝编辑 .....	51
5.2.1 连续缝花样选择 .....	51
5.2.2 连续缝花样编辑 .....	51
5.2.3 连续缝花样登记 .....	53
5.2.4 连续缝花样复制 .....	55
5.2.5 连续缝花样的删除 .....	55
5.3 连续缝制界面 .....	59
5.3.1 功能说明 .....	59
5.3.2 连续缝试缝 .....	60
6 循环缝花样缝制 .....	64
6.1 功能说明 .....	64
6.2 循环缝编辑 .....	64
6.2.1 花样登记 .....	64
6.2.2 花样复制 .....	65
6.2.3 循环缝花样选择 .....	66
6.2.4 循环缝花样编辑 .....	67
6.2.5 变更缝制衣物 .....	68
6.3 循环缝制界面 .....	69
6.3.1 功能说明 .....	69
6.3.2 循环缝试缝 .....	71
7 模式设置 .....	74
7.1 功能说明 .....	75
7.2 一级参数设置 .....	76
7.3 二级参数设置 .....	80
7.4 计数器设置 .....	83
7.4.1 功能介绍 .....	84
7.5 用户管理项设置 .....	85
7.6 缝制数据编辑 .....	86
7.7 变换缝制类型 .....	87
7.8 登记花样到直接按键上 .....	87
7.9 检测模式 .....	88
7.10 亮度调节 .....	93
7.11 锁键盘操作 .....	94
7.12 格式化操作 .....	95
7.13 参数备份还原 .....	97
8 通讯功能 .....	98
8.1 关于可以处理的数据 .....	98
8.2 功能操作 .....	98
8.3 花样传输 .....	99
8.4 参数传输 .....	101
8.5 软件升级 .....	102
9 信息功能 .....	104

9.1 查看维修保养信息 .....	104
9.2 维修保养时间设置 .....	106
9.3 警告的解除方法 .....	107
9.4 生产管理信息 .....	108
9.4.1 从信息界面显示 .....	108
9.4.2 从缝制界面显示 .....	109
9.4.3 生产管理信息设定 .....	110
9.5 显示穿线图 .....	113
9.6 报警记录 .....	114
9.7 运转记录 .....	115
9.8 分期密码设置 .....	116
10 附录 1 .....	124
10.1 报警信息一览表 .....	124
10.2 信息提示一览表 .....	127
10.3 常见故障处理 .....	129
10.4 形状初始值数据一览表 .....	132
11 附录 2 .....	137
11.1 电控箱安装尺寸 .....	137
11.2 控制箱外部连接线缆 .....	139
11.3 操作箱安装尺寸 .....	140
11.4 系统框图 .....	141

**Contents**

1 General Information.....145

    1. 1 General.....145

    1. 2 Function and Specification .....145

    1. 3 Standardization .....146

    1. 4 Matters for Safe Using.....146

    1. 5 The Preventions on Instruction .....148

    1. 6 Operation Method.....149

    1. 7 Sewing List .....150

2 Preparation before Sewing .....151

    2. 1 Installation of Needle.....151

    2. 2 Threading (Needle Thread).....151

    2. 3 Installation of Bobbin .....152

    2. 4 Threading at Bobbin .....153

    2. 5 Adjustment of Bobbin Thread Tension.....153

    2. 6 Installation of Knife.....154

    2. 7 Method for Adding Oil .....156

3 Operating Instruction .....157

    3. 1 Name and Description of Each Part.....157

    3. 2 Common Buttons .....158

    3. 3 Basic Operation .....158

    3. 4 Operation of Normal Pattern.....159

    3. 5 Operation of Continuous Sewing.....161

    3. 6 Operation of Cyclic Sewing.....163

4 Normal Pattern Sewing.....166

    4. 1 Function Keys.....166

    4. 2 Pattern Registration .....169

    4. 3 Pattern Copy .....171

    4. 4 Pattern Naming .....172

    4. 5 Threading.....172

    4. 6 Winding .....173

    4. 7 Select the Type of Presser.....174

    4. 8 Pattern Selection .....175

    4. 9 Sewing Shape Selection.....176

    4. 10 Sewing Data Setting .....178

    4.11 Direct Selection of Pattern .....186

    4.12 Trial Sewing.....187

    4.13 Set Needle Thread Tension .....188

    4. 14 Operation of Counter .....189

    4. 15 Emergency Stop .....190

    4. 12 VDT Pattern Operation.....191

        4. 12. 1 Display and Operation of VDT Pattern.....191

        4. 12. 2 Sewing Data of VDT Pattern .....192

5 Continuous Sewing.....194

5. 1 Function List.....	194
5. 2 Edition of Continuous Sewing.....	195
5. 2. 1 Selection of Continuous Sewing Pattern.....	195
5. 2. 2 Edition of Continuous Sewing Pattern.....	195
5. 2. 3 Continuous Sewing Pattern Registration .....	198
5. 2. 4 Continuous Sewing Pattern Copy .....	199
5. 2. 5 Deletion of Continuous Sewing Pattern.....	200
5. 3 Continuous Sewing Interface.....	201
5. 3. 1 Function List.....	201
5. 3. 2 Trial Sewing for Continuous Sewing.....	203
6 Cyclic Sewing.....	204
6. 1 Function List.....	206
6. 2 Edition of Cyclic Sewing.....	206
6. 2. 1 Pattern Registration.....	206
6. 2. 2 Pattern Copy .....	207
6. 2. 3 Selection of Cyclic Sewing Pattern.....	208
6. 2. 4 Edition of Cyclic Sewing Pattern.....	209
6. 2. 5 Change Fabric .....	210
6. 3 Cyclic Sewing Interface.....	211
6. 3. 1 Function List.....	211
6. 3. 2 Trial Sewing at Cyclic Sewing.....	213
7 Mode Setting.....	216
7. 1 Function List.....	217
7. 2 Level 1 Parameter Setting.....	218
7. 3 Level 2 Parameters Setting .....	223
7. 4 Counter Setting .....	226
7. 4. 1 Functions.....	227
7. 5 Settings on User Management .....	228
7. 6 Edition of Sewing Data.....	229
7. 7 Change Sewing Mode.....	230
7. 8 Register Pattern to Direct Button.....	230
7. 9 Test Mode .....	232
7. 10 Brightness Adjustment.....	237
7. 11 Operation of Keyboard Lock .....	237
7. 12 Initialization.....	239
7. 13 Parameter Back-up & Restoration .....	241
8 Communication .....	242
8. 1 About the Available Data.....	242
8. 2 Operations.....	242
8. 3 Pattern Transfer.....	243
8. 4 Parameter Transfer.....	246
8. 5 Software Update .....	247
9 Information .....	249
9. 1 Check the Maintenance Information.....	249

9. 2 Set the Maintenance Time.....	250
9. 3 Method to Release the Warning.....	252
9. 4 Information of Production Control .....	252
9. 4. 1 Via Information Interface.....	252
9. 4. 2 Via Sewing Interface.....	254
9. 4. 3 Setting of Production Control Information .....	254
9. 5 Threading Figure .....	258
9. 6 Warning Record.....	259
9. 7 Running Record.....	260
9. 8 Setting of Periodical Password .....	261
10 Appendix 1.....	268
10. 1 Warning List .....	268
10. 2 Hint List.....	269
10. 3 Common Problems and Solutions.....	272
10. 4 Default Values of Sewing Shapes .....	275
11 Appendix 2.....	283
11. 1 Installation Size of Control Box .....	283
11.2 External Cable Connection of Control Box .....	285
11. 3 Installation Size of Operation Panel .....	286
11. 4 System Diagram.....	287

# 1 概要说明

## 1.1 概述

本工业缝纫机电脑控制系统，主轴电机采用具有世界先进水平的交流伺服控制技术驱动，具有力矩大、效率高、车速稳定和噪音低等特点。操作面板设计多样化可满足不同客户的配套要求；系统采用德国式结构设计，安装和维修方便快捷，系统控制软件可通过远程通讯升级，方便用户不断提高产品性能。

## 1.2 功能和指标参数

本系列数控交流伺服系统的功能及参数详见表 1。

表 1: 功能及参数对照表

序号	项 目	机 型	SC500/MASC500
1	宽幅		5mm (分解能: 0.05mm)
2	切刀尺寸 (切刀长度)		6.4~31.8mm (1/4"~1 1/4")
3	缝制长度 (最大)		41mm (选购配件最大可缝制 120mm)
4	缝制速度		标准 3600rpm 最高 4200rpm
5	速度控制方式		控制面板输入
6	使用机针		DP×5 # 11J ~ # 14J
7	针杆行程		34.6mm
8	挑线杆		链式挑线杆
9	旋梭		DP 型 全自动旋转供油旋梭
10	压脚上升量		14mm (可任意设定) 最大 17mm (逆转抬机针能时)
11	抬压脚驱动方式		脉冲马达式 (1 个踏板 · 2 个踏板)
12	绕线功能		机头内置式 (仅在机器驱动中可绕线)
13	送布驱动方式		脉冲马达式
14	摆针驱动方式		脉冲马达式
15	切刀驱动方式		双向电磁铁驱动
16	面线张力机能		电磁铁张力方式 通过控制面板操作可对各部位进行数据设定 (平行部、套件部张力)
17	缝迹形状		角型、放射型、圆型 (控制面板选择) 等 30 种
18	记忆花样数		500 个花样
19	数据记忆媒体		U 盘
20	1/2 重切换		每个花样都可设定
21	马达		小型 AC 伺服马达 400W 直接驱动方式
22	外形尺寸		机床宽度 200mm、高度 360mm、长度 570mm



23	机头重量	70Kg
24	额定功率	600W
25	使用温度范围	0℃~45℃
26	使用湿度范围	35%~85%
27	电源电压	AC 220V ± 10%; 50/60Hz

压脚规格:

	压脚规格 1	压脚规格 2	压脚规格 3	压脚规格 5
宽度	4mm	5mm	5mm	3-6mm(任意设定)
缝制长度(最大)	25mm	35mm	41mm	10-120mm(任意设定)

机种规格区分 S: 标准 K: 针织规格

※ 产品执行标准: QCYXDK0004—2016 《工业缝纫机计算机控制系统》。

## 1.3 标准化

功能按键采用业界公认的图形标识, 图形是国际化语言, 各国用户都可以识别。

## 1.4 安全使用注意事项

### ● 安装

- 控制箱
  - ◆ 请遵照说明正确装好
- 附件
  - ◆ 如要安装其它附件时, 请先关掉电源并拔掉电源插头。
- 电源线
  - ◆ 请不要用重力去压住电源线或过度的扭曲电源线。
  - ◆ 请不要将电源线靠近转动的部位, 最少要离开 25mm 以上。
  - ◆ 控制箱要接入电源前, 请必再查看要接入的电源电压是否与控制箱上标示的电压相同及确定位置后, 才可供应电源。如有接用电源变压装置的话, 同样的要检查一下后才可供应电源。这时缝纫机上的按钮式电源开关一定要放在 [OFF]。
- 接地
  - ◆ 为防止噪声干扰及漏电而发生电击事件, 电源线上的接地线定要确实做好接地。
- 附属装置
  - ◆ 如要接用电气方面的附属装置的话, 请遵照指示的位置接好。
- 拆卸
  - ◆ 要卸下控制箱时, 必须要先关掉电源并拔掉电源插头。
  - ◆ 在拔离电源插头时不可只拉电源线, 必须用手拿住电源插头拔出。
  - ◆ 控制箱里面有危险的高压电, 所以要打开控制箱盖的话, 需要先关掉电源后等候 5 分钟以上才可打开控制箱盖。

### ● 保养、检查和修理

- 修理和保养的作业，要请经过训练的技术人员执行。
- 更换机针和梭子时，请务必关电。
- 请使用正厂的零件。

### ● 其它的安全对策

- 缝纫机运转中请不要去触摸会转动和会移动的部位 (特别是机针和皮带附件)等, 并注意头发不要靠近它们, 以免发生危险。
- 控制装置不可摔落地, 更不可在空隙间塞入其它物品。
- 请不要在拆掉各护盖的情形下运作。
- 如本控制装置有损伤或无法正常运作时, 必要请有经验的技术人员调整, 或检查修理, 在故障还没排除前请不要再去运转它。
- 敬请各客户们不要自行改造或变更本控制装置。

### ● 废弃处理

- 请以一般产业废弃物处理。

### ● 警告示意和危险示意

- 错误的行为可能会发生危险, 其程度如后述的标示区别说明。

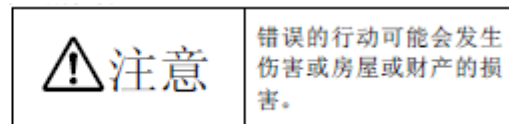
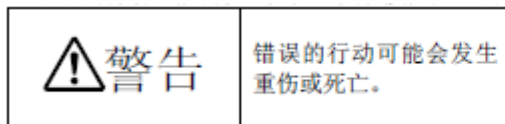

- 标示符号的表示如下说明。

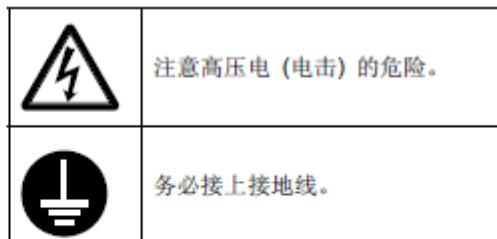

## 1.5 使用上的预防措施

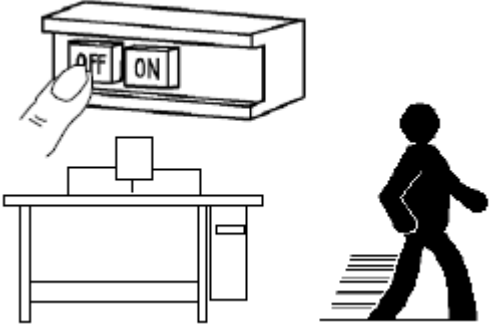
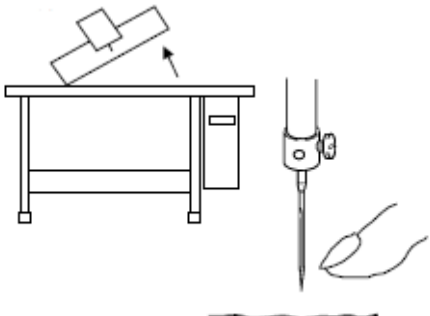
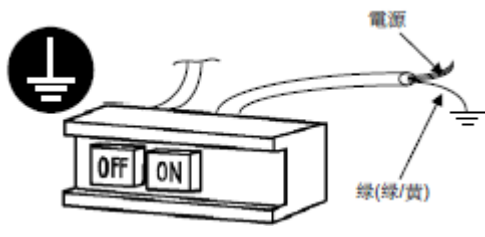
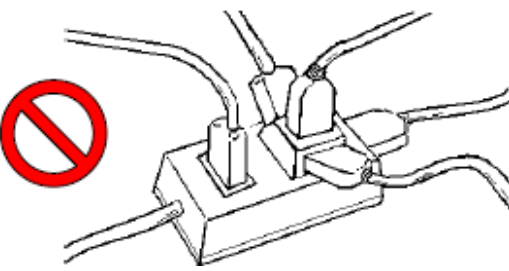
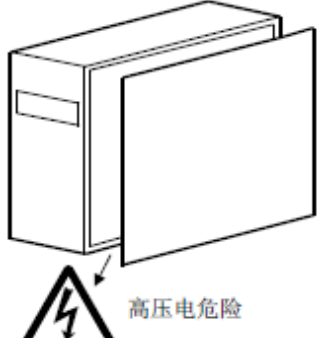
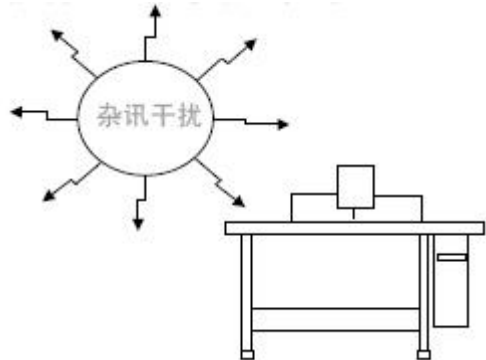
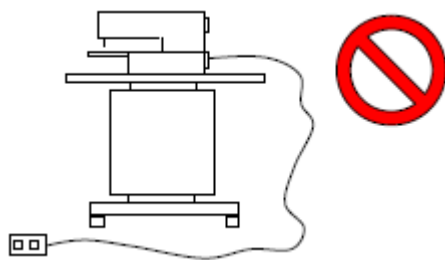

1、要离开工作岗位时，请务必关掉电源。
---------------------

	
<p>3、如要横倒头部或更换机针或穿面线时，请务必关掉电源。</p> 	<p>4、接地线要做好接地。</p> 
<p>5、不要用家庭用多插孔式延长线。</p> 	<p>6、控制箱内部存有危险的高压电，所以关掉电源后等候 5 分钟才可打开控制箱盖。</p> 
<p>8、请远离会产生高周波噪声干扰的机器。</p> 	<p>9、如利用外接信号插座接应用附属装置时，其连接线长度请尽量越短越好，长线可能会导致误动作，连接线请用隔离线缆。</p> 
<p>10、如保险丝烧断时，请先把原因排除后再换相同容量的保险丝。</p>	

## 1.6 操作方式

操作面板采用了业界先进的触摸操作技术，友好的界面以及便捷的操控都给用户的日常使用带来革新性的变化。用户可以使用手指或者其他物体点触屏幕，完成相应的操作。

功能键包括准备键，信息键，模式键以及通信键等。具体操作方法后面章节的说明。

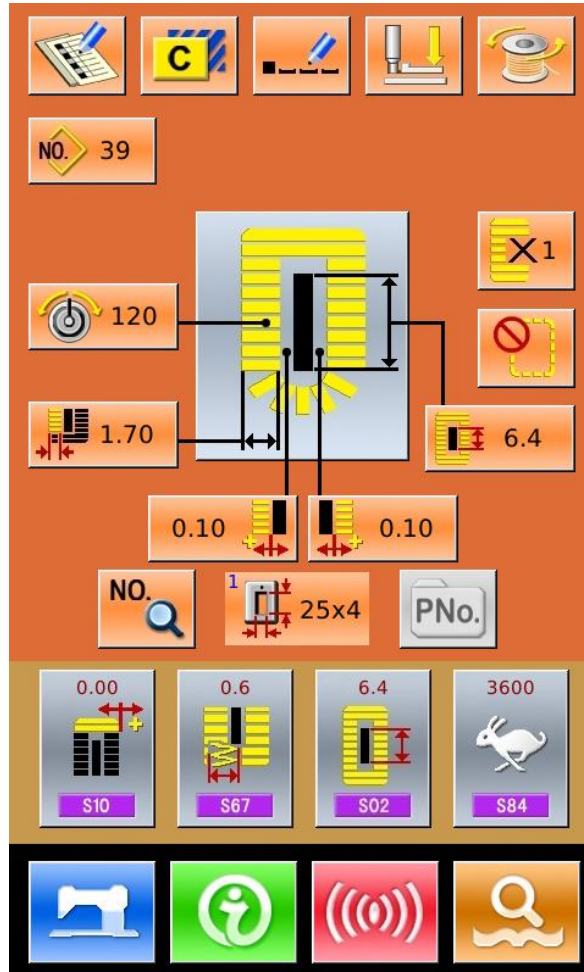

























**警告**

用户在使用过程中应该注意避免使用尖锐的物体触碰屏幕，以免对触摸屏造成永久性损伤。

## 1.7 基本缝制形状一览

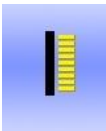
01 方形	02 圆形	03 放射方形	04 放射形	05 放射直线固定型
				

06 放射锥形固定形 	07 圆眼方形 	08 圆眼放射形 	09 圆眼直线加固形 	10 圆眼锥形加固形 
11 半圆形 	12 圆方形 	13 半圆方形 	14 半圆直线加固形 	15 半圆锥形加固形 
16 圆眼半圆形 	17 圆眼圆形 	18 方放射形 	19 方半圆形 	20 方圆形 
21 方直线加固形 	22 方锥形加固形 	23 放射半圆形 	24 放射圆形 	25 半圆放射形 
26 半圆圆形 	27 加固缝 	28 加固右切断 	29 加固左切断 	30 加固中央切断 

## 2 缝制前准备

### 2.1 机针的安装方法



警告

为防止突然地起动造成人身事故，请关掉电源，确认马达完全停止后在进行操作。

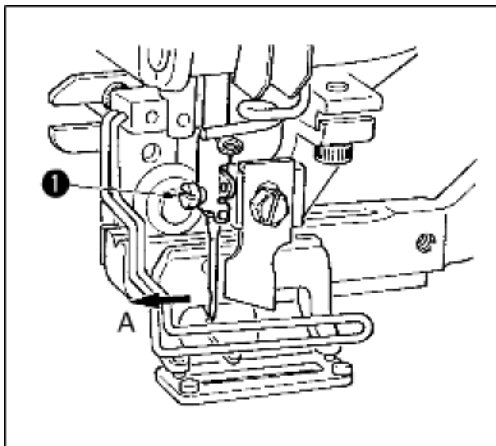

- 1) 转动飞轮，把机针上升到最高位置。
- 2) 从缝纫机正面看，把机针凹部横向转到前侧 A 向
- 3) 然后把机针插进针杆孔的深处
- 4) 旋紧机针固定螺丝①

※ 机针选用 DP×5 # 11J ~ # 14J

**安装机针时，请一定关掉电源**

### 2.2 上线的穿线方法



警告

为防止突然地起动造成人身事故，请关掉电源，确认马达完全停止后在进行操作。

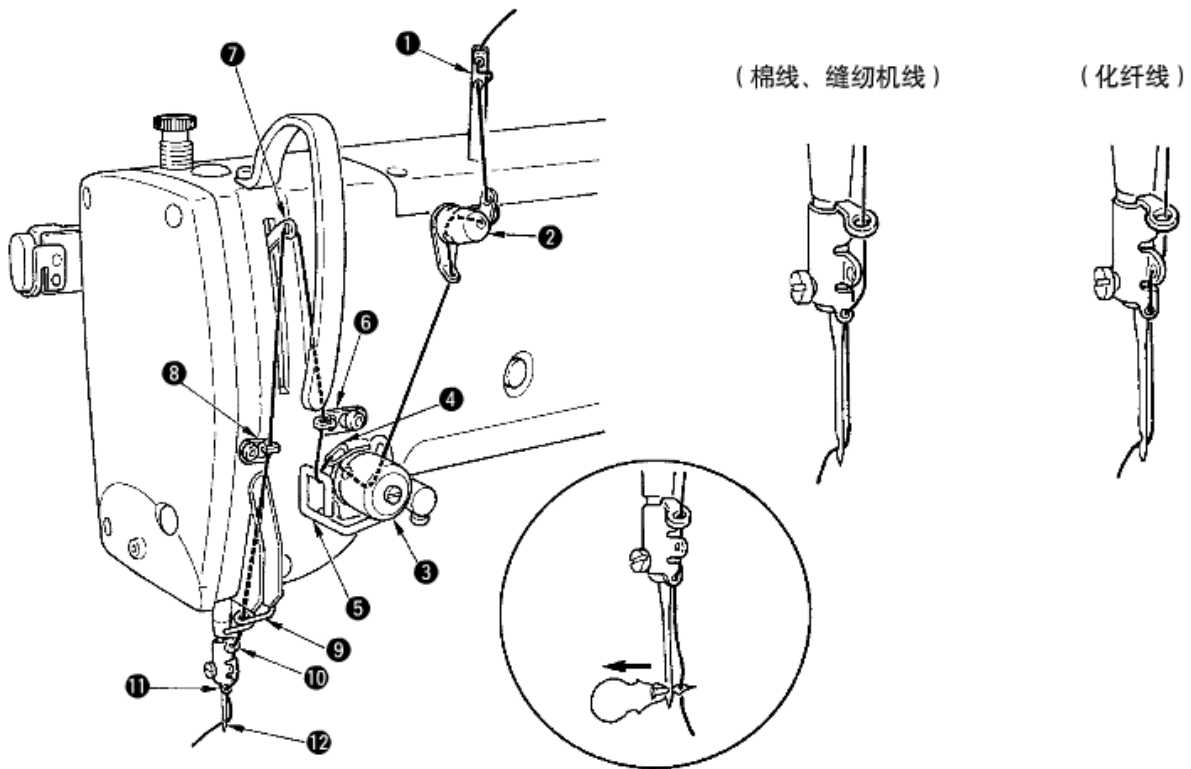

按上图所示，从 1~12 顺序进行即可  
 上线时，使用穿线器可帮助方便、快捷的上线。

### 2.3 梭壳的安装方法

 <p><b>警告</b></p>	<p>为防止突然地起动造成人身事故，请关掉电源，确认马达完全停止后在进行操作。</p>
--	---

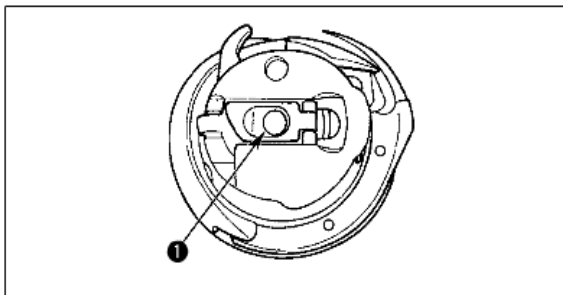

- ① 拔起梭壳抓手
- ② 插入中旋梭轴①，关闭抓手。梭壳被按到一定位置时会听到咔嚓的声音。
- ※ 如果梭壳没有在规定的位置，缝纫后梭芯会飞出来，上线绕到梭轴上
- ※ 标准旋梭和干式旋梭的形状不一样，不能通用

## 2.4 梭壳的穿线方法

 <b>警告</b>	<p>为防止突然地起动造成人身事故，请关掉电源，确认马达完全停止后在进行操作。</p>
---	---

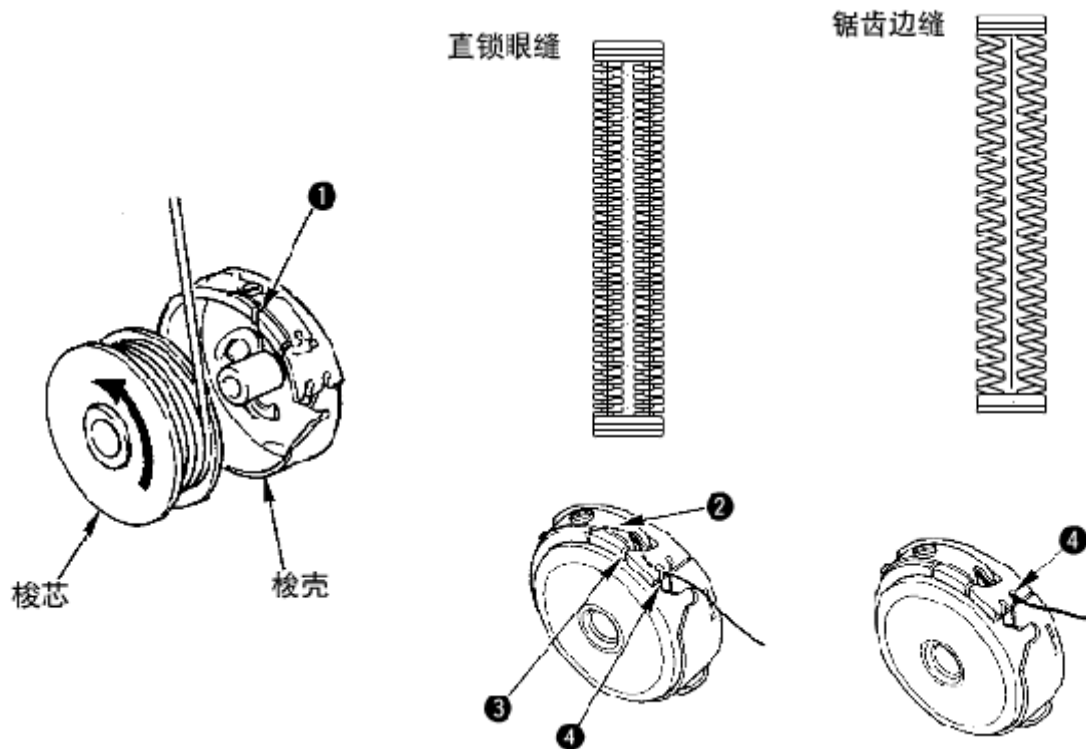

- 1) 按箭头所示方向把梭芯插进梭壳；
- 2) 把机线穿过穿线口①，然后再从张力弹簧②的下面传过去，再穿过穿线口③，从④中把线拉出

※ 注意直锁眼缝和锯齿边缝时，④的穿线方法不同

## 2.5 底线张力的调整

 <b>警告</b>	<p>为防止突然地起动造成人身事故，请关掉电源，确认马达完全停止后在进行操作。</p>
---	---



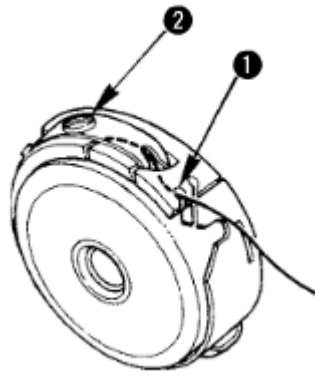

当梭壳穿线口①在上方位置时，把底线向上拉出，按照下面的方法调整张力

直锁眼缝	0.05~0.15N	手拿从梭壳出来的线头，轻轻上下摆动时，梭壳就稍稍下降
锯齿边缝	0.15~0.3N	手拿从梭壳出来的线头，用稍强的力量摆动时，梭壳才下降

把线张力螺丝②向右转动，底线张力变强，向左转动，底线张力变弱

※ 使用化纤机线时，张力稍稍减弱，棉线时稍稍加强

※ 调整底线张力后，请确认缝制参数中的上线张力的设定

## 2.6 切刀的安装方法

 <p><b>警告</b></p>	<p>为防止突然地起动造成人身事故，请关掉电源，确认马达完全停止后在进行操作。</p>
--	---

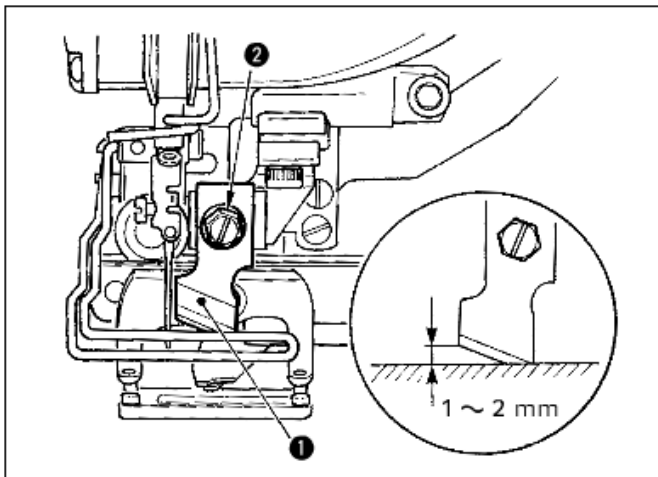

- 1) 卸下切刀固定螺丝②，切刀①和垫片就可以卸下来了
- 2) 用手按下切刀后，如图所示把切刀和针板上面的距离调整到 1~2mm，然后套上垫片，并拧紧固定螺丝。

如果切布刀的尺寸用英制表示时，可以参考下面的转换表，来确定切布刀的长度。

**英寸到公制转换表**

切刀尺寸（英寸）	切刀尺寸（公制）mm
1/4	6.40
3/8	9.50
7/16	11.10
1/2	12.70
9/16	14.30
5/8	15.90
11/16	17.50
3/4	19.10
13/16	20.60
7/8	22.20
1	25.40
1 1/8	28.60
1 1/4	31.80
1 3/8	34.90
1 1/2	38.10

## 2.7 机油加注方法



**警告**

为防止突然地起动造成人身事故，请关掉电源，确认马达完全停止后在进行操作。

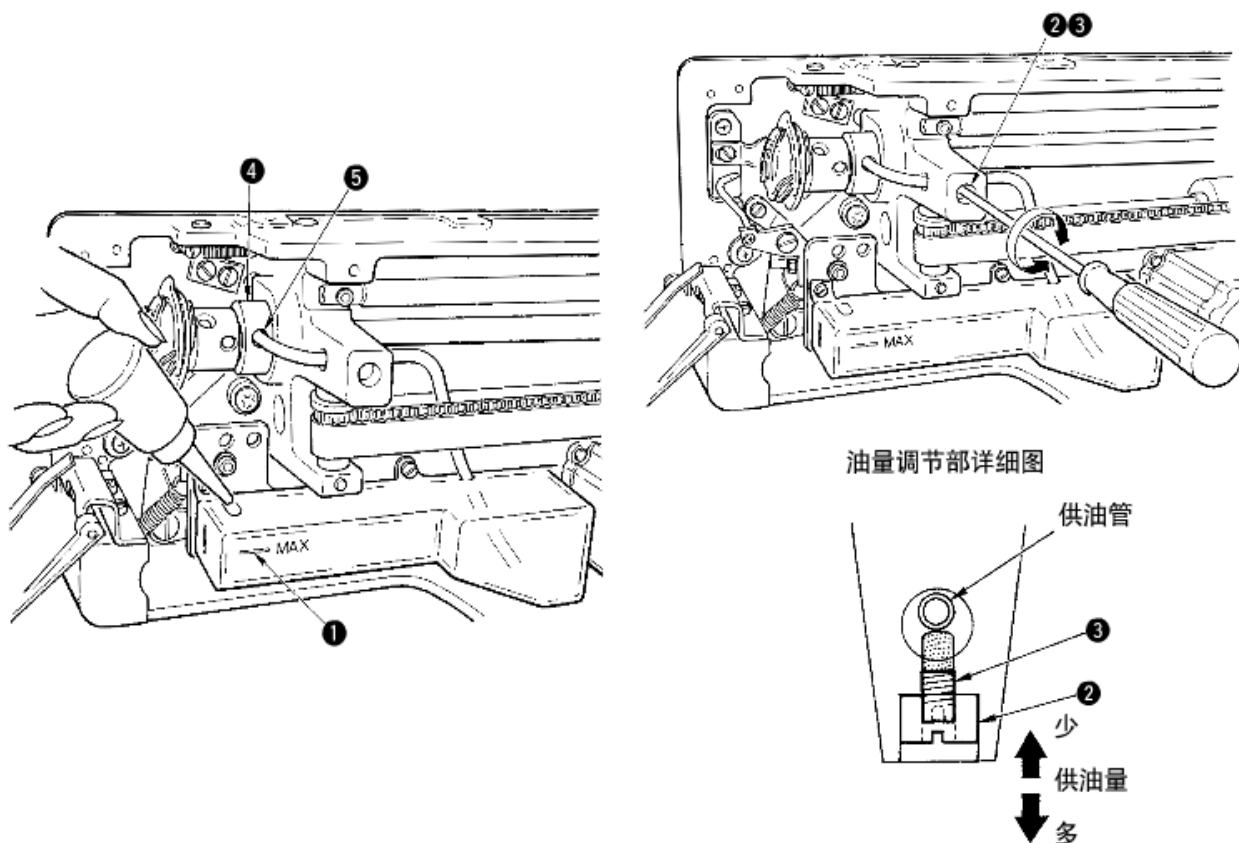

### 1) 向加油罐中加油

- 把机油加满到①MAX 标记的位置

### 2) 旋梭油量调整

- 拧松油量调节固定螺丝②，然后用油量调节螺丝③进行调整
- 调节旋梭油量时，拧紧油量调节螺丝③，则油量减少
- 油量调节后，请用固定螺丝②进行固定
- 新装缝纫机或较长时间没有用过的缝纫机，使用前请取下梭壳，在梭边壳加 2~3 滴机油，另外向下轴前金属部件④的加油孔⑤加几滴机油，把油浸润到里面的毛毡里。

## 3 操作说明

### 3.1 各部位的名称和说明

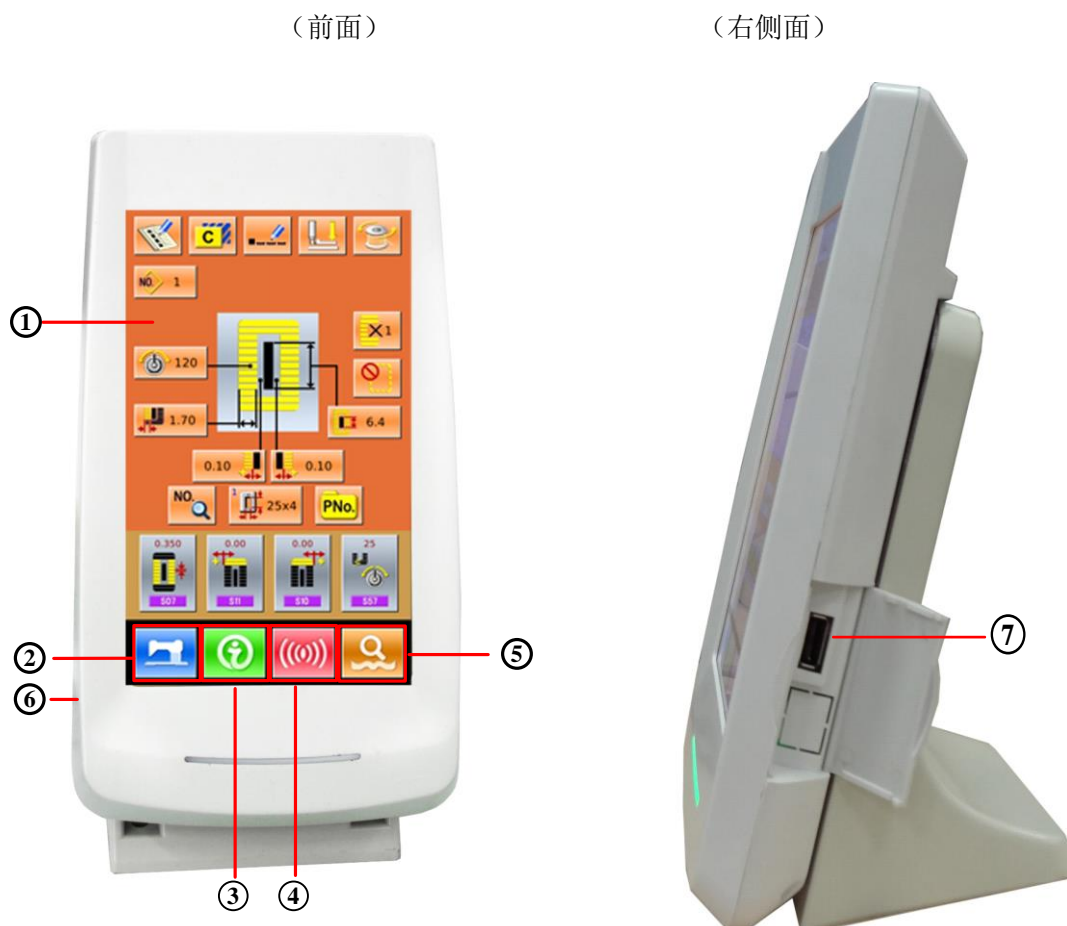

① 触摸盘晶显示部

②  准备键 → 进行数据输入界面和缝制界面的变换

③  信息键 → 进行数据输入界面和信息界面的变换

④  通信键 → 进行数据输入界面和通信界面的变换

⑤  模式键 → 进行数据输入界面和各种详细设定变换界面的变换

⑥ 电缆线

## ⑦ U盘插口

## 3.2 通用按键

各界面上进行通用操作的按键如下所示。

序号	图标	功能	备注
1		取消按键 → 退出当前设定界面。数据变更界面时，取消变更中的数据。	
2		确定按键 → 确定变更了的数据。	
3		加键 → 向上增加数值按键。	
4		减键 → 向下减小数值按键。	
5		复位按键 → 解除异常。	
6		数字输入按键 → 显示数字键盘，可以进行数字的输入。	

## 3.3 基本操作

## ① 打开电源开关

首先，请确认设定的压脚类型（A）和安装的压脚类型是否相同。

## ② 选择想缝制的图案 No.

打开电源之后，显示出数据输入界面。在界面上部显示出现在选择的图案No.，按键（B）之后可以选择图案No.。（没有登记的图案号不显示。）

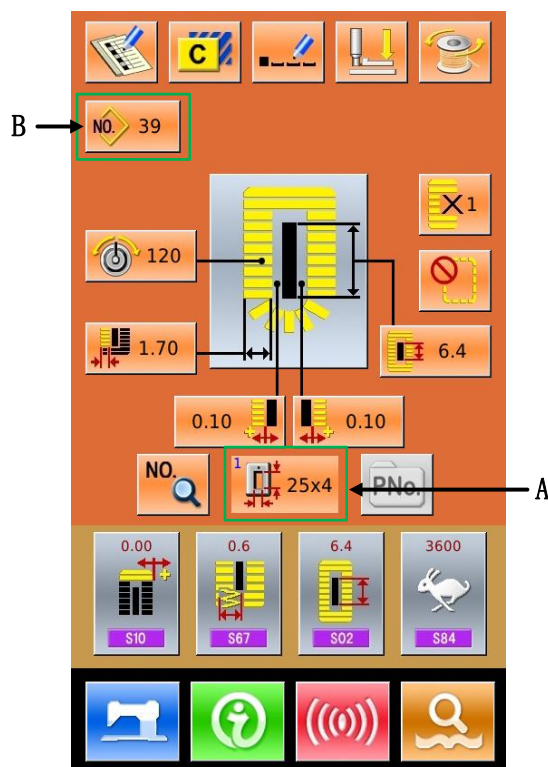

### ③ 设定成可以缝制的状态

按准备键之后，液晶显示的背景颜色变为蓝色，变成可以缝制的状态，右图中的A处是速度设置，B处是用户管理显示。

### ④ 开始缝制

把缝制品安放到压脚部，踩踏板，缝纫机启动，开始进行缝制。

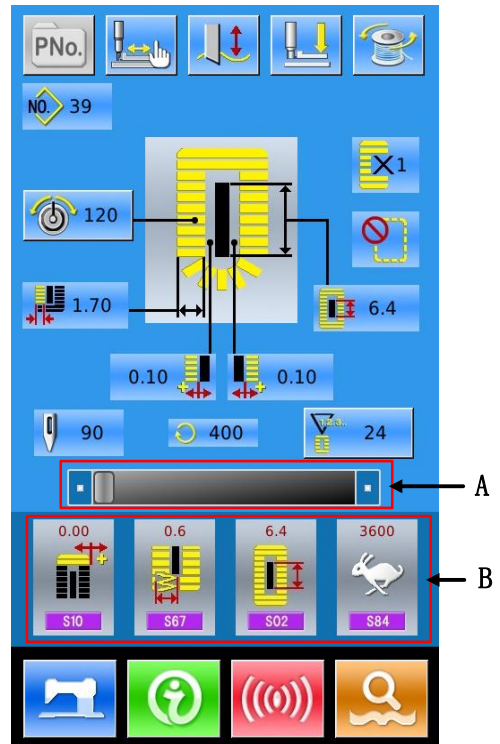

## 3.4 普通花样操作

普通花样设置和缝制界面如右图所示，各按键详细功能说明请见“4. 普通花样缝制”的介绍。

普通缝制方式是系统默认的方式，系统出厂时是普通缝制方式。

操作步骤：

- ① 按模式键进入模式设置



- ② 按缝制方式键  选择普通缝方式 
- ③ 按确定键 ，再按模式键  显示普通缝主界面

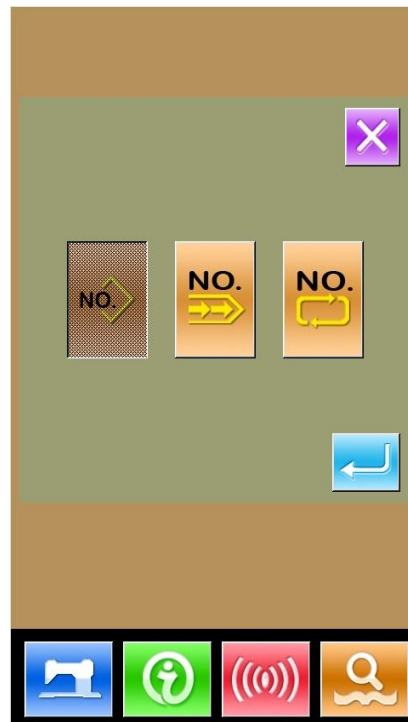

- ④ 选择所用的缝制形状
- ⑤ 设定必要的缝制参数
- ⑥ 选择压脚类型
- ⑦ 进行必要的编辑操作（登记、拷贝、命名等）

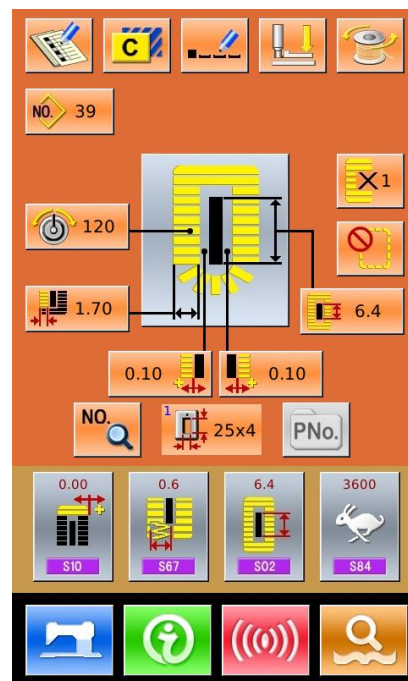

- ⑧ 按准备键  进入缝制界面准备缝制
- ⑨ 在缝制界面进行切刀、速度等设置
- ⑩ 进行计数器设置
- ⑪ 必要时选择试缝
- ⑫ 放下压脚、踩动踏板，进行缝制

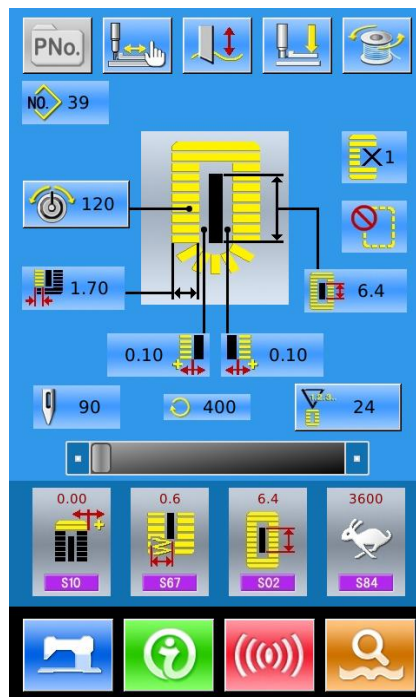

### 3.5 连续缝花样操作





连续缝操作的各界面如右图所示，界面的各按键的功能描述，参考“5. 连续缝花样缝制”

操作步骤：

- ① 按模式键  进入模式设置





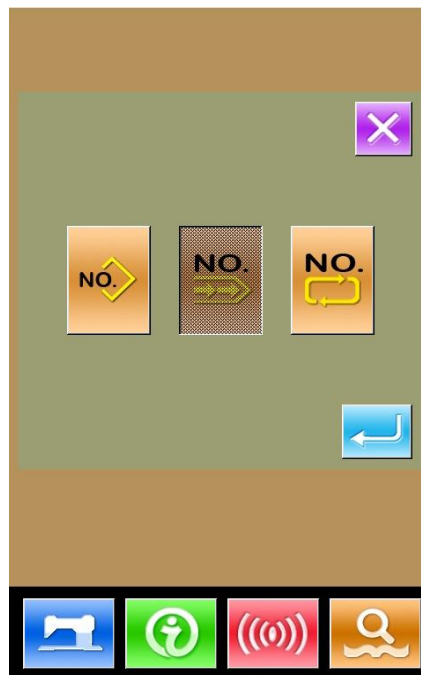

- ② 按缝制方式键  选择连续缝方式 
- ③ 按确定键 ，再按模式键  显示连续缝主界面

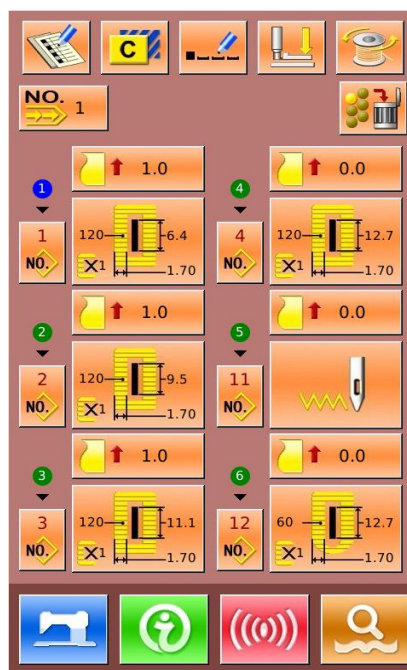

- ④ 在连续缝主界面下，添加连续缝使用的花样和送布量
- ⑤ 进行必要的编辑操作（复制、命名、添加、删除等）



- ⑥ 按准备键  进入缝制界面准备缝制
- ⑦ 在普通缝制界面进行切刀、速度等设置
- ⑧ 进行计数器设置
- ⑨ 必要时选择试缝
- ⑩ 放下压脚、踩动踏板，进行缝制

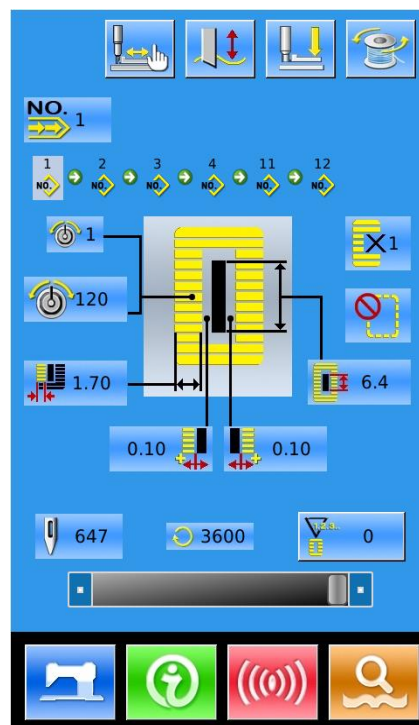

### 3.6 循环缝花样操作



循环缝操作的各界面如右图所示，界面的各按键的功能描述，参考“6. 循环缝花样缝制”

操作步骤：

- ① 按模式键  进入模式设置



② 按缝制方式键  选择循环缝方式 

③ 按确定键 , 再按模式键  显示循环缝主界面

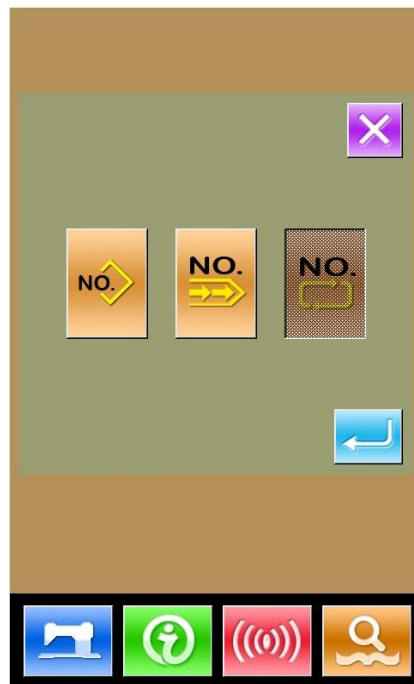

- ④ 在循环缝主界面下， 选择缝制织物
- ⑤ 移动缝制位置，添加循环缝使用的花样
- ⑥ 进行缝制花样缝制参数设置
- ⑦ 进行必要的编辑操作（复制、命名、添加、删除等）



- ⑧ 按准备键  进入缝制界面准备缝制
- ⑨ 在普通缝制界面进行切刀、速度、张力等设置
- ⑩ 进行计数器设置
- ⑪ 必要时选择试缝
- ⑫ 放下压脚、踩动踏板，进行缝制

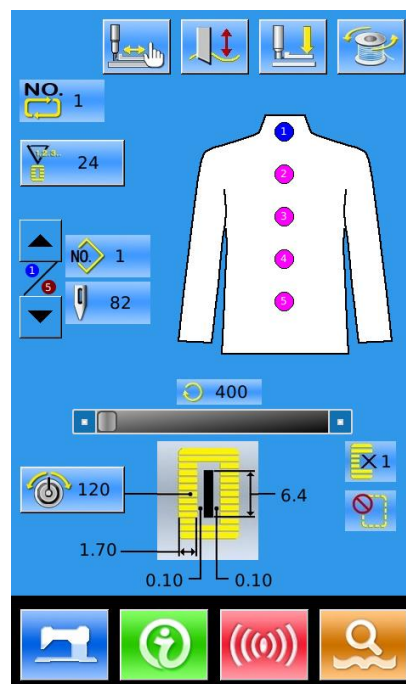

# 4 普通花样缝制

系统出厂时，默认方式是普通花样缝制方式，该方式的操作步骤在“3. 操作说明”中进行了描述，本节对普通花样缝制的各按键操作进行详细说明。

## 4.1 界面功能键

### (1) 缝制数据输入界面

数据输入界面如右图所示，详细功能说明请见功能键说明表。

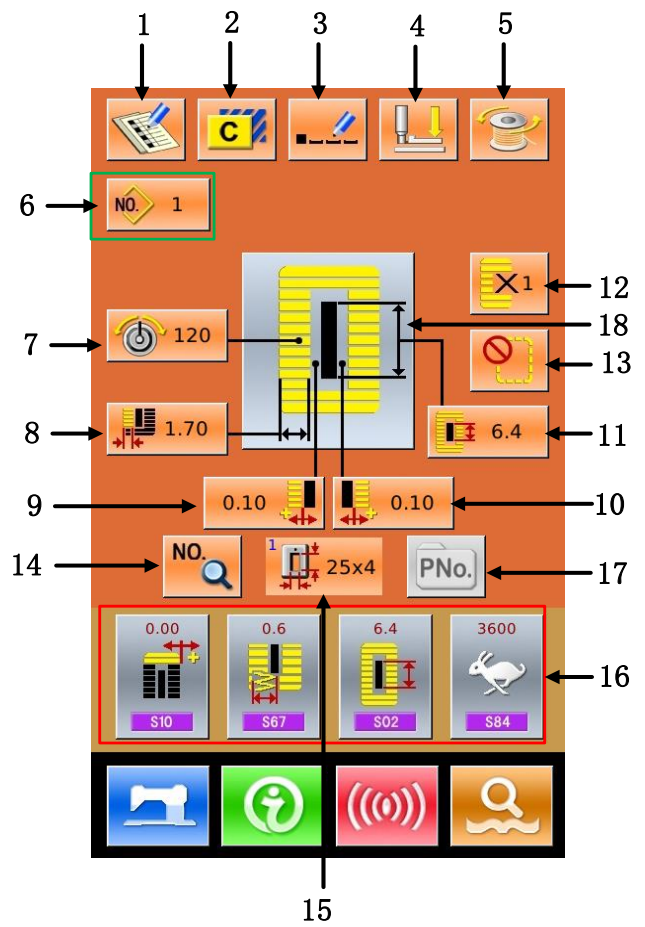

功能键说明表:

序号	图标	功能	备注
1		花样登记	
2		花样复制	
3		花样命名	

序号	图标	功能	备注
4		穿线（压脚下降）	可以在该状态下更换机针
5		绕线	
6		花样选择	按此键可进入花样选择界面
7		上线张力设定 (S51, S52, S55, S56)	S52 和 S56 受缝制数据开关影响
8		左包边宽度设定/返回宽度	1~26 号形状为左包边宽度设置, 27~30 号形状为返回宽度设定
9		切刀槽左宽度设定	27, 29 号形状不支持
10		切刀槽右宽度设定	27, 28 号形状不支持
11		切布长度	
12		双重缝/单次缝设置	27, 28, 29 号形状不支持
13		下缝次数设置	30 号形状不支持
14		缝制数据设置	
15		压脚类型选择	
16		用户管理	可把使用频率高的 4 个缝制数据设为快捷键放在主界面
17		直接选择键	
18		缝制形状选择	

(2) 缝制界面

按下  进入缝制界面如右图所示。详细功能说明请见功能键说明表。

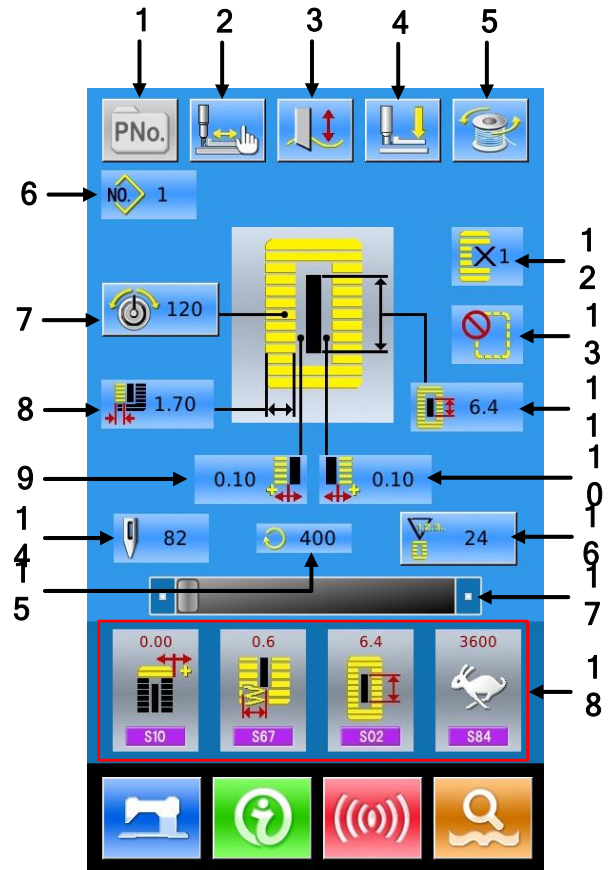

功能键说明:

序号	图标	功能	备注
1		P 花样选择按键	受 k18 参数控制
2		试缝	
3		 : 切刀使能  : 切刀禁止	切换切刀使能
4		穿线 (压脚下降)	
5		绕线	
6		花样号码显示	
7		上线张力张力设定	

序号	图标	功能	备注
8		左包边宽度显示	
9		切刀槽左宽度显示	
10		切刀槽右宽度显示	
11		切布长度显示	
12		单次缝/双重缝显示	
13		下缝次数显示	
14		总针数显示	
15		当前缝制速度显示	
16		计数器值显示 : 缝制计数器 : 计件计数器	
17		速度设置	受 k07 参数影响
18		用户管理显示	

## 4.2 花样登记

最多可以登记普通花样 500 个。按下 进入花样登记界面（如右图所示）：

### ① 输入花样号

通过数字键可以选择想要输入的花样号码，如果输入了已经存在的花样号码，界面上方会显示出被登记的缝制形状及相关数据，已经登记的花样

号码不能重复登记。通过 ， 键可以检索未登记的花样号码。

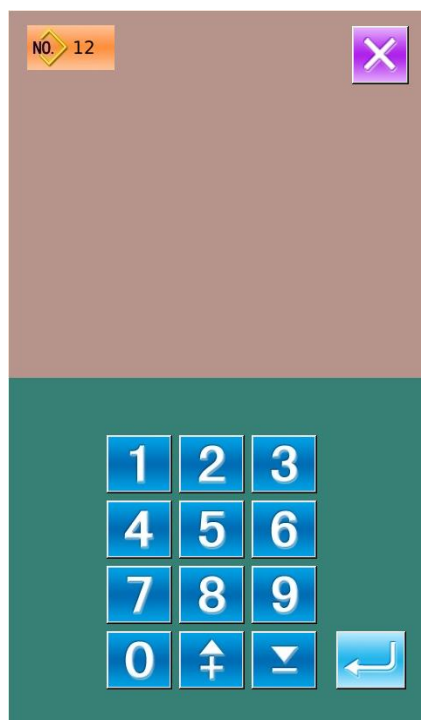



## ② 选择第一固定缝形状

确定花样号码后按下 , 则进入第一固定缝形状选择界面 (如右图所示)。

按退出键  直接退出选择。

注: 缝制形状数量受参数K04影响, 参阅第4.9节缝制形状选择部分。



## ③ 结束缝制形状选择

选择好第一固定缝形状后则进入结束形状的选择界面 (如右图所示)。

按下  则完成了新花样的登记并返回主界面, 根据选择的缝制形状, 设置缝制数据初始值。

按退出键  直接退出选择。

注: 1. 缝制形状数量受参数 K04 影响, 参阅第 4.9 节缝制形状选择部分。

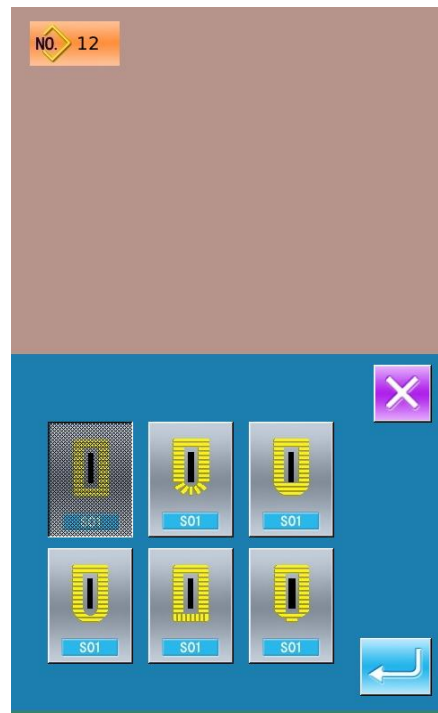

## 4.3 花样复制

### ① 选择被复制花样

按下  进入花样复制界面（如右图所示）。

A、在已登记的花样中选择被复制花样号码并按

下 ，进入登记号码输入界面。

B、按退出键  直接退出花样复制

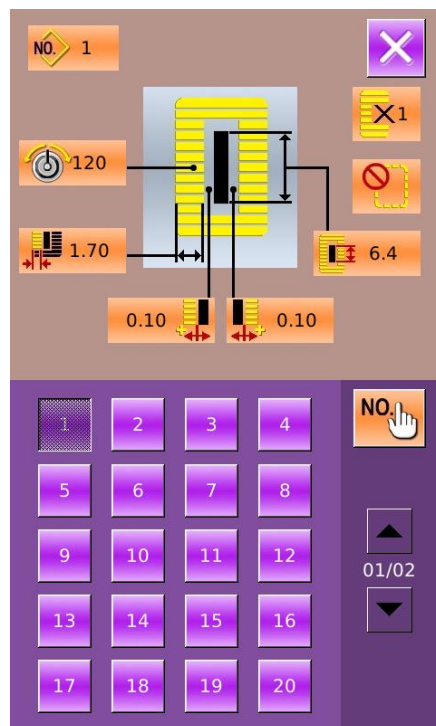

### ② 输入新登记的花样号码

界面上方显示为被复制花样缝制形状和相关缝制数据，通过数字键选择未登记的花样号码，已经登记的花样号码不能重复登记。

A、按下  则完成花样复制操作，并返回花样复制界面。

B、按退出键  直接退出号码输入界面

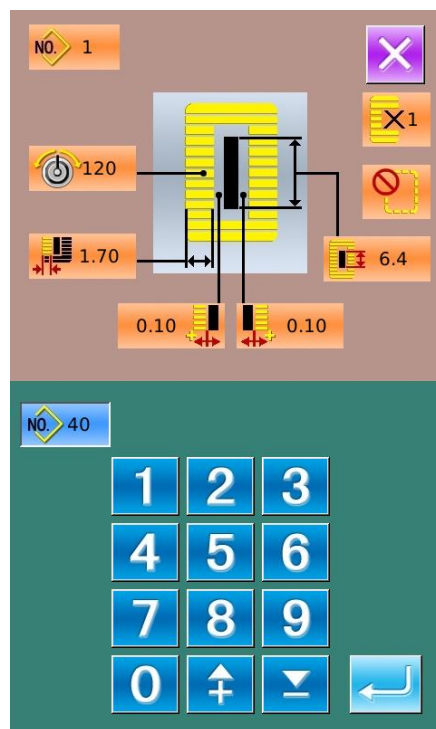



## 4.4 花样命名

按下  进入花样命名界面（如右图所示），最多可以输入 12 个字符。

 : 光标右移键

 : 光标左移键

 : 字母大小写切换键

 : 清除键

A、选择想要输入的字符，按下  结束花样命名操作。

B、通过移动光标可以确定该字符位置，清除键可以消除该位置字符。

C、按下退出键  直接退出。

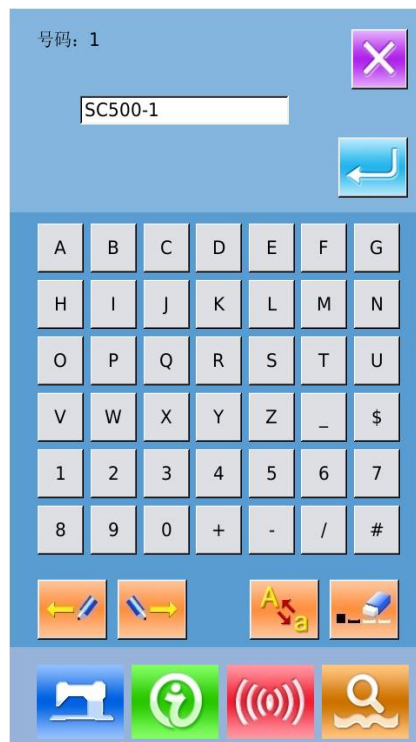

## 4.5 穿线

按下  进入穿线界面，此时压脚下降，按下穿线界面下的压脚上升键则压脚上升并返回主界面。

 : 压脚下降

 : 压脚上升

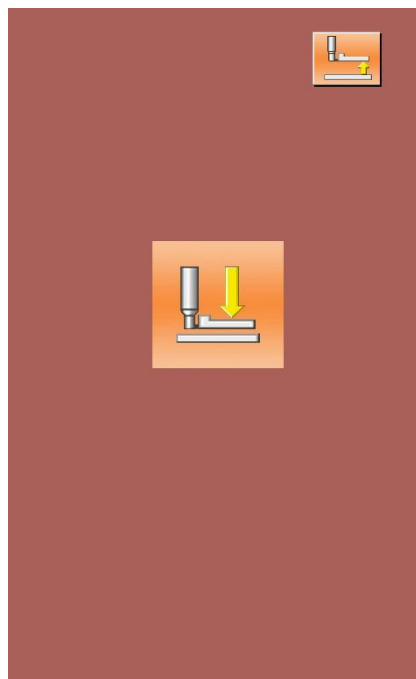

## 4.6 绕线

### ① 安装梭芯

把梭芯插进绕线轴。然后，请朝箭头方向按梭芯导向器（如右图所示）。

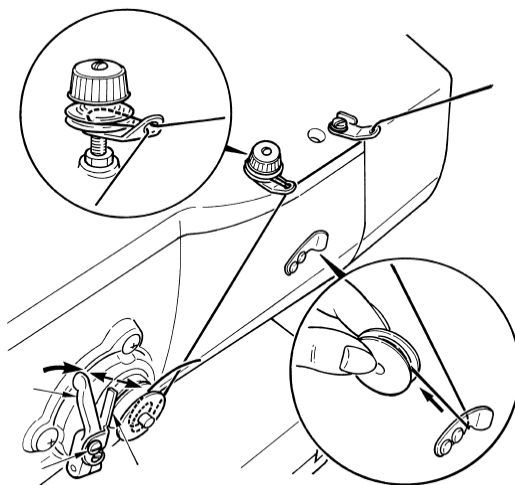

### ② 显示底线绕线界面

在数据输入界面(橙色)或缝制界面(蓝色)上, 按了绕线按键  之后, 绕线界面被显示出来 (如右图所示)。

### ③ 开始绕线

踩踏启动踏板之后, 缝纫机转动, 开始卷绕底线。

### ④ 停止缝纫机

按了停止按键  之后, 缝纫机停止转动, 返回通常模式。另外, 在卷绕底 中, 再次踩踏踏板之后, 缝纫机在绕线模式下停止缝纫机, 因此再次踩踏启动踏板, 可以继续卷绕底, 在卷绕数个梭芯时可以利用此功能。



## 4.7 选择压脚类型

### ① 显示数据输入界面



仅数据输入界面(橙色)可以变更设定内容。如果显示的是缝制界面(蓝色)时, 请按准备键, 显示出数据输入界面。

### ② 调出压脚类型选择界面

按了压脚类型选择按键 (A) 之后, 显示出压脚类型选择界面 (如右图所示)。

### ③ 选择压脚类型

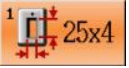
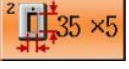
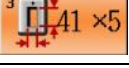
请按安装在缝纫机上的压脚类型的按键(B)。被按的按键翻转显示。关于压脚类型, 请参考下表进行设定。

	类型	压脚型号
	1 型	
	2 型	
	3 型	
	5 型	—

※ 使用 1 ~ 3 型以外的压脚头时, 请设定为 5 型。请根据使用的参数 U15 压脚和宽度参数 U16 压脚长度, 变更存储器开关(1 级)。使用 5 型压脚摆动宽度最大可达 6mm, 长度在 41mm 以上时, 需要变更压脚曲柄、送布板等零件。

### ④ 确定压脚类型

按确定按键  之后, 退出压脚类型变更界面,

变更完成。按退出键  直接退出

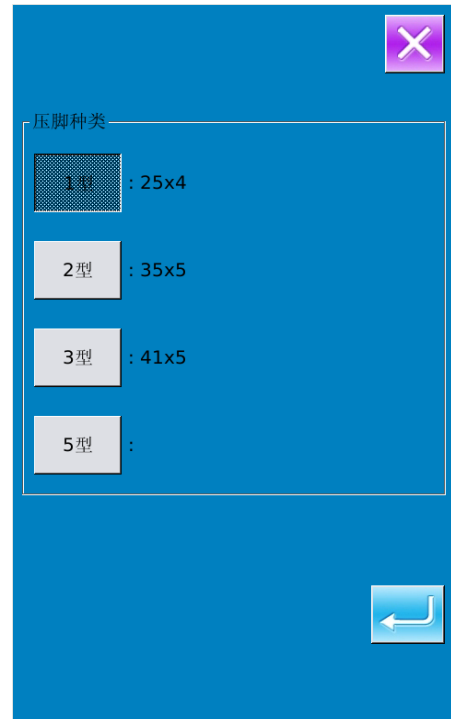
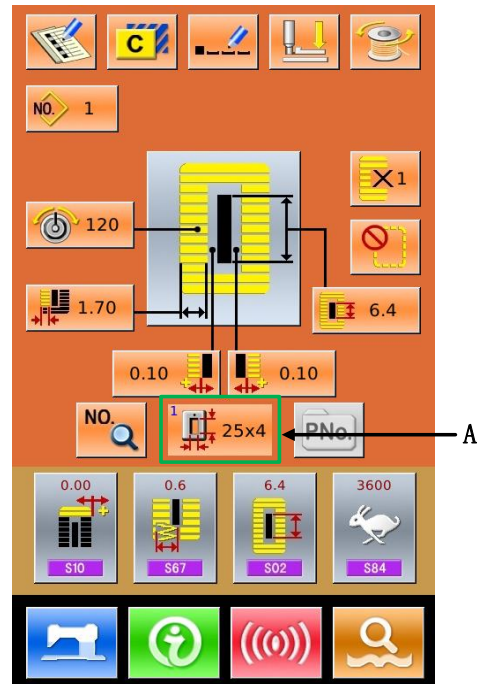

## 4.8 花样选择

按下  进入花样选择界面（如右图所示），上方为当前选择花样的缝制形状和相关数据，下方为已登记的花样号码。

：输入号码查询花样

：花样删除

### ① 选择花样

每页可以显示20个花样号码，超过一页时通过【上/下翻页键】进行翻页。选中已登记的花样号码时，上方会显示已选择花样内容。

按下  完成花样选择操作。

按退出键  直接退出花样选择。

### ② 花样查询

按下  会弹出花样查询界面，通过数字键可以直接输入花样号码，如图2所示。

### ③ 花样删除

选中已登记的花样，按下  就会删除掉该花样，但是以下三种情况下的花样是不能被删除的。

- A: 连续缝中被包含的花样
- B: 循环缝中被包含的花样
- C: 被登记到 P 的花样也不能被删除



图 1



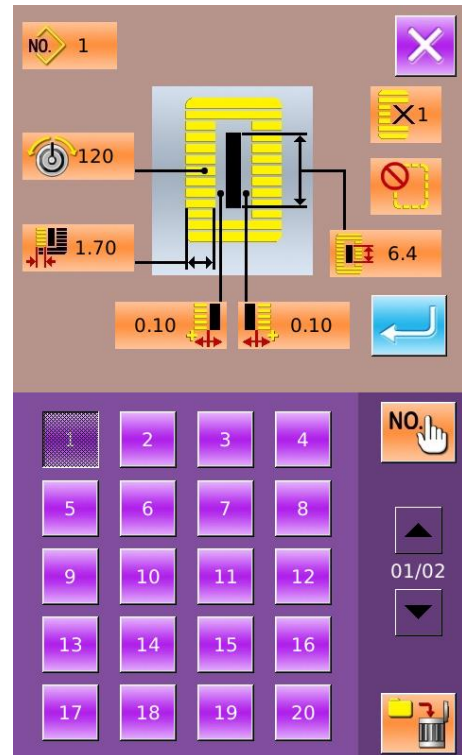

图 2

## 4.9 缝制形状选择

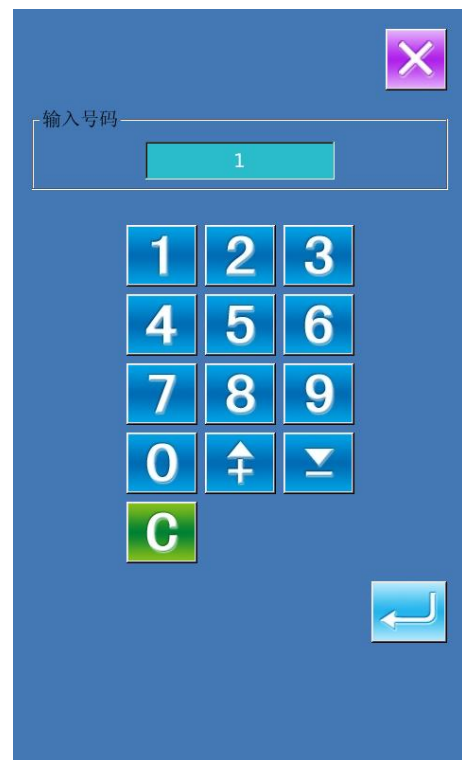

按下进入缝制形状选择界面。

### ① 选择第一固定缝形状

常用的5种第一固定缝形状分别代表方型、放射型、圆眼型、半圆型、圆型，当参数K04设置为30种缝制形状时，还可以选择加固缝、加固左切断、加固右切断、加固中央切断4种类型。选择第一固定缝形状进入缝制形状选择，其中27~30

号形状可以按下结束选择。

按退出键直接退出。

- 注：1. 第一固定缝形状的显示受K04参数的影响；  
 2. 改变第一固定缝形状时，请注意修改对应该形状的缝制参数，否则有可能影响打板数据生成或缝制效果；  
 3. 形状的初始参数数值，请参考附录1的10.4节“缝制初始值数据一览表”

### ② 结束缝制形状选择

选择结束缝制形状，按下返回主界面。

按退出键直接退出，不改变形状号。

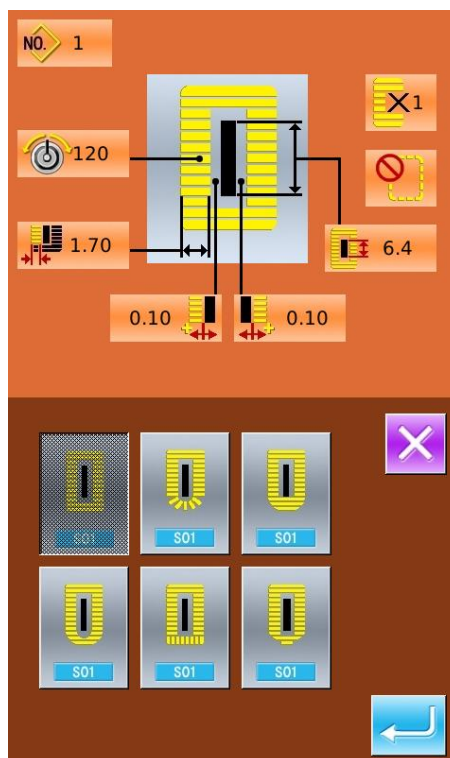
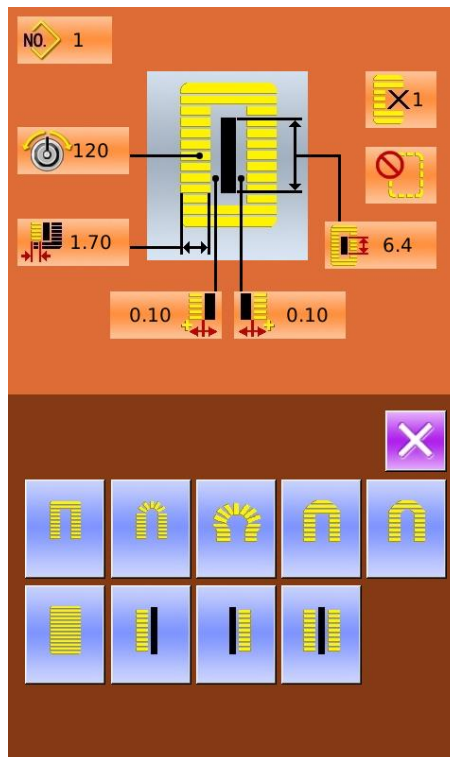































③参数 K04 影响

	K04 = 12 个形状	K04 = 20 个形状	K04 = 30 个形状
方型	1	1, 18, 19, 20	1, 18, 19, 20, 21, 22
放射型	3, 4, 5, 6	3, 4, 5, 6	3, 4, 23, 24, 5, 6
圆眼型	7, 8, 9, 10	7, 8, 16, 17, 9, 10	7, 8, 16, 17, 9, 10
半圆型	11	13, 11, 14, 15	13, 25, 11, 26, 14, 15
圆型	12, 2	12, 2	12, 2
加固型			27, 28, 29, 30

注 1: 表中数字代表形状号码。

注 2: 缝制形状 27, 28, 29, 30 只有在 K04 设置为 30 个形状时才可以被使用。

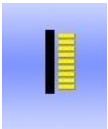
④缝制形状一览

01 方形 	02 圆形 	03 放射方形 	04 放射形 	05 放射直线固定型 
06 放射锥形固定形 	07 圆眼方形 	08 圆眼放射形 	09 圆眼直线加固形 	10 圆眼锥形加固形 
11 半圆形 	12 圆方形 	13 半圆方形 	14 半圆直线加固形 	15 半圆锥形加固形 
16 圆眼半圆形 	17 圆眼圆形 	18 方放射形 	19 方半圆形 	20 方圆形 
21 方直线加固形 	22 方锥形加固形 	23 放射半圆形 	24 放射圆形 	25 半圆放射形 
26 半圆圆形 	27 加固缝 	28 加固右切断 	29 加固左切断 	30 加固中央切断 



### 4.10 缝制数据设置

#### ① 变更缝制数据

按下  进入缝制设置界面（如右图所示）。  
 选择想要修改的缝制数据后进入设置状态，参数号底色为**紫色**的缝制数据是数据输入类型，参数号底色为**蓝色**的缝制数据是图标选择类型。

按下  退出缝制数据设置。

举例如下：

选择  S02，进入界面（如右图所示）

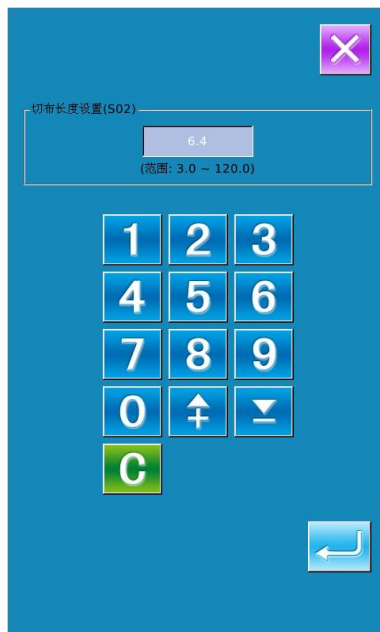
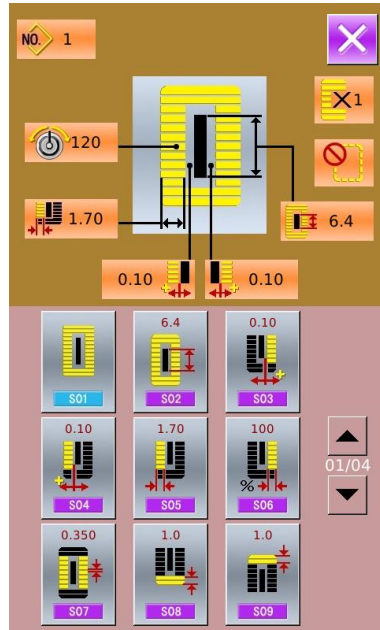



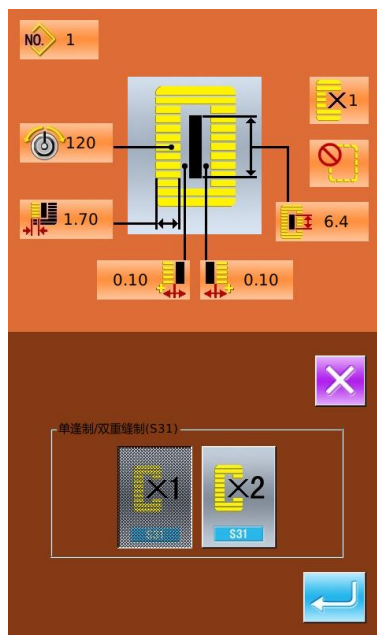

选择 ，进入界面（如右图所示）









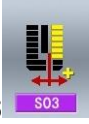
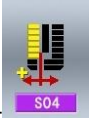
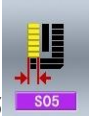









## ② 缝制数据表













缝制数据与选择的缝制形状是有关系的，形状不同可设置的缝制数据不同，并且缝制数据初始值也可能不同。











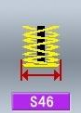



模式状态下可以编辑部分缝制数据是否打开。另外还有部分缝制数据是受其它缝制数据影响的。

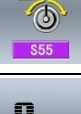

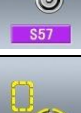









号码	项目	设定范围	编辑单位	备注
 S01	缝制形状 参照第 2.12 节缝制形状选择。	1~30	1	注 5
 S02	切布长度 设定切布刀切断缝制品的长度。缝制形状为 27、28、29、30 时为设定缝制长度。 把参数 U19（切布刀数次动作）设定为有效，然后按照 U18（切布刀尺寸）设定的切刀尺寸数次地切断缝制品。	3.0~120.0	0.1mm	
 S03	切刀槽右宽度 设定切刀和右平行部的间隙。	-2.00~2.00	0.05mm	
 S04	切刀槽左宽度 设定切刀和左平行部的间隙。	-2.00~2.00	0.05mm	
 S05	左包边宽度 设定左平行部的包边宽度。	0.10~5.00	0.05mm	

号码	项目	设定范围	编辑单位	备注
 S06	左右形状比率 设定以切刀位置为中心的右侧形状扩大缩小率。	50~150	1%	
 S07	平行部间距 设定左右平行部的缝制间距。	0.200~2.500	0.025mm	
 S08	第2加固缝长度 设定前侧加固缝部的长度。 方形下  直线加固下  锥形下 	0.2~5.0	0.1mm	
 S09	第1加固缝长度 设定里侧加固缝部的长度。 方形上 	0.2~5.0	0.1mm	
 S10	右加固宽度修正 对加固部的右侧外形包边缝部进行调整。 第1, 第2加固均被修正。 方形上  方形下  直线加固下 	-1.00~1.00	0.05mm	
 S11	左加固宽度修正 对加固部的左侧外形包边缝部进行调整。	-1.00~1.00	0.05mm	
 S12	左锥形加固对称 设定形成锥形加固形状的加固部长度。	0.00~3.00	0.05mm	注 1
 S13	右锥形加固对称 设定形成锥形加固形状的加固部长度。	0.00~3.00	0.05mm	注 1
 S14	圆眼形状长度 设定圆眼形状的圆眼孔中心到上侧的长度。	1.0~10.0	0.1mm	注 1
 S15	圆眼形状针数 设定圆眼形状的上部 90 度中的缝制针数。	1~8	1	注 1
 S16	圆眼宽度 设定圆眼形状的内侧的横尺寸。 实际的落针点是加上 S04 左切刀槽宽度后的尺寸。	1.0~10.0	0.1mm	注 1
 S17	圆眼长度: 设定圆眼形状的内侧的纵尺寸。	1.0~10.0	0.1mm	注 1

号码	项目	设定范围	编辑单位	备注
S18 	圆型形状长度：设定圆型形状中心到上侧的长度。 圆形上  放射上  半圆上  圆形下  放射下  半圆下 	1.0~5.0	0.1mm	注 1
S19 	放射形状针数 设定放射形状的上部 90 度中的缝制针数。	1~8	1	注 1
S20	放射形状加固：设定有/无放射形状加固  ：无  ：有			注 1 注 2
S21 	加固部间距：设定加固部的缝制间距。 方形上  圆形上  半圆上  方形下  圆形下  半圆下  直线加固下  锥形下 	0.200~2.500	0.025	
S22 	第 1 间隙 设定第 1 加固和切刀槽间的间隙。适用于全形状。	0.0~4.0	0.1mm	
S23 	第 2 间隙 设定第 2 加固和切刀槽间的间隙。适用于全形状。	0.0~4.0	0.1mm	
S31	单缝制/双重缝制  ：单缝制  ：双重缝制			
S32	选择双重缝制交叉 设定双重缝制时，选择重叠缝制平行部落针或交叉缝制。  ：双重缝制  ：交叉缝制			注 3
S33 	修正双重缝制宽度 设定双重缝制时，设定缩小第 1 圈的包边宽度量。	0.0~2.0	0.1mm	注 3

号码	项目	设定范围	编辑单位	备注
S34	下缝次数：设定下缝次数。  : 无下缝  : 1~9 次	0~9	1 次	
S35	 : 下缝间距 设定下缝时的缝制间距。	1.0~5.0	0.1mm	注 3
S36	 : 下缝卷入长度 设定进行下缝时的上线卷入缝制长度。	2.0~20.0	0.1mm	注 3
S37	 : 下缝卷入间距 设定进行下缝时的上线卷入缝制间距。	0.2~5.0	0.1mm	注 3
S38	 : 下缝卷入宽度 设定进行下缝时的上线卷入缝制宽度。	0.0~4.0	0.1mm	注 3
S39	 : 下缝落针前后修正 进行 2 圈以上的缝制时，设定落针点的前后修正量。	0.0~2.5	0.1mm	注 2 注 3
S40	 : 下缝落针左右修正 进行 2 圈以上的下缝时，设定落针点的左右修正量。	0.0~1.0	0.1mm	注 3
S41	 : 下缝左侧位置修正 设定从左包边中心左右修正下缝的缝制基准位置的修正量。	-2.0~2.0	0.1mm	注 2 注 3
S42	 : 下缝右侧位置修正 设定从右包边中心左右修正下缝的缝制基准位置的修正量。	-2.0~2.0	0.1mm	注 2 注 3
S44	 : 下缝速度的设定 设定下缝速度。	400~4200	100rpm	注 3 注 4
S45	对缝功能：选择最初进行缝制。  : 有对缝  : 无对缝 选择了有对缝后，按照对缝->下缝->通常缝制的顺序进行缝制。			

号码	项目	设定范围	编辑单位	备注
S46 	对缝宽度 设定进行对缝时的缝制宽度。	1.0~10.0	0.1mm	注 2 注 3
S47 	对缝间距 设定进行对缝时的缝制间距。	0.2~5.0	0.1mm	注 2 注 3
S51 	左平行部张力 设定左平行部的上线张力。	0~200	1	
S52 	右平行部张力 设定右平行部的上线张力。	0~200	1	注 2
S53 	左平行部张力（双重缝的第 1 圈） 双重缝时，设定第 1 圈的左平行部上线张力。	0~200	1	注 2 注 3
S54 	右平行部张力（双重缝的第 1 圈） 双重缝时，设定第 1 圈的右平行部张力。	0~200	1	注 2 注 3
S55 	第 1 加固部张力 设定第 1 加固部的上线张力。	0~200	1	
S56 	第 2 加固部张力 设定第 2 加固部的上线张力。	0~200	1	注 2
S57 	设定缝制开始的上线张力 设定缝制开始时加固缝的上线张力。	0~200	1	
S58 	设定下缝的上线张力 设定下缝的上线张力。	0~200	1	注 3
S59 	第 1 加固开始，ACT 同步调整 调整第 1 加固部的上线张力输出开始同步。	-5~5	1 针	注 2
S60 	右包边开始，ACT 同步调整 调整包边缝制部的上线张力输出开始同步。	-5~5	1 针	注 2
S61 	第 2 加固开始，ACT 同步调整 调整第 2 加固部的上线张力输出开始同步。	-5~5	1 针	注 2
S62 	缝制开始固定缝制针数 设定缝制开始加固缝制的针数。	0~8	1 针	

号码	项目	设定范围	编辑单位	备注
 S63	缝制开始固定缝制间距 设定缝制开始加固缝制的缝制间距。	0.00~0.70	0.05mm	注 2
 S64	缝制开始加固缝制宽度 设定缝制开始加固缝制的宽度	0.0~3.0	0.1mm	
 S65	缝制开始加固缝制的纵修正 设定缝制开始加固缝制的总方向开始位置。	0.0~5.0	0.1mm	注 2
 S66	缝制开始加固缝制的横修正 设定缝制开始加固缝制的横方向开始位置。	0.0~2.0	0.1mm	注 2
 S67	缝制结束加固缝制宽度 设定缝制结束加固缝制的宽度。	0.1~1.5	0.1mm	
 S68	缝制结束加固缝制针数 设定缝制结束加固缝制的针数。	0~8	1 针	
 S69	缝制结束加固缝制纵修正 设定缝制结束加固缝制的纵方向开始位置。	0.0~5.0	0.1mm	注 2
 S70	缝制结束加固缝制横方向修正 设定缝制结束加固缝制的横方向开始位置。	0.0~2.0	0.1mm	注 2
S81	切刀动作：设定通常的切布刀有/无动作。  S81：通常切刀动作关闭  S81：通常切刀动作打开			
S83	双重缝制的第 1 圈切刀 双重缝时，设定第 1 圈的切布刀有/无动作。  S83：通常切刀动作关闭  S83：通常切刀动作打开			注 2 注 3

号码	项目	设定范围	编辑单位	备注
 S84	最高速度限制 设定缝制机的最高转速。 受参数 K07（最高转速限制设定）限制。	400~4200	100rpm	注 4
 S86	前进间距 设定条形（S01 的形状 N0.27, 28, 29, 30）前进侧的缝制间距。	0.200~2.500	0.025	注 1
 S87	前进宽度 设定条形（S01 的形状 N0.27, 28, 29, 30）前进侧的缝制宽度。	0.10~3.00	0.05mm	注 1
 S88	返回间距 设定条形（S01 的形状 N0.27, 28, 29, 30）返回侧的缝制间距。	0.200~2.500	0.025mm	注 1
 S89	返回宽度 设定条形（S01 的形状 N0.27, 28, 29, 30）返回侧的缝制宽度。	0.10~3.00	0.05mm	注 1

注 1: 形状不同显示也不同。

注 2: 编辑下设定为打开后显示。

注 3: 选择了功能之后显示

注 4: 受参数 K07（最高转速限制设定）限制

注 5: 改变第一固定缝形状时, 请注意修改对应该形状的缝制参数, 否则有可能影响打板数据生成或缝制效果



### 4.11 直接选择花样

可以登记 10 个常使用的花样到直接选择按键上，按下

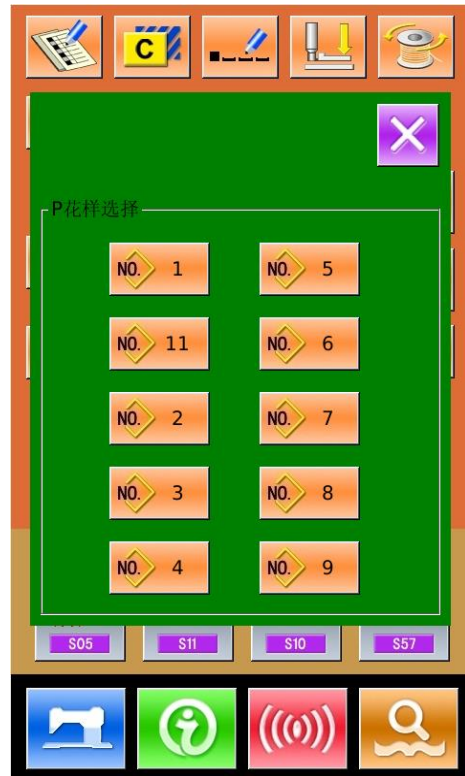

### 4.12 试缝操作

#### (1) 显示缝制界面

在数据输入界面，按准备键之后，液晶显示的背景颜色变为蓝色，此时进入缝制界面。

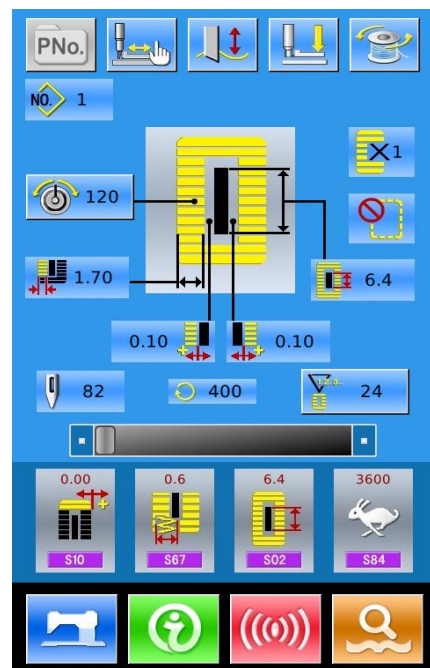



## (2) 显示试缝界面

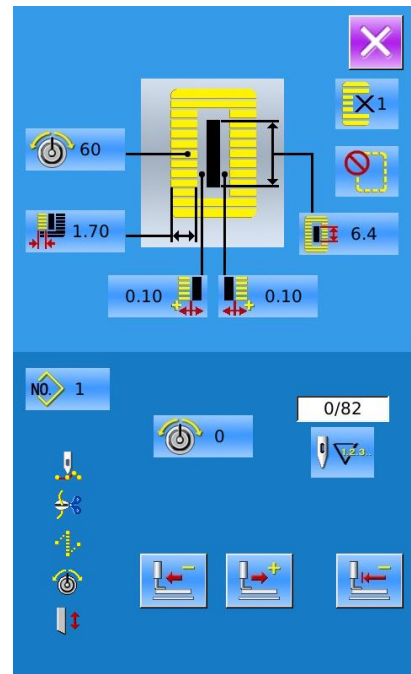

在缝制界面下，按下键后进入试缝界面（如图右图所示）：

- ：返回原点
- ：后退
- ：前进
- ：落针点张力
- ：当前针数/总针数
- ：缝制指令
- ：切线指令
- ：空送指令
- ：线张力指令
- ：切刀驱动指令



## (3) 开始试缝

A、通过点按返回原点键、后退键和前进键三个键开始单步试缝。此模式时，脚踩脚踏板开关，缝纫机起动缝完剩余的针数。

B、长按、时，此时将试缝整个花样。  
C、试缝执行时，根据缝制数据，左侧的相应指令标志会加灰显示。

例如：当缝制数据是剪线时，图标变为。

## (4) 结束试缝

按了取消键退出试缝界面之后，返回缝制界面。

## 4.13 上线张力设置

### 变更线张力值时

#### ① 显示数据输入界面



在数据输入界面（橙色）或缝制界面(蓝色)上，可以变更上线张力。如果是在缝制界面(蓝色)时，请按准备键，显示出数据输入界面(橙色)。



#### ② 叫出上线张力变更界面

按了上线张力按键之后，上线张力变更界面被显示出来（如右图所示）。

#### ③ 变更上线张力

在上线张力变更界面上，可以变更平行部上线张

力和加固部上线张力。通过选择，，

，可以分别设定S51, S52, S55, S56，其中S52, S56是可以在模式状态下编辑缝制数据中被关闭的。

点按【线张力1】【线张力2】可在两组张力值间切换。

#### ④ 结束上线张力的变更

按了取消按键之后，关闭上线张力变更界面，结束变更。

※ 平行部和加固部以外的张力变更。

① 平行部张力，②加固部张力的设定值



	操作盘设定值			
		⊕	初期值	⊖
锯齿边缝	①平行部张力	下降锯齿高度	1 2 0	提高锯齿高度
	②加固部张力	下张力	3 5	上线张力
直线锁眼	①平行部张力	下张力	6 0	上线张力
	②加固部张力	下张力	6 0	上线张力

放射圆眼形状时，把加固张力最初设定为120 左右，请平衡缝迹。

关于锯齿边缝和直线锁眼

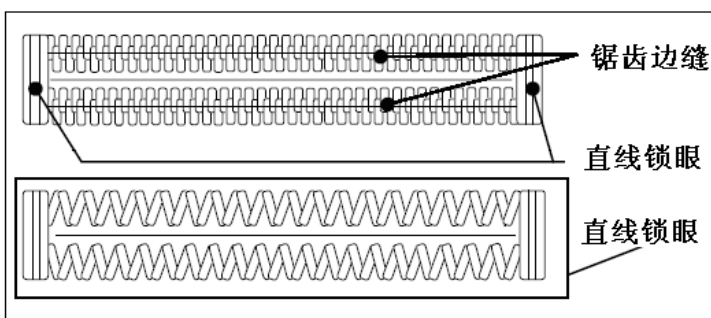

锯齿边缝

增强上线张力，在上线缝迹中心直线通过的左右缝制锯齿边缝迹。



直线锁眼

在布表面仅缝上线，布背面仅缝下线的往返缝迹。

## 4.14 计数器操作

### (1) 计数器的设定方法

#### ① 显示计数器界面

在缝制界面中，按了  (  ) 键之后，计数器设定界面被显示出来。



: 缝制计数器类型



: 计件计数器类型

通过选择  和  可以设置计数器类型，并且设置其当前计数值。





A、按下 设置生效，并返回主界面。

B、按下 取消操作，并返回主界面。

## 4.15 急停

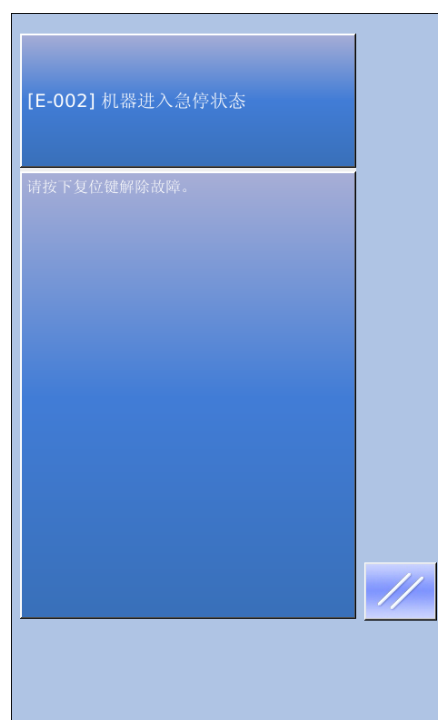
缝制过程中，按下停止开关后，缝纫机中断缝制，停止转动。此时显示界面如右图所示：



按下  解除异常，弹出单步动作界面（如右图所示）。

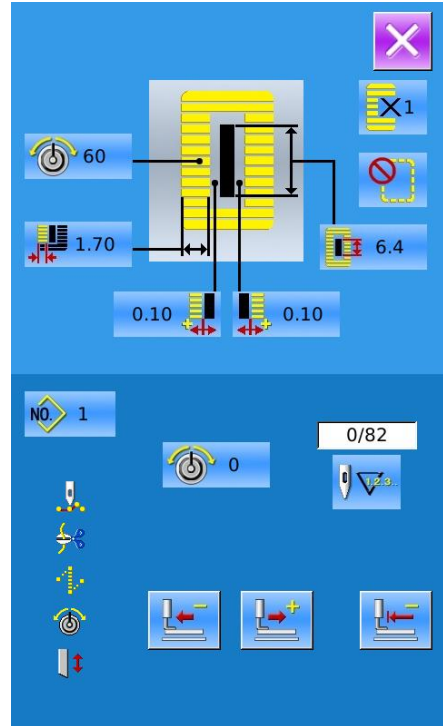



操作设置同试缝状态。踩下踏板可以继续缝纫。

## 4.12 VDT 花样操作

### 4.12.1 VDT 花样显示与操作

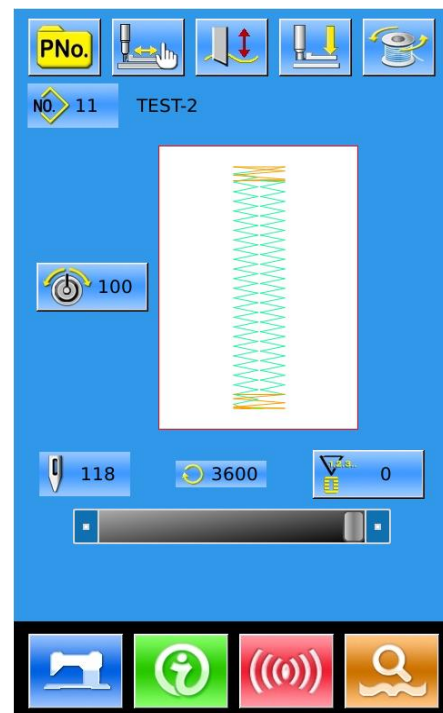
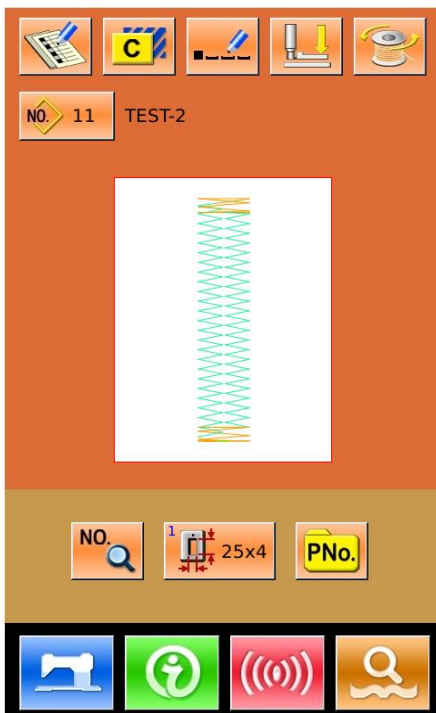
可以利用打版软件生成 VDT 类型花样，通过 U 盘导入到内存中后，其数据输入界面和缝制界面如下：



按下  进入缝制数据设置界面，如右图所示：



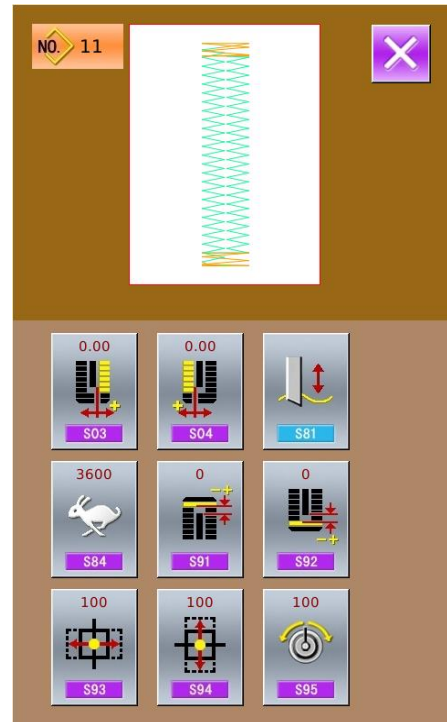

按下  取消操作，并返回主界面。



### 4. 12. 2 VDT 花样缝制数据表

VDT 类型花样缝制数据表：

号码	项目	设定范围	编辑单位	初始值
 S03	切刀槽右宽度 设定切刀和右平行部的间隙。	-2.00~2.00	0.05mm	0
 S04	切刀槽左宽度 设定切刀和左平行部的间隙。	-2.00~2.00	0.05mm	0
S81	切刀动作：设定通常的切布刀有/无动作。  S81：通常切刀动作关闭  S81：通常切刀动作打开			通常切刀动作打开
 S84	最高速度限制 设定缝制机的最高转速。 受参数 K07（最高转速限制设定）限制。	400~4200	100rpm	参数 K07

号码	项目	设定范围	编辑单位	初始值
 S91	第 1 间隙修正	-9~9	1 针	0
 S92	第 2 间隙修正	-9~9	1 针	0
 S93	放大缩小率 (X 方向)	20~200	1%	100
 S94	放大缩小率 (Y 方向)	20~200	1%	100
 S95	张力基准值	0~200	1	100



## 5 连续缝花样缝制

这种缝制类型不提升压脚连续缝制最多 6 种形状。  
最多可以登记 50 个连续缝花样。

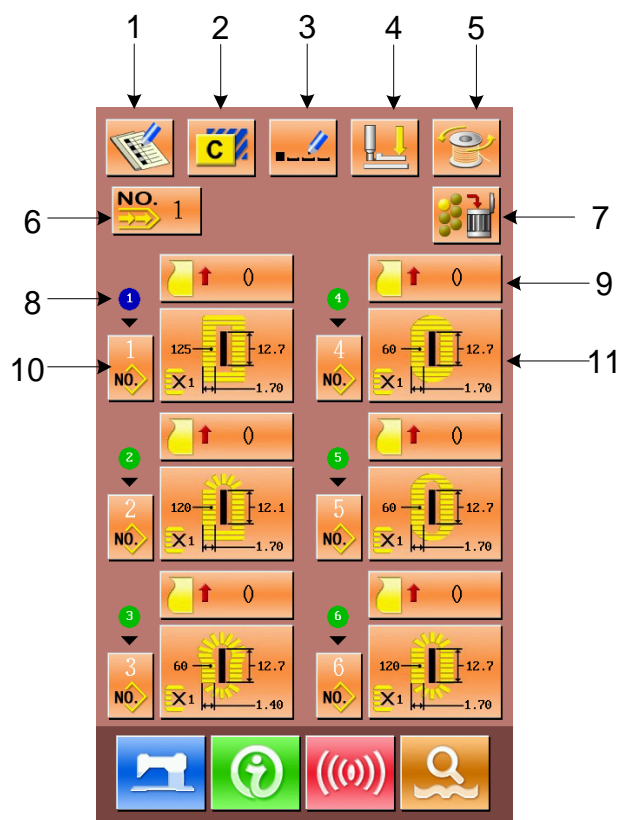

### 5.1 功能说明

序号	图标	功能	备注
1		新花样登记	
2		花样复制	
3		花样命名	
4		穿线	
5		绕线	
6		连续缝花样选择	
7		全部消除键	消除当前连续缝花样的全部子花样数据
8		缝制顺序	

序号	图标	功能	备注
9		送布量输入键	
10		子花样选择键	
11		缝制数据编辑	

## 5.2 连续缝编辑

### 5.2.1 连续缝花样选择

按下 可以进入花样选择界面（如右图所示）。

通过下面的方式进行操作：

A、可以通过 ， 查看连续缝制数据里登记的花样信息。

B. 按直接选择键 ，通过输入号码进行选择

C、按删除键 可以删除选中的花样

D、选择合适的花样，按下 结束选择，并返回主界面。

E、按下 取消选择操作，并返回主界面。

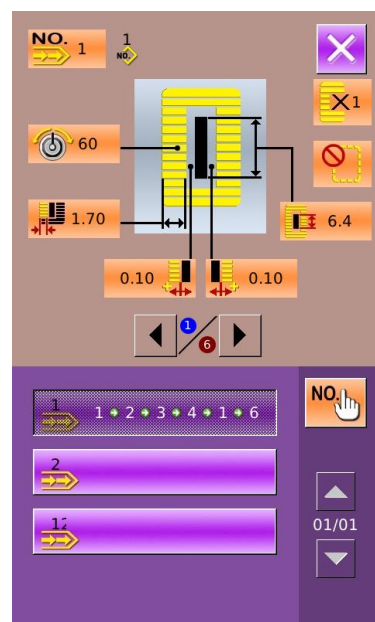

### 5.2.2 连续缝花样编辑

#### ① 送布量设置

按下图 1 中的 键进入送布量设置界面（如图 2 所示）。



图 2



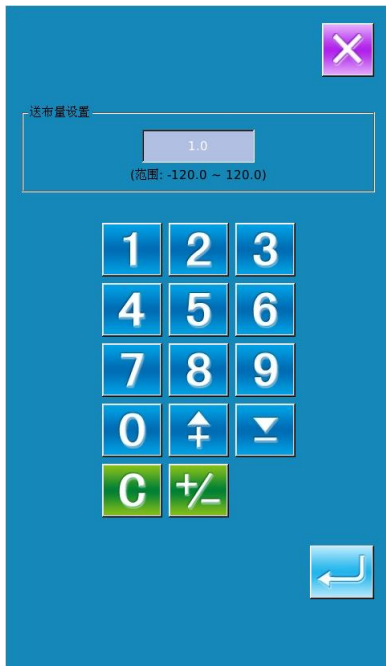

图 1

② 选择花样

按下  进入花样选择界面（如右图所示）。

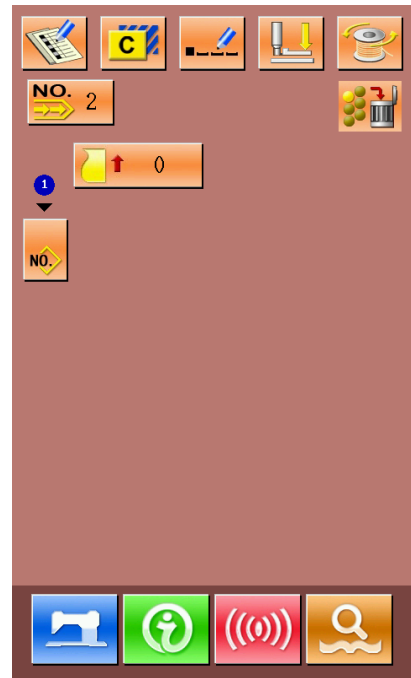
A、在此界面下，可有两种方法选择花样：

- 按下  可输入花样号选择花样
- 直接按花样号键选择

B、按下  可消除当前选中的花样。

C、按下  取消选择操作。

D、选择合适的花样，按下  确定选择，

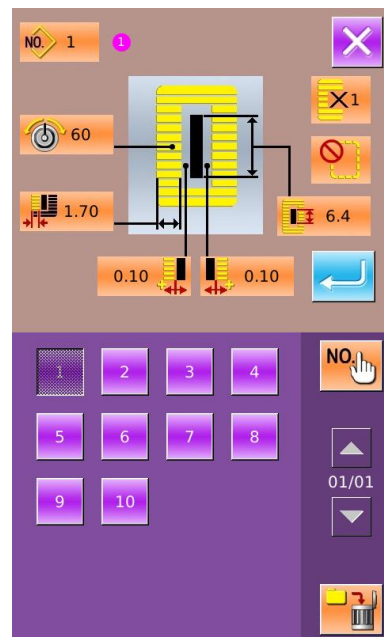

### ③ 缝制数据更改

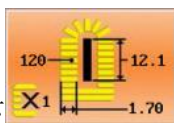

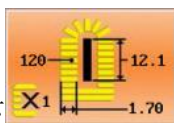
按下  进入缝制数据设置界面（如右图 2 所示）。



图 1





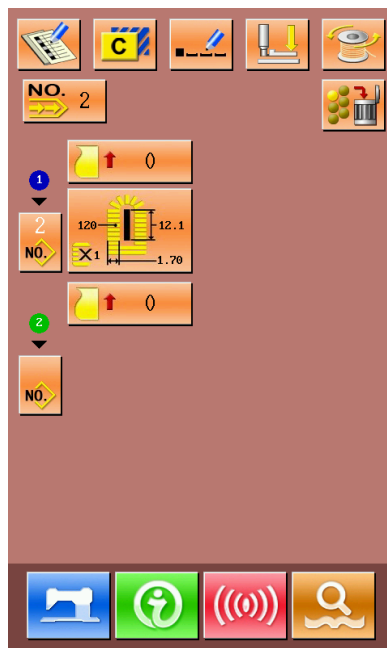

图 2

## 5.2.3 连续缝花样登记

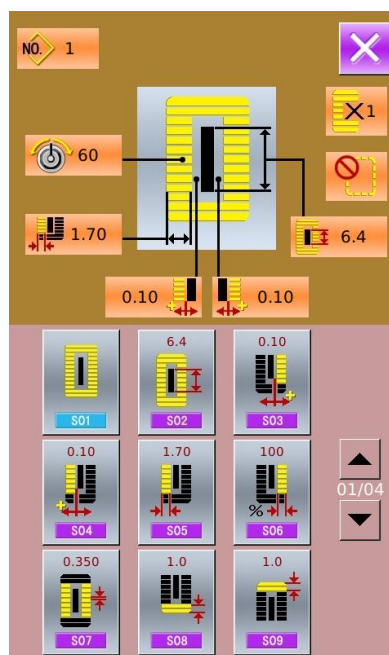
最大可登记 50 个连续缝花样，按下  进入连续缝花样登记界面（如右图所示）：

① 输入花样号

通过数字键可以选择想要输入的花样号码，已经登记的花样号码不能重复登记。通过 ， 键可以检索未登记的花样号码。

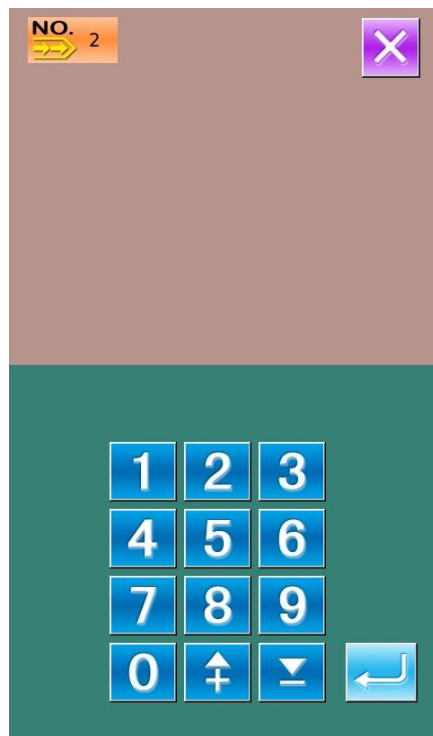

② 连续缝编辑

确定花样号码后按下 ，则进入连续缝编辑界面（如右图所示）。后续的操作参考“5.2.2”节

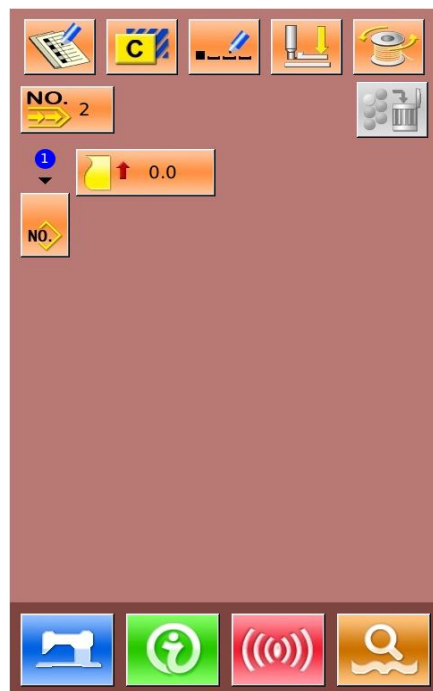



## 5.2.4 连续缝花样复制

### ① 选择被复制花样

按下  进入花样复制界面（如右图所示）。  
在已登记的花样中选择被复制花样号码并按下



按  和  可以查看连续缝中包含的花样形状。

按下  取消复制操作。

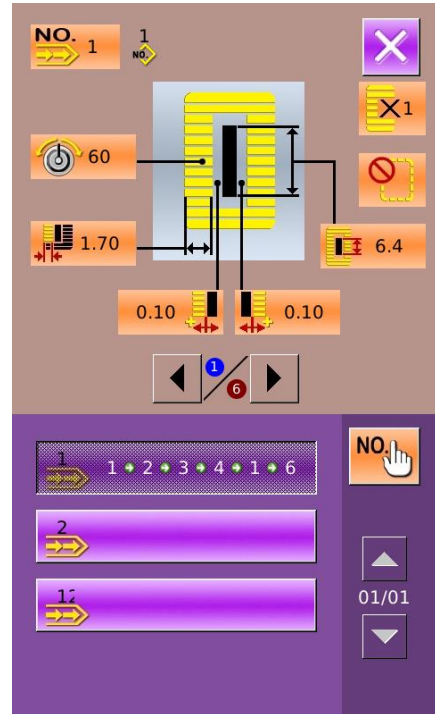

### ② 输入新登记的花样号码

界面上方显示为被复制花样缝制形状和相关缝制数据，通过数字键选择未登记的花样号码。

按下  则完成花样复制操作。

按下  取消操作，并返回上一界面。

※ 已经登记的花样号码不能重复登记

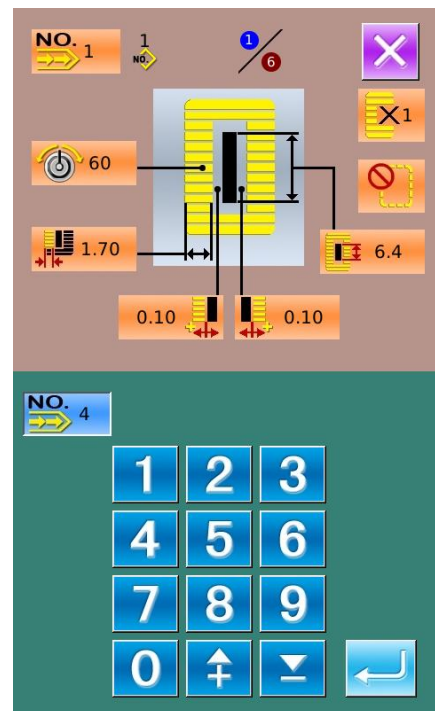

## 5.2.5 连续缝花样的删除

① 选择要删除的花样

按下  选择花样，按  后返回主界面，如右图所示

按下  进行连续缝花样的删除

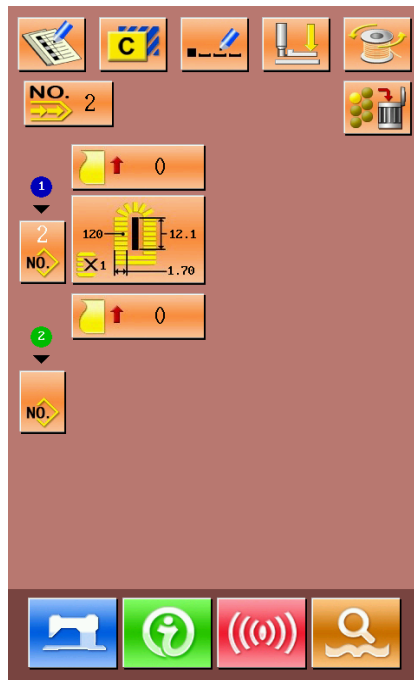

② 确认是否删除

按下  完成花样删除操作。

按下  取消删除操作。

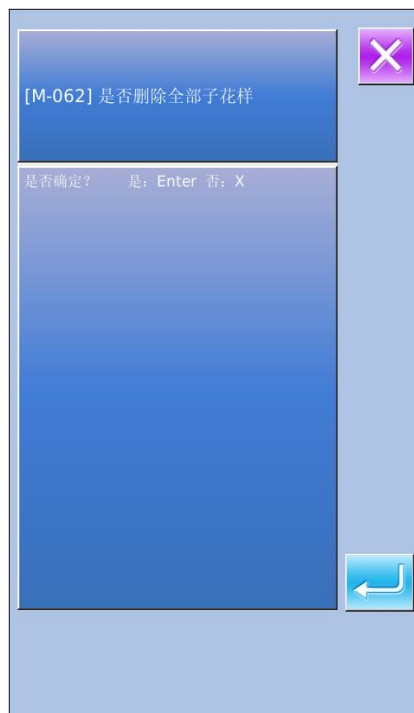



③ 完成删除

连续缝花样删除后，返回连续缝主界面，可以进行花样的重新编辑

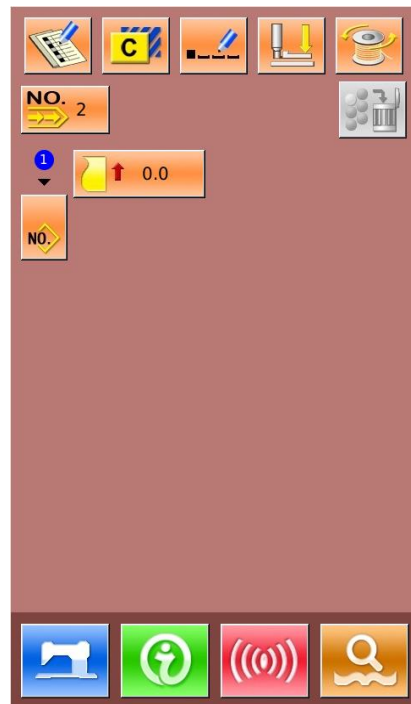

5.3 连续缝制界面

按下  进入缝制界面（如右图所示）。

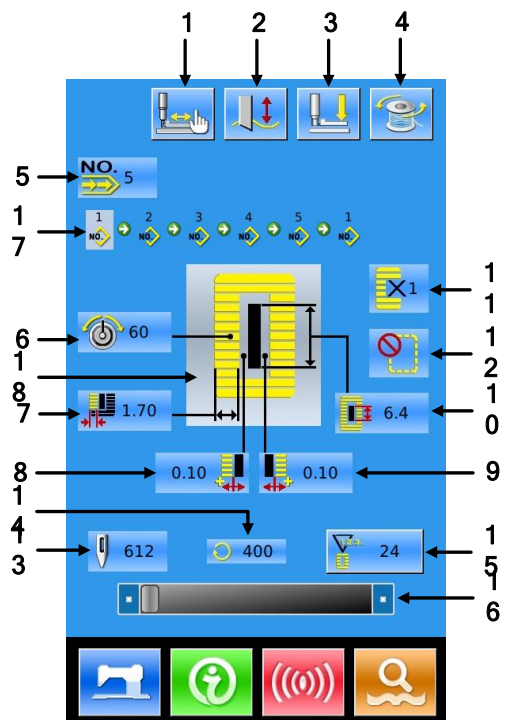

## 5.3.1 功能说明

序号	图标	功能	备注
1		试缝	
2		切刀使能	切换切刀使能
3		穿线（压脚下降）	
4		绕线	
5		花样号码显示	
6		上张力设定	
7		左包边宽度显示	
8		切刀槽左宽度显示	
9		切刀槽右宽度显示	
10		切布长度显示	
11		单次缝/双重缝显示	
12		下缝次数显示	
13		针数显示	
14		当前缝制速度显示	
15		计数器值显示  ：缝制计数器  ：计件计数器	
16		速度设置	
17		连续缝数据中输入的花样号码	
18		缝制形状显示	

### 5.3.2 连续缝试缝

#### (1) 显示缝制界面

在数据输入界面，按准备键之后，液晶显示的背景颜色变为蓝色，此时进入缝制界面。

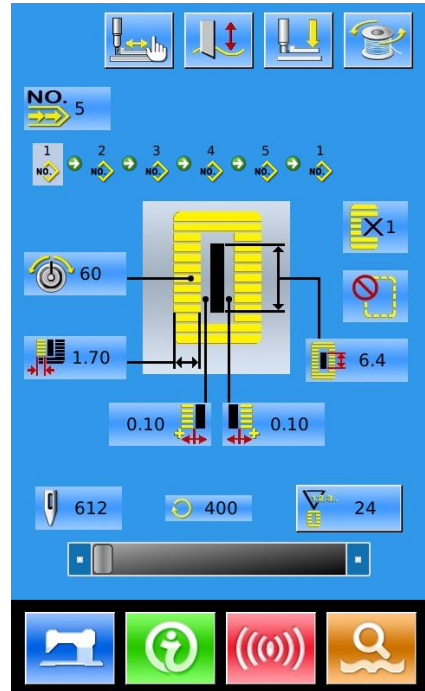



#### (2) 显示试缝界面

在缝制界面下，按下键后进入试缝界面（如右图所示）：

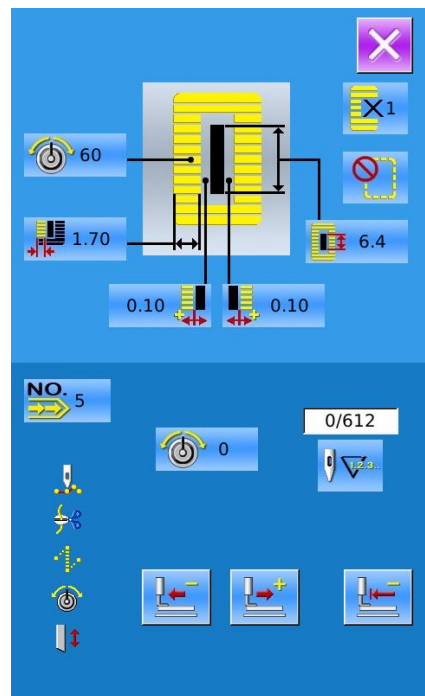
- ：返回原点
- ：后退
- ：前进
- ：落针点张力
- ：当前针数/总针数
- ：缝制指令
- ：切线指令
- ：空送指令
- ：线张力指令
- ：切刀驱动指令



### (3) 开始试缝

通过  返回原点键、 后退键和  前进键三个键开始试缝。此模式时，脚踩脚踏板开关，缝纫机起动缝完剩余的针数。

### (4) 结束试缝

按了取消键  退出试缝界面之后，返回缝制界面。

该功能用于循环顺序地缝制多个花样数据。一个循环缝花样最多可以输入 30 种图案，最多可以登记 50 个循环花样。

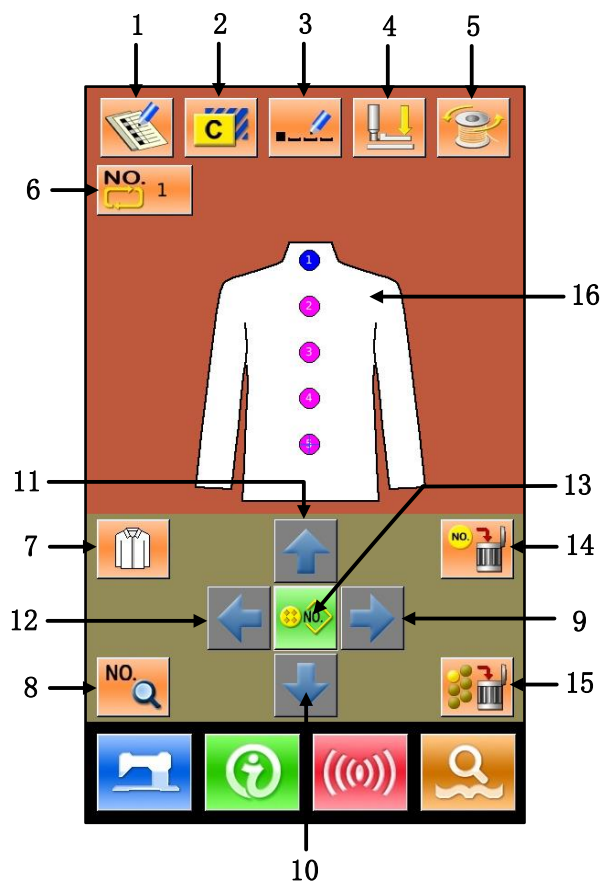



## 6 循环缝花样缝制

### 6.1 功能说明

序号	图标	功能	备注
1		新花样登记	
2		花样复制	
3		花样命名	
4		穿线	
5		绕线	
6		循环缝花样选择	
7		缝制衣物选择	
8		缝制数据修改	
9~12		光标移动键	
13		花样选择键	
14		子花样消除键	可以消除光标选择位置的子花样
15		全部子花样消除键	可以消除当前循环缝制数据里输入的全部子花样
16		缝制顺序	

### 6.2 循环缝编辑

#### 6.2.1 花样登记

通过数字键盘输入花样号码。

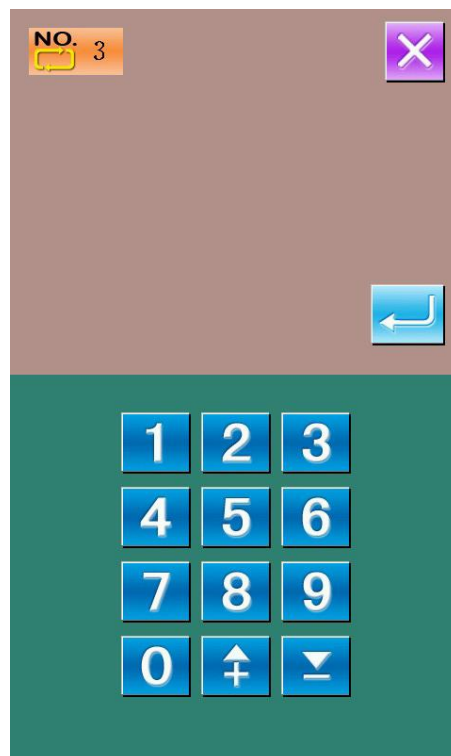

按下  键结束选择。

按下  键退出选择。



## 6.2.2 花样复制

### ① 选择被复制花样

按下  进入花样复制界面（如右图所示）。在已登记的花样中选择被复制花样号码并按下 。

按下  退出复制操作。

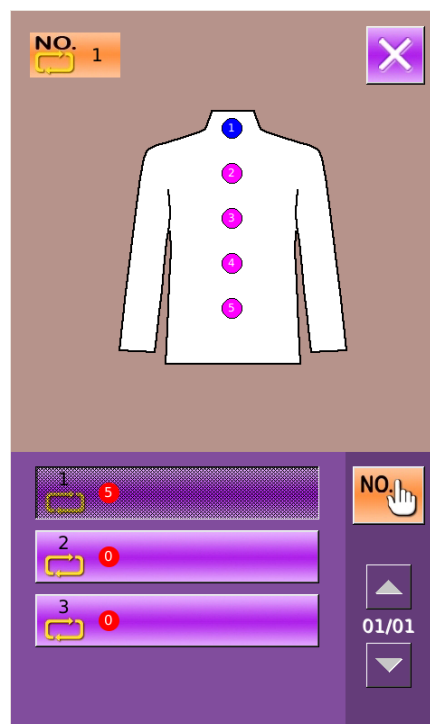



### ② 输入新登记的花样号码

界面上方显示为被复制花样,通过数字键选择未登记的花样号码,已经登记的花样号码不能重复登记。

按下  则完成花样复制操作。

按下  退出号码输入。

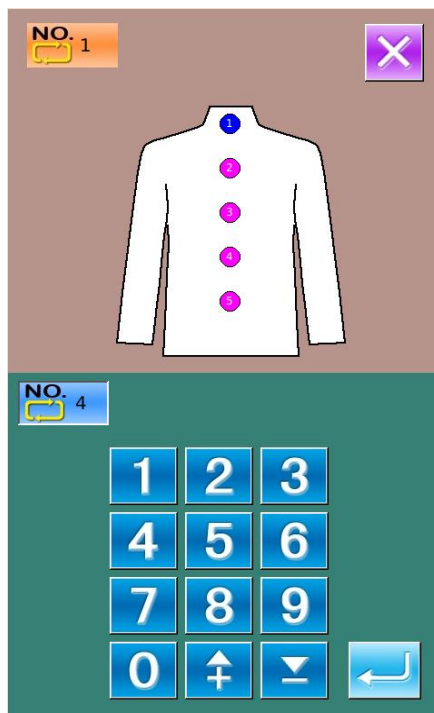

### 6.2.3 循环缝花样选择

按下  进入循环缝花样选择界面 (如右图所示)。

操作同普通花样选择。

按下  退出花样选择。

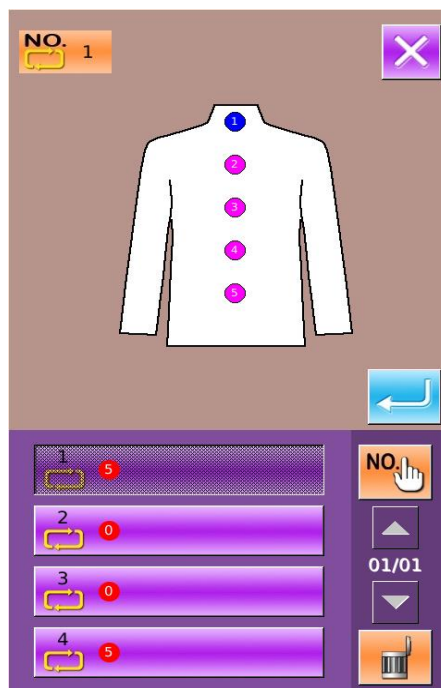

### 6.2.4 循环缝花样编辑

#### ① 开始编辑

通过方向 , , ,  选择希望的位置,

按下  进入花样选择界面 (如右图所示)。





#### ② 花样选择

: 输入号码查询花样

: 花样删除

: 切换到连续缝花样选择

选择合适的花样, 按下  结束选择。

按下  不选择直接退出。

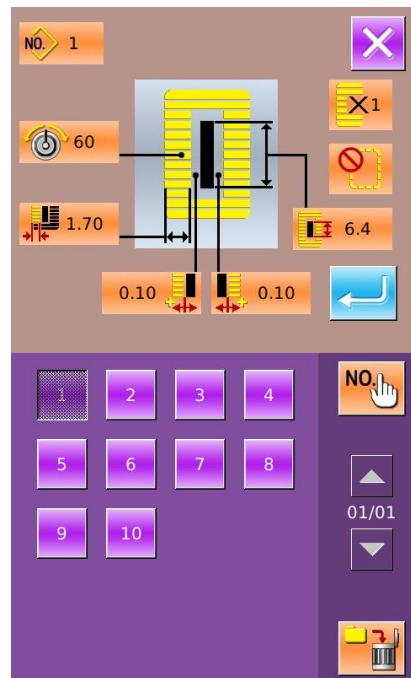

#### ③ 缝制数据变更

移动光标到想要修改的花样位置上, 按下  进入缝制数据设置界面 (如下图所示)。

按下  键退出相应的缝制数据变更界面

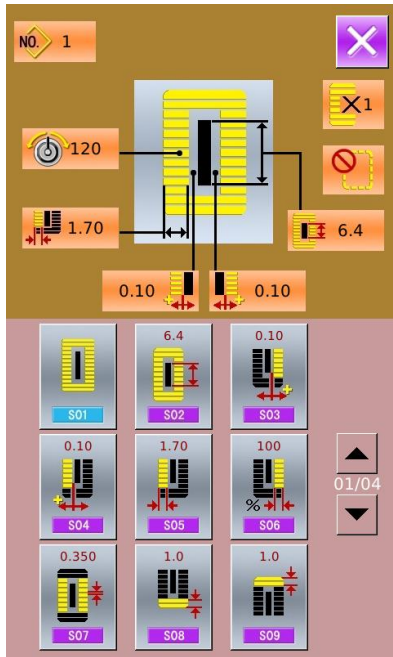

左图为普通花样缝制数据修改，具体操作参照 4.10 节缝制数据设置。

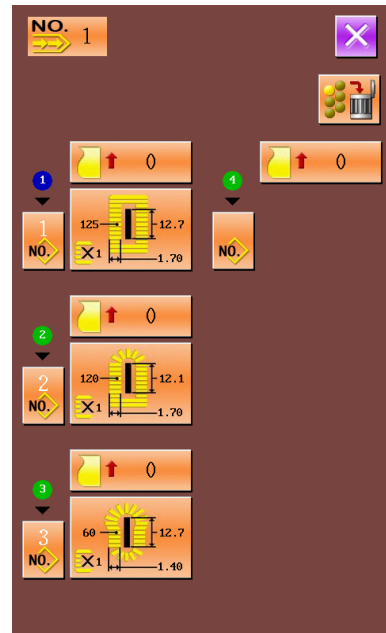



右图为连续缝花样缝制数据编辑，具体操作参照连续缝制数据输入。

### 6.2.5 变更缝制衣物

按下  可以进入缝制衣物选择界面（如右图所示），用于改变缝制数据输入界面的参照图。

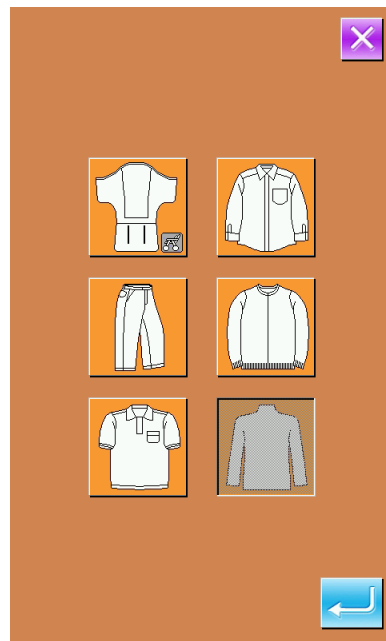
按  键退出，按  选择生效。





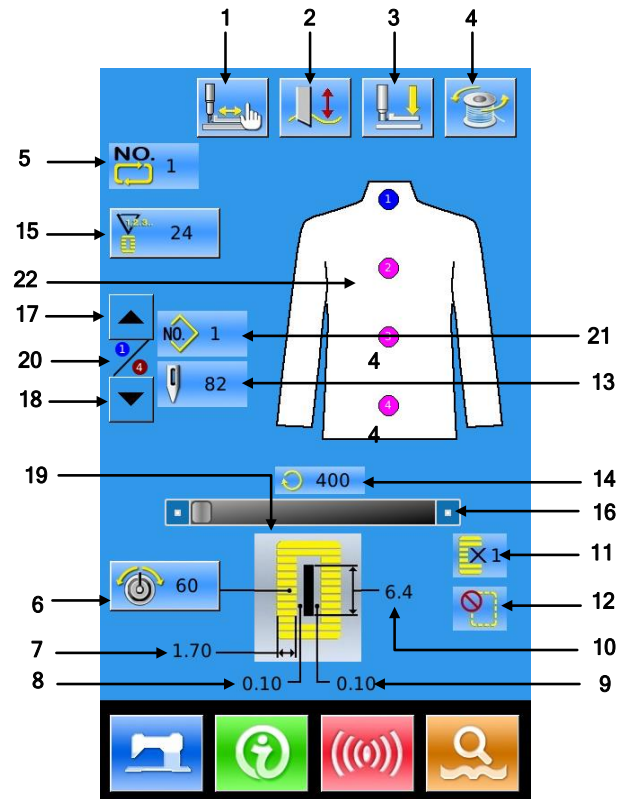





按下  进入缝制界面（如右图所示）。



### 6.3 循环缝制界面

#### 6.3.1 功能说明

序号	图标	功能	备注
1		试缝	
2		切刀使能	切换切刀使能
3		穿线（压脚下降）	
4		绕线	
5		花样号码显示	
6		上张力设定	
7		左包边宽度显示	
8		切刀槽左宽度显示	

序号	图标	功能	备注
9		切刀槽右宽度显示	
10		切布长度显示	
11		单次缝/双重缝显示	
12		下缝次数显示	
13		针数显示	
14		当前缝制速度显示	
15		计数器值显示  : 缝制计数器  : 计件计数器	
16		速度设置	
17		缝制顺序减操作	倒回前一个缝制的缝制顺序
18		缝制顺序加操作	进入下一个缝制的缝制顺序
19		缝制形状显示	
20		缝制中的缝制顺序	
21		当前缝制的序列花样号	
22		缝制顺序	

## 6.3.2 循环缝试缝

### (1) 显示缝制界面

在数据输入界面，按准备键之后，液晶显示的背景颜色变为蓝色，此时进入缝制界面。

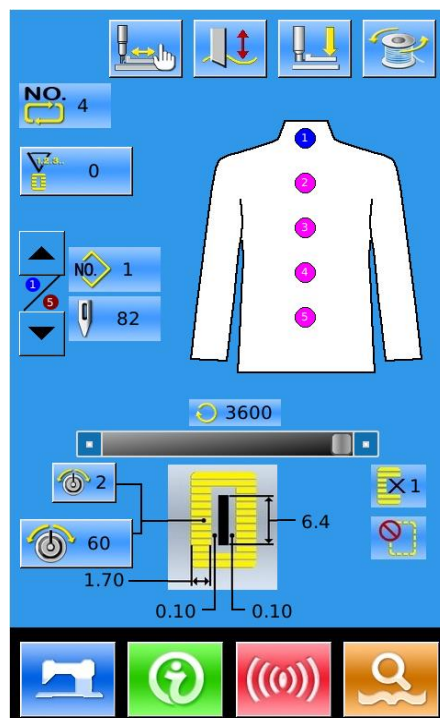

(2) 显示试缝界面

在缝制界面下，按下  键后进入试缝界面（如右图所示）：

：返回原点

：后退

：前进

：落针点张力

：当前针数/总针数

：缝制指令

：切线指令



：空送指令

：线张力指令

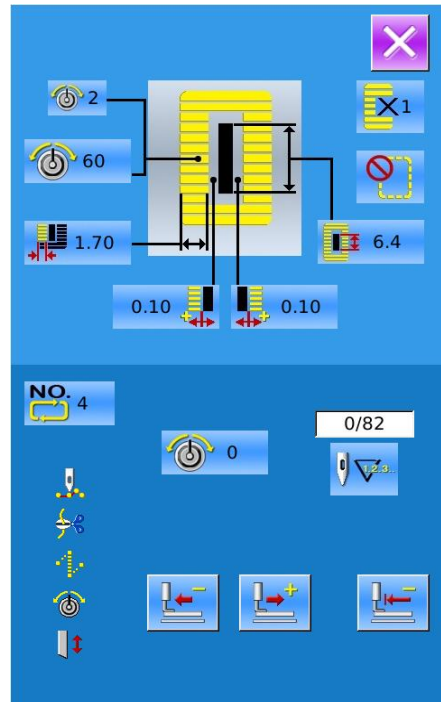
：切刀驱动指令



### (3) 开始试缝

通过  返回原点键、 后退键和  前进键三个键开始试缝。此模式时，脚踩脚踏板开关，缝纫机起动缝完剩余的针数。

### (4) 结束试缝

按了取消键  退出试缝界面之后，返回缝制界面。



# 7 模式设置

按下  可以切换数据输入界面和模式界面（如右图所示），在该界面下可以进行一些详细的设置和编辑操作。

注：部分图标需要长按  键打开。

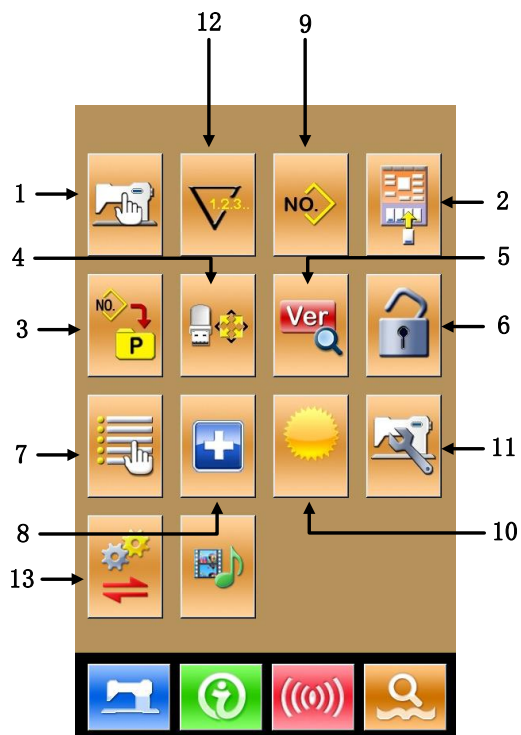



## 7.1 功能说明

序号	图标	功能	备注
1		一级参数设置	
2		缝制数据编辑	
3		P 花样设置	
4		格式化	
5		软件版本查询	
6		锁键盘	
7		用户管理项设置	
8		检测模式	
9		缝制类型设置	
10		亮度调节	
11		二级参数设置	
12		计数器设置	
13		参数备份还原	

## 7.2 一级参数设置

### ① 参数设置操作

选择  进入一级参数设置界面（如右图所示）。

按  键退出参数设置界面。

当有参数修改时，在参数设置界面显示【已修改】  
按键，

选择想要修改的参数后进入设置状态，参数设置分为数据输入类型和选择类型。举例如下：



选择 U01，进入界面



选择 U19，进入界面

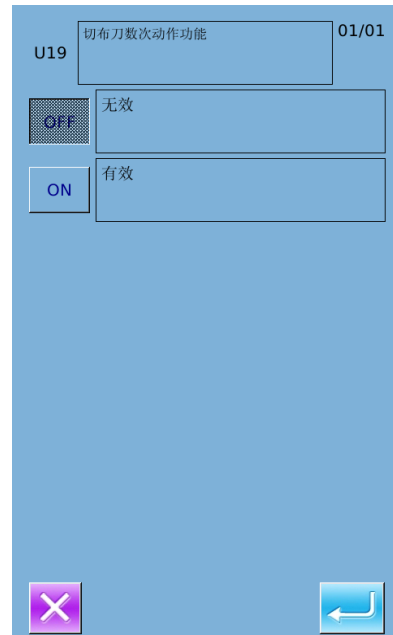

## ② 参数加密

A、按“加密”键后，进入密码输入界面。

按  全部清除输入内容

按  每按一次删除一个字符

B、输入正确的密码后，进入参数加密界面  
选择要加密的参数

按【全选】，全部参数加密

按【反选】，反向选择参数加密

按【改密】，修改加密密码，默认是厂家 ID

按退出键  退出加密功能

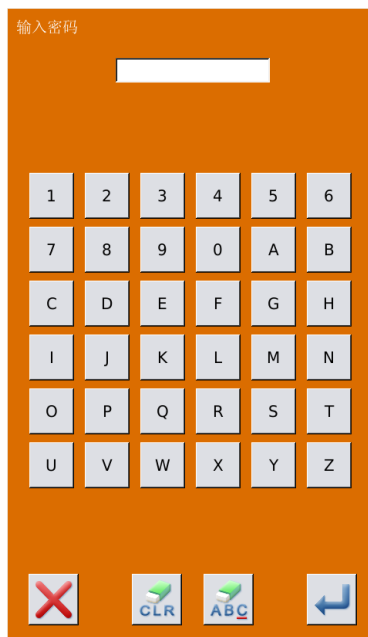

## ③ 查询已修改参数

A、当有参数修改时，在参数设置界面显示【已修改】按键

B、在参数设置界面，按下【已修改】按键，可以查询已修改过的参数。

首先要求输入密码，输入密码界面的操作参考②的 A 项，输入正确的密码后进入到已修改参数查询界面

C、在已修改参数查询界面下，可以查询到所有修改过的参数列表，在该列表中显示修改的当前值和复位值。

在该界面下：

- 按【还原所有】按键，将修改的参数恢复为复位值
- 点按参数名称键，例如【压脚类型】，再点按【选择还原】将选中的参数恢复为复位值。参数键可以多选。
- 按参数号码键，例如【U14】，能够进入参数设置界面，可以重新设置参数数值。
- 存在多于 1 个页面时，通过箭头按键可以翻页操作。
- 点按，退出该界面

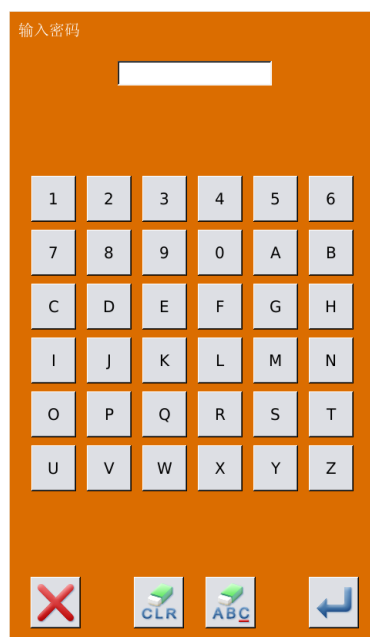

## 一级参数表

序号	项目	设定范围	编辑单位	出厂设置
U01	压脚提升最高位置 设定踏板动作的最高位置高度。	0~17.0	0.1mm	14.mm
U02	压脚提升中间位置 设定踏板动作的中间位置高度。	0~14.0	0.1mm	6.0mm
U03	压脚提升布安放位置 设定踏板动作的布安放位置高度。	0~14.0	0.1mm	0
U04	双踏板的踩踏位置 设定双踏板时的操作。	5~95	1%	80%

序号	项目	设定范围	编辑单位	出厂设置
U05	双踏板的压脚提升位置 设定双踏板时的操作。  	5~95	1%	50%
U06	缝制结束上线张力设定	0~200	1	35
U07	切线时的上线张力设定	0~200	1	35
U08	设定调整下缝的上线张力设定	0~200	1	60
U09	设定软起动速度 (第 1 针)	400~4200	100rpm	800rpm
U10	设定软起动速度 (第 2 针)	400~4200	100rpm	800rpm
U11	设定软起动速度 (第 3 针)	400~4200	100rpm	2000rpm
U12	设定软起动速度 (第 4 针)	400~4200	100rpm	3000rpm
U13	设定软起动速度 (第 5 针)	400~4200	100rpm	3600rpm
U14	压脚类型 (1, 2, 3, 5 号类型) 1 型: 25 x 4    2 型: 35 x 5 3 型: 41 x 5    5 型: 自定义	1, 2, 3, 5		1 型
U15	压脚宽度 (5 型) U14 设定为 5 型之后, 该参数被打开。	3.0~10.0	0.1mm	3.0mm
U16	压脚长度 (5 型) U14 设定为 5 型之后, 该参数被打开。	10.0~120.0	0.5mm	10.0mm
U17	缝制开始位置 (送布方向) 设定对于压脚的缝制开始位置。由于有高有低, 想移动开始位置时进行设定。	2.5~110.0	0.1mm	2.5mm
U18	切布刀尺寸	3.0~32.0	0.1mm	32.0mm
U19	切布刀数次动作功能	ON、OFF		ON
U20	断线检测功能	ON、OFF		ON
U21	选择准备键 ON 时压脚位置 设定按了准备键后压脚的位置 UP: 上升 DN: 下降	UP、DN		UP
U22	选择缝制结束时的压脚位置 设定结束后的压脚位置。 (仅单踏板时有效) UP: 上升 DN: 下降	UP、DN		UP
U23	上线切线打开动作开始距离 输入开始缝制之后上线切线马达开始开放剪刀动作的距离。	0~15.0	0.1mm	1.8mm
U24	底线切线打开动作开始距离 设定缝制开始之后到底线切线马达开始开放剪	0~15.0	0.1mm	1.5mm

序号	项目	设定范围	编辑单位	出厂设置
	刀动作的距离。			
U25	计数器更新单位 设定更新缝制计数器的单位。	1~30	1	1
U26	禁止计数器被修改	ON、 OFF		OFF
U27	计数器到达设定值时缝纫机的操作	ON 、OFF		OFF
U49	照明灯亮度调节	0-5	1	0
U50	蜂鸣器声音设定 OFF: 禁止蜂鸣器 PAN: 操作盘声音 ALL: 操作盘加报警	OFF、 PAN、 ALL		ALL
U100	背光自动关闭 OFF: 不自动关闭 ON: 自动关闭	ON、 OFF		OFF
U101	背光自动关闭等待时间	1~9	1	3s
U102	音量大小	30-63	1	50
U200	语言选择	中文、英文、 土耳其文		中文
U201	开机是否进入语言选择	ON、 OFF		OFF

## 7.3 二级参数设置

### ① 参数设置操作

在设置模式等级 3 下，选择  进入二级参数设置界面（如右图所示）。操作方法参照“7.2 一级参数设置”。

当有参数修改时，在参数设置界面显示【已修改】按键，

按  键退出参数设置界面

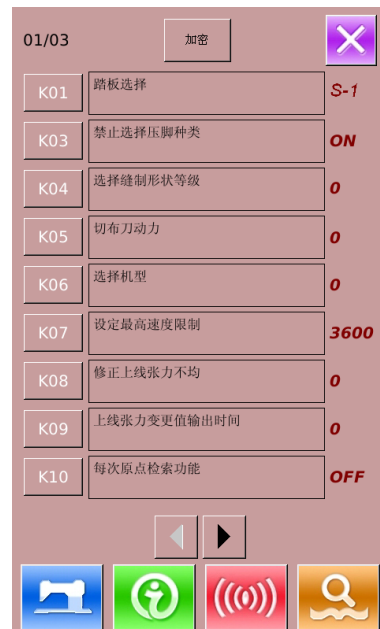

### ② 参数加密

参数加密的操作步骤，请参考“7.2 一级参数设置”

按键退出参数加密界面



### ③ 已修改参数查询

当有参数修改时，在参数设置界面显示【已修改】按键，

点按【已修改】按键可以查询已修改过的参数，并且可以进行参数的复位。

具体操作可参考“7.2 一级参数设置”

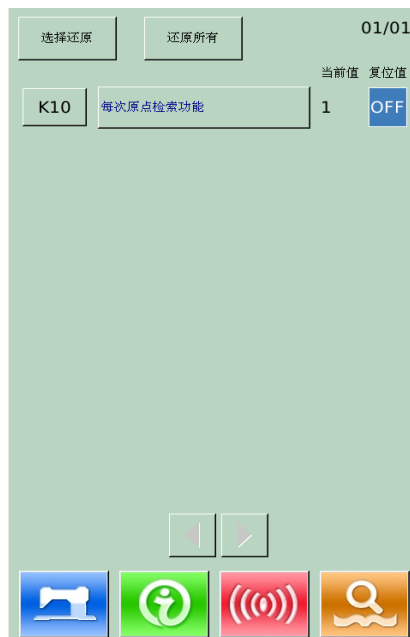

### 二级参数表

序号	项目	设定范围	编辑单位	出厂设置
K01	选择踏板 D: 双踏板 S-1: 单踏板（无中间位置） S-2: 单踏板（有中间位置） S-3: 模拟单踏板（无中间位置） S-4: 模拟单踏板（有中间位置） S-5: 模拟单踏板（有返回踩踏）	D、 S-1、 S-2 S-3 S-4 S-5		S-3
K03	禁止选择压脚种类 OFF: 禁止变更	ON、OFF		ON



序号	项目	设定范围	编辑单位	出厂设置
	ON: 允许变更			
K04	选择缝制形状等级 (12/20/30)	0~2		0
K05	切布刀动力 设定切刀的输出动力。	0~3	1	0
K06	选择机种 (0-标准型, 1-干式)	0~1	1	0
K07	设定最高速度限制 K06 为干式时, 最高速度自动限制在 3300rpm。 ※ 受密码保护	400~4200	100rpm	3600rpm
K08	修正上线张力不均 修正全体平衡的上线张力的输出值。	-30~30	1	0
K09	上线张力变更值输出时间 变更了上线张力有关数据后, 仅在设定时间输出其变更值。	0~20	1s	0
K10	每次原点检索功能 缝制结束后进行原点检索。 OFF: 无 1: 缝制结束后 2: 循环缝结束后	OFF、1、2		OFF
K11	逆转提升机针 U01 压脚提升最高为止设定为 14.0mm 以上后, 自动地逆转提升机针, 停止缝纫机。 其动作可以设定为禁止。 OFF: 禁止逆转提升 ON: 允许逆转提升	ON、OFF		ON
K12	设定切刀继电器下降时间	25~100	5ms	35
K13	设定切刀继电器上升时间	5~100	5ms	15
K14	切刀筒下降时间 (选购)	5~300	5ms	50
K15	Y 送步马达 原点修正	-120~400	1 脉冲 (0.025mm)	0
K16	机针摆动马达 原点修正	-10~10	1 脉冲 (0.05mm)	0
K17	压脚提升马达 原点修正	-100~10	1 脉冲 (0.05mm)	0
K18	直接选择按键显示 OFF: 不显示 ON: 显示	ON、OFF		OFF
K19	连续缝制中途切线 禁止时, 空送设为无效, 登记的花样被缝制到相同位置, 变为重叠缝制。 OFF: 禁止 ON: 允许	ON、OFF		ON

序号	项目	设定范围	编辑单位	出厂设置
K20	返回切刀的动力变更 设定返回布切刀时的输出动力。	0~3	1	0
K21	切底线马达缝制开始时的开放量设定缝制 开始时切底线剪刀的开放量。	1~15	1 脉冲	8
K22	压脚提升速度的选择	1~3	1	1
K25	切刀原点微调	-100-100	1	0
K28	传送速度设置	1-5	1	1
K29	面线剪线速度选择	0-1	1	1
K150	安全开关	0-1	0	1
K189	断线检测灵敏度调整	1~10	1	3
K200	恢复出厂参数 ※ 受密码保护			
K201	主控烧录地址	主控烧录地址 0xA0000:655360 0xB0000:720896 0xC0000:786432 0xD0000:851968 0xE0000:917504	655360-917504	1
K202	机型设置	0: 1790 1:1796	0-1	0

## 7.4 计数器设置



按下  进入计数器设置界面（如右图所示）。

操作步骤：

### ① 缝制计数器类型选择

选择缝制计数、件件计数功能

### ② 设定当前值、设定值

在选定的类型中按“当前值”、“设定值”按键，进行有关操作

### ③ 选择加计数还是减计数

在选定的类型中，按“加”、“减”按键，进行有关操作。

按  键退出计数器设置界面。

按  完成设置，并退出。

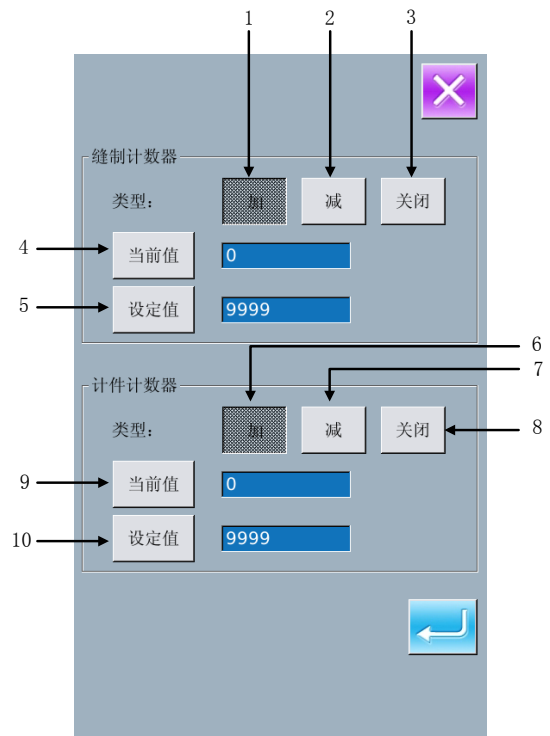

**缝制加计数:**

每缝制 1 形状的缝制物之后, 在当前值上加数。当当前值与设定值相等时, 显示出计数器溢出报警界面。

按下  键, 计数器当前值恢复为 0。

**缝制减计数:**

每缝制 1 形状的缝制物之后, 从当前值减 1。当当前值等于 0 之后, 显示出计数器溢出报警界面。

按下  键, 计数器当前值恢复为设定值。

**计件加计数:**

每缝制 1 循环或 1 连续缝, 在当前值上进行加数。当当前值与设定值相等时, 显示出计数器溢出报警

界面。按下  键, 计数器当前值恢复为 0。

**计件减计数:**

每缝制 1 循环或 1 连续缝, 从当前值减 1。当当前值

等于 0 之后, 显示出计数器溢出报警界面。按下  键, 计数器当前值恢复为设定值。

**④ 关闭计数器**

在选定的类型中, 按“关闭”按键, 关闭计数器。

## 7.4.1 功能介绍

序号	功能	备注
1	缝制计数器加计数	
2	缝制计数器减计数	
3	关闭缝制计数器	
4	设定缝制计数器当前值	
5	设定缝制计数器设定值	
6	计件计数器加计数	
7	计件计数器减计数	
8	关闭计件计数器	

9	设定计件计数器当前值	
10	设定计件计数器设定值	

## 7.5 用户管理项设置

可以把经常使用的缝制数据登记到管理按键使用。

按下  进入用户管理项设置界面(如右图所示)。

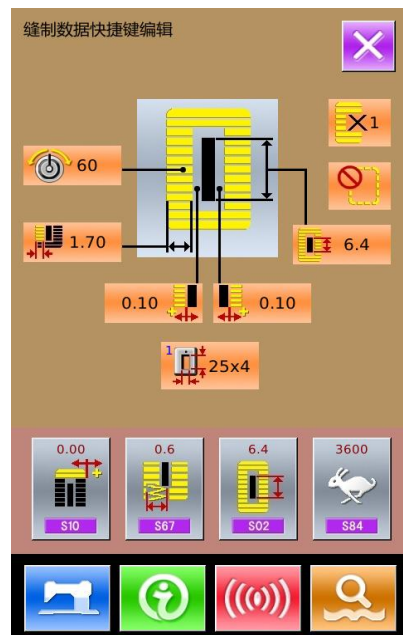

### ① 登记管理按键

管理按键最多可以登记4个，在当前界面上显示了4个管理登记按键，按下想登记的位置的按键之后，缝制数据选择界面被显示出来(如右图所示)。

按下  键退出用户管理项设置界面

选择想要登记的缝制数据，按下  结束登记操作。新登记的缝制数据会显示在用户管理按键上。

### ② 出厂登记状态

出厂时从左到右按照顺序被登记：



S07：平行部间距；

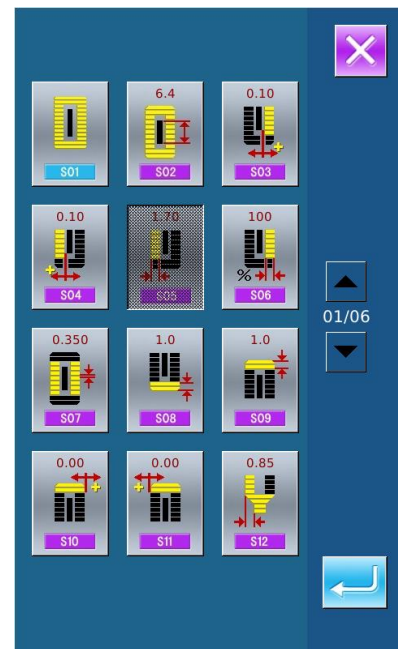



S11: 修正左加固宽度



S10: 修正右加固宽度;



S57: 缝制开始上线张力设定

## 7.6 缝制数据编辑

部分缝制数据是可以设定是否被打开的，在设置模

式等级 2 下，按下  进入缝制数据编辑界面（如右图所示）。





S20: 缝制数据打开



S20: 缝制数据关闭

选择想要编辑的缝制数据，按键之后，可以变换翻转打开/关闭显示界面。

按下  之后，可以确定设定的缝制数据项目是否打开的状态。

按  键退出缝制数据编辑界面

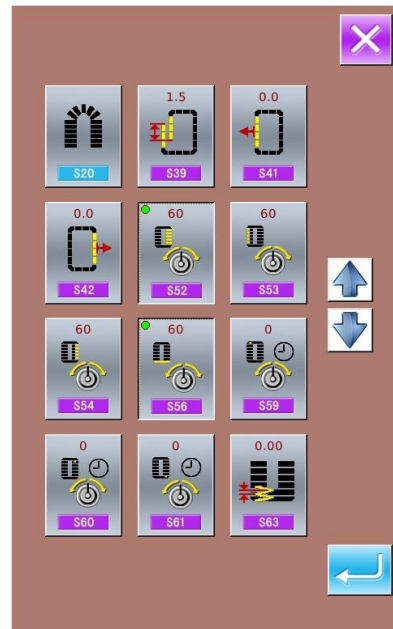

## 7.7 变换缝制类型



按下  进入缝制类型选择界面（如右图所示）。



: 普通缝



: 连续缝



: 循环缝

确定缝制类型之后，按下  结束。按  之后，显示出选择的缝制类型的数据输入界面。

按  键退出变换缝制类型界面，原来的缝制类型不变。



## 7.8 登记花样到直接按键上

可以把经常使用的花样号登记到直接按键上进行使用。

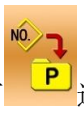

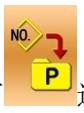
按下  进入到直接按键登记界面（如右图所示）。

按  键退出花样登记功能

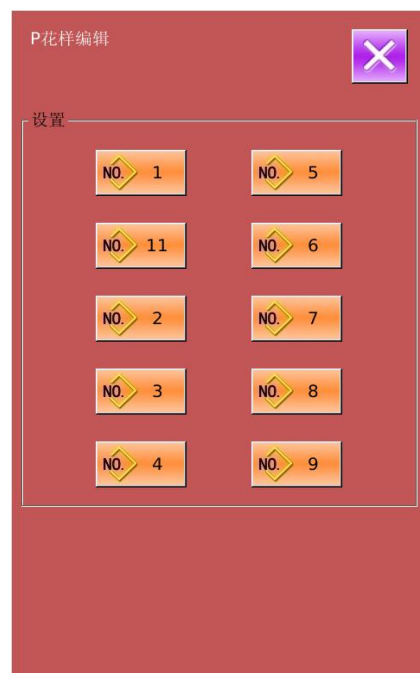

最多可以登记 10 个花样，在显示的 10 个直接按键上，选择想登记位置的按键之后，进入花样选择界面（如右图所示）。

蓝色标示的文件是 vdt 格式文件。

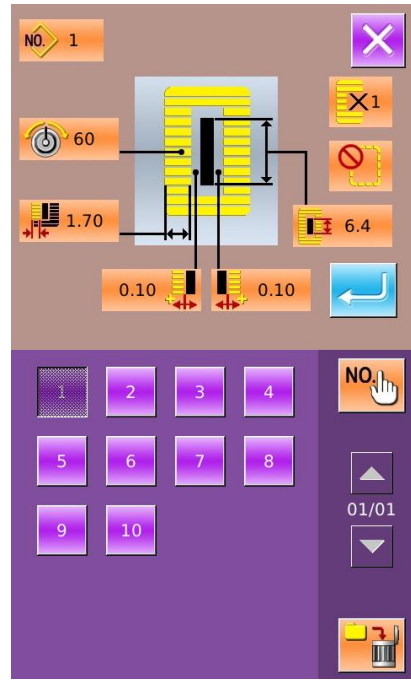

: 花样查询

: 消除当前登记花样

: 确定选择

: 退出

## 7.9 检测模式

在设置模式等级 2 下，按下  键可以进入检测模式界面（如右图所示）。

各图标功能说明详见下表：

序号	名称
A	I01 上剪线
B	I02 下剪线
C	I03 输入检测
D	I04 液晶显示检测
E	I05 触摸屏校正
F	I06 输出检测
G	I07 转速测定
H	I08 连续运转

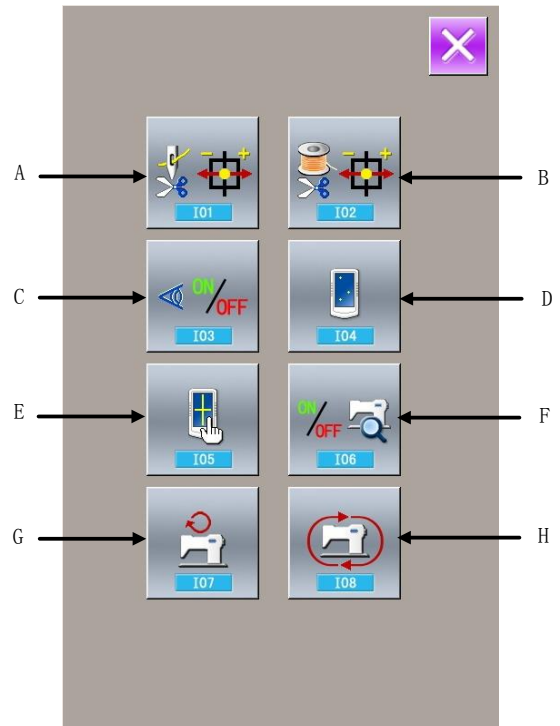

按  键退出检测模式界面

### (1) 上剪线的调整方法

#### ① 上剪线调整方法



在检测模式界面按下  (I01 上剪线) 键进入上剪线的调整界面 (如右图所示):

上剪线:

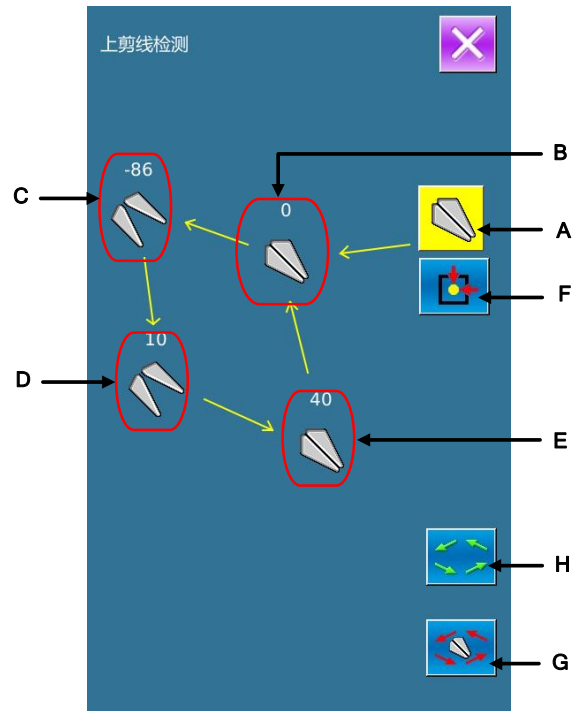
序号	名称	范围	初始值
A	原点位置		
B	起始位置	-10~10	0
C	张口位置	-95~-80	-86
D	待剪位置	0~20	10
E	剪后位置	30~50	40



#### ② 选择想要调整的模式位置

通过按  键选择所要调整的位置 (A、B、C、D), 然后通过按加减键调整所需的数值。然后按  F 键返回到原点位置,

#### ③ 按 键返回到检测模式界面。

### (2) 下剪线的调整方法

#### ① 下剪线调整方法



在检测模式界面按下  (I02 下剪线) 键进入下剪线的调整界面 (如右图所示):

下剪线:

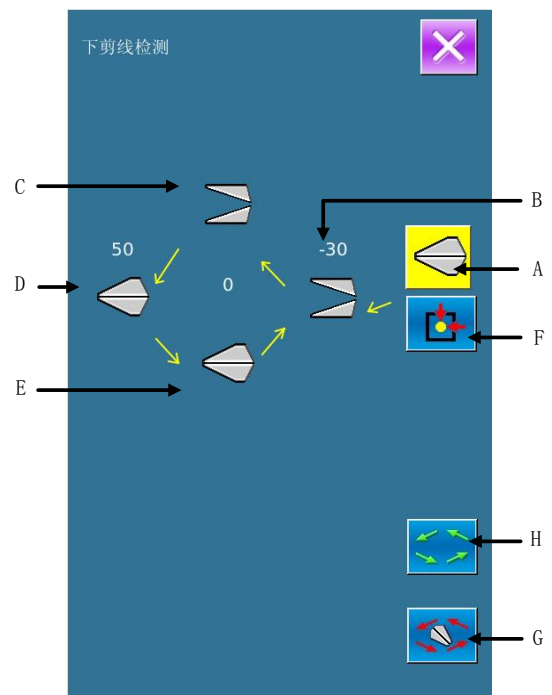
序号	名称	范围	初始值
A	原点位置		
B	张口位置	-40~-15	-30
C	待剪位置	-10~-10	0
D	剪后位置	40~60	50
E	起始位置	-10~-15	0



#### ② 选择想要调整的模式位置

通过按  键选择所要调整的位置 (A、B、C、D), 然后通过按加键  或减键  调整所需



的数值。然后按  F 键返回到原点位置。

按  键返回到检测模式界面。

### (3) 输入信号检测方法

在检测模式界面按下  (I03 输入检测) 键进入输入检测界面 (如右图所示), 在该界面下可以确认各种开关和传感器的输入状况。

**ON:** 表示开启

**OFF:** 表示关闭

A: 踏板量

B: 踏板传感器

C: 断线检测

D: 切刀传感器

E: 机头翻倒传感器

F: 停止开关

G: 摆针传感器

H: 缝纫机半月板传感器

I: Y 送布原点检测

J: 压脚原点检测

K: 剪面线电机原点检测

L: 剪底线电机原点检测



#### (4) 液晶检测



在检测模式界面按下  (I04 液晶检测) 键进入液晶检测界面 (如右图所示), 在该状态下检测液晶是否失色。

在界面下点按, 在“蓝色 — 黑色 — 红色 — 绿色 — 白色”间循环显示

按退出键  退出液晶检测界面。



#### (5) 触摸屏校正

A、在检测模式界面按下  (I05 触摸屏校正) 键, 提示【确定进入触摸屏校正模式】, 按  进入触摸屏校正界面 (如右图所示), 按  可以退出触摸屏校正状态。

B、需要进行 5 点校正, 最好采用触摸笔一类的工具点击画面中的十字光标, 校正结束后, 会显示本次操作是否成功

※ 校正过程中, 请务必按照十字光标标识的位置进行, 否则会导致校正结束后无法正常使用触摸屏的情况

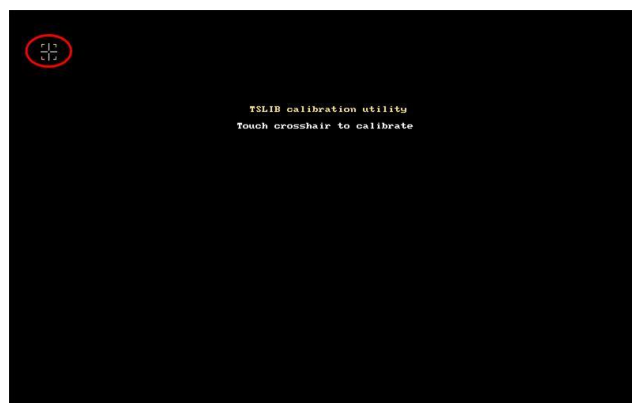

### (6) 输出检测方法





在检测模式界面按下 (I06 输出检测) 键进

入输出检测界面 (如右图所示),

在该界面下可以检测的输出状态包括:

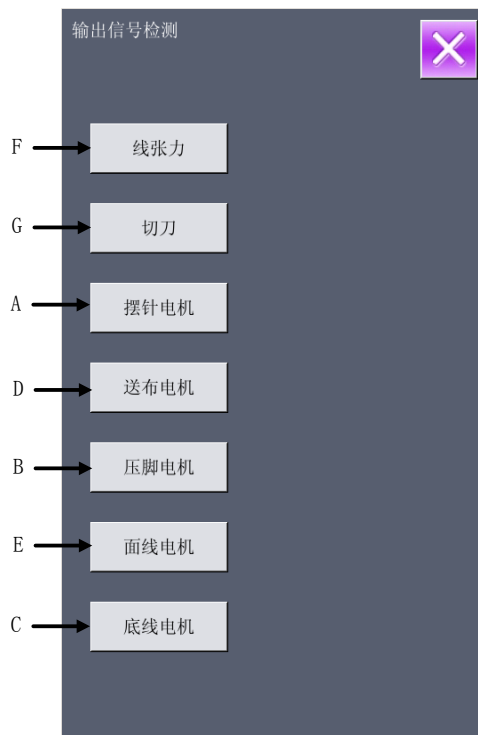
- A: 摆针电机检测
- B: 压脚电机检测
- C: 底线剪线电机检测
- D: 送布电机检测
- E: 面线电机检测
- F: 线张力电磁铁
- G: 切刀电磁铁



- 点按 A~E 时, 会出现  提示条, 点按【+】、【-】键, 提示框中显示设定的电机的原点检测状态。
- 点按 F~G 时, 相应的电磁铁会有动作。
- 按  退出输出检测界面

※ 注意缝纫机会有相应的动作

### (7) 转速测定

#### ① 显示转速测定界面



在检测模式界面按下 (I07 转速测定) 键进

入转速测定界面 (如右图所示), 在该界面下可以检测主轴马达转速。

按退出键  退出转速测定界面。

#### ② 转速测定设置

通过按加键“+”和按减键“-”可以设置主轴马

达转速, 按下  后, 主轴马达会以已设定的转速旋转。此时, 实际测得的转速在界面中的实

际转速栏中显示。按下  则机器停止运转。

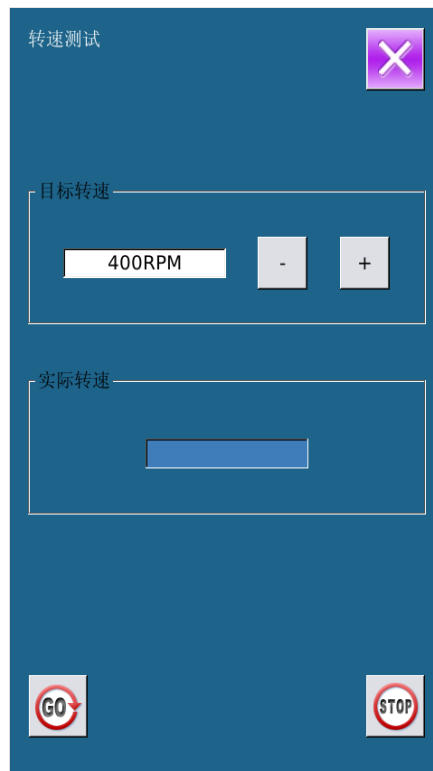

## (8) 连续运转

### ① 显示连续运转界面

在检测模式界面按下  (I08 连续运转) 键进入连续运转界面 (如右图所示)。

A: 动作间隔

B: 收针原点检测

按退出键  退出连续运转界面。



### ② 连续运转设置

点击连续运转状态下的“动作间隔”输入框和“收针原点检测”输入框, 通过数字键盘输入设置值, 可设定动作间隔时间和收针原点检测。

按  键, 踩下脚踏板即开始连续运转。连续运转过程中可以通过暂停开关暂停, 也可以在动作结束后压脚抬起时踩下脚踏板或按暂停开关停止连续运转。



## 7.10 亮度调节

在设置模式等级 2 下, 按下  可以进入亮度调节界面 (如右图所示), 分为 20~100 档。可以通过加键  或减键  调节所需的数值, 也可以通过数

字键盘输入数值然后按下  完成输入, 按退出键

 退出亮度调节界面。。



## 7.11 锁键盘操作

在设置模式等级 2 下，按下  进入锁键盘设置界面。

### ① 锁键盘操作



: 未设定锁键盘状态



: 已设定锁键盘状态

选择 ，按下  完成锁键盘操作。按退出键  退出锁键盘操作。

### ② 锁键盘状态显示

关闭参数设置模式界面，返回数据输入界面，如右图，可以看到花样号码下方有一个显示锁键盘状态的图标 。在锁键盘状态下仅显示可使用图标。

### ③ 锁键盘范围

1. 普通缝数据输入界面：

- 1) 花样登记
- 2) 花样复制
- 3) 花样命名
- 4) 用户管理
- 5) 压脚选择
- 6) 形状和相关缝制数据

2. 普通缝缝制界面：

- 1) 计数器设置
- 2) 上张力设置

3. 连续缝数据输入界面：

- 1) 花样登记
- 2) 花样复制
- 3) 花样命名
- 4) 送布量
- 5) 删除
- 6) 花样缝制数据

4. 连续缝缝制界面：

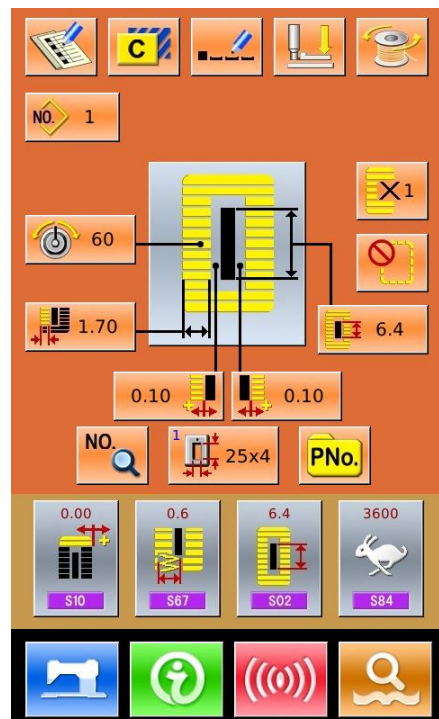
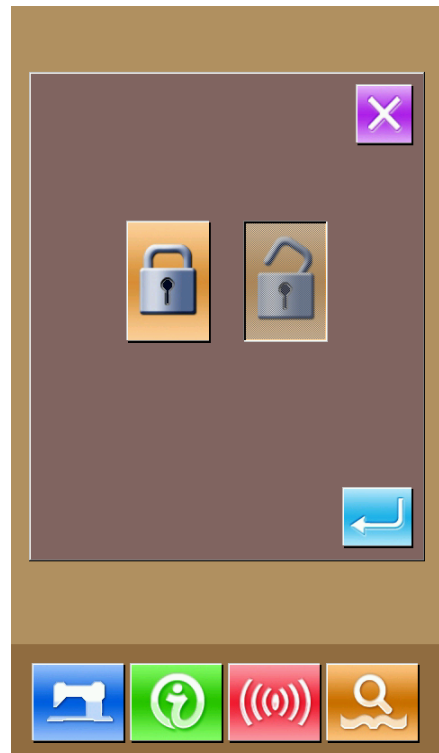

- 1) 计数器设置
- 2) 上张力设置
- 5.循环缝数据输入界面:
  - 1) 花样登记
  - 2) 花样复制
  - 3) 花样命名
  - 4) 删除
  - 5) 全部删除
  - 6) 缝制衣物
  - 7) 子花样登记
- 6.循环缝缝制界面:
  - 1) 计数器设置
  - 2) 上张力设置
- 7.参数设置模式:
  - 1) 参数 1 级
  - 2) 参数 2 级
  - 3) P 花样编辑
  - 4) 用户管理
  - 5) 缝制数据编辑
  - 6) 检测模式
  - 7) 计数器编辑

## 7.12 格式化操作



按下  进入锁键盘设置界面。

在该界面下，可以完成：

- U 盘格式化
- 内存花样格式化
- 自定义格式化

按下相应的功能键，进入相关界面。

按退出键  退出格式化 U 盘

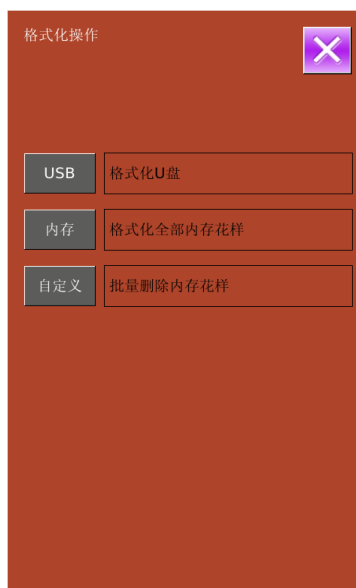

① 按“USB”键，进入U盘格式化

按回车键  全部格式化 U 盘文件

按退出键  退出格式化 U 盘



② 按“内存”按键，格式化内存花样

格式花样包括：

- 普通花样
- 连续缝花样
- 循环缝花样
- 登记的 P 花样

按回车键  全部格式化 U 盘文件

按退出键  退出格式化 U 盘

※ 格式化内存花样会将内存中存在的全部花样文件删除，请谨慎操作！

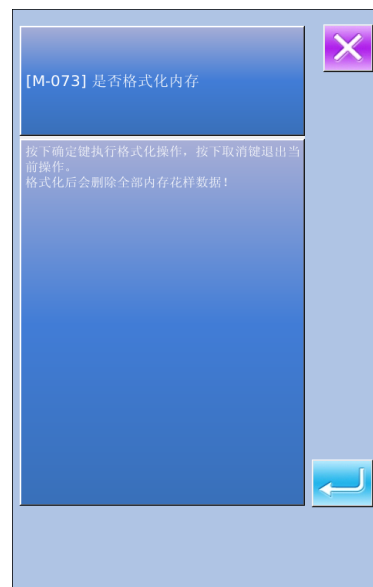

③ 按“自定义”键，进入批量删除功能

在该界面下，会显示当前内存中存在的所有花样文件，点按相应的按键完成批量删除功能。

自定义功能的操作：

- A. 利用“上箭头”、“下箭头”键进行翻页
- B. 利用下面三种操作，选择花样

➢ 按  选择全部花样，

➢ 按  反向选择

➢ 点击花样号码按钮

C、按  完成批量删除功能

D、按退出键  退出到格式化操作界面。

※ 蓝色标示的文件是 vdt 格式文件



- ④ 在自定义格式化界面下，按  键，显示当前内存中花样占用的空间，及各类型花样的个数

按退出键  退出到上一界面。

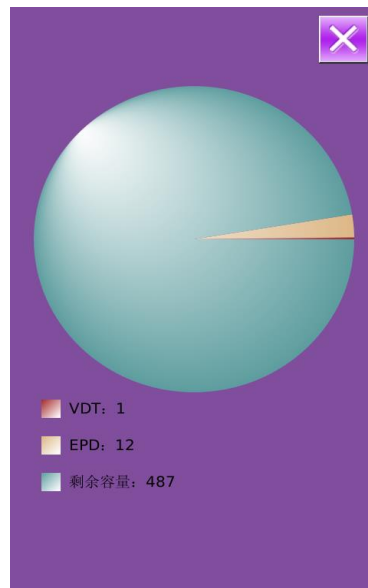

## 7.13 参数备份还原

用户可以根据需要保存 8 组 U 级参数数值，用于以后的调用。

在设置模式等级 2 下，按  键进入参数还原备份界面，如右图所示：

清除键：清除全部已经保存的自定参数

保存键：保存当前参数

恢复键：恢复当前参数

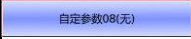
- ① 点击  ~  其中任意一键，以确定参数保存位置，然后点击「保存」键进行保存。

- ② 观察「自定参数 xx (有/无)」键显示内容，如果括号内显示为「有」的则表示该位置上存储了用户参数。

，例如 。

- ③ 选择已经存储参数的自定参数键，按下「恢复」键就会重新加载相应的参数设定值。

- ④ 按下「清除」键会清楚全部已存参数。

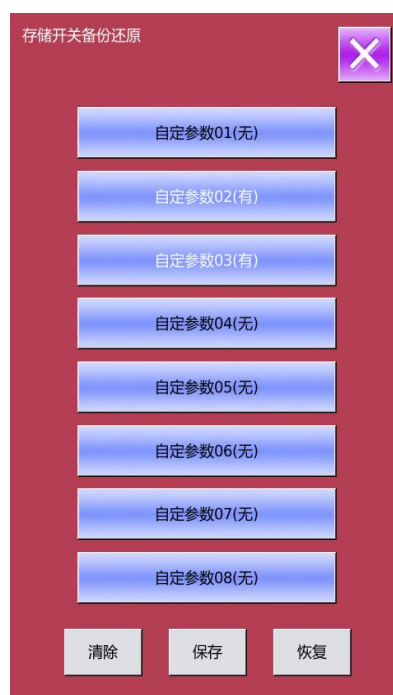



## 8 通讯功能

通信功能完成以下几项功能：

- 把其它缝纫机编制的缝制数据或打版软件编制后的缝制数据下载到缝纫机；
- 向U盘或计算机里加载缝制数据。
- 从U盘加载参数
- 将操作头中保存的参数导入到U盘中
- 操作头软件升级

### 8.1 关于可以处理的数据

可以处理的缝制数据有以下2种，其数据形式如下。

数据名称	后缀	数据内容
向量形式数据	[0-9][0-9][1-9].vdt	编制的落针点数据。
参数数据	[0-9][0-9][1-9].epd	缝纫机编制的缝制形状。

往U盘保存数据时，请保存到DH\_PAT文件夹里，否则就不能读取文件。

### 8.2 功能操作

#### ① 显示通信界面

在数据输入界面，按通信键之后，显示出通信界面。

#### ② 选择相应操作

该界面下可选择的功能，分为三类：

- 花样传输
- 参数传输
- 软件升级

点按相应的图标，进行功能操作。

#### ③ 按通信键退出通讯功能



## 8.3 花样传输

### ① 显示通信界面

在通讯界面下，按：

A：从U盘中向操作头导入花样

B：将操作头中保存的花样导出到U盘中

U盘的路径：DH\_PAT

- ※ 从U盘导入花样时，请将花样文件保存在U盘的DH\_PAT目录中
- ※ 从操作头导出花样时，导出的花样文件保存在U盘的DH\_PAT中
- ※ U盘中的花样命名方式

从U盘导入花样时，请遵守下面的规则命名：

文件名：三位数字，001~500

后缀名：epd、vdt（大小写无关）

举例：

正确的文件命名：001.epd、100.vdt、003.EPD、102.VDT

其他的命名方式不正确，系统不能识别

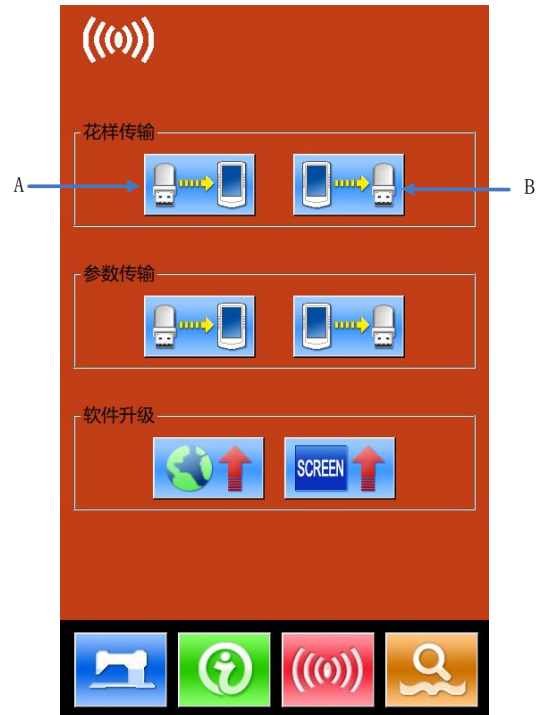

### ② 按A指示键，进入从U盘向操作头导入花样界面

A、利用【上箭头】、【下箭头】键进行翻页

B、利用下面三种操作，选择花样

- 按  选择全部花样，
- 按  反向选择
- 点击花样号码按键

C、按  完成导入花样功能

D、按  完成选中花样的删除功能

E、按退出键  退出到通讯界面。



E、按  键，出现右图所示界面，

输入要存入的花样号；

按回车键 ，可以将选中的U盘中的花样，  
存入到指定的花样号中，并返回上一界面；

按退出键  退出到上一界面。

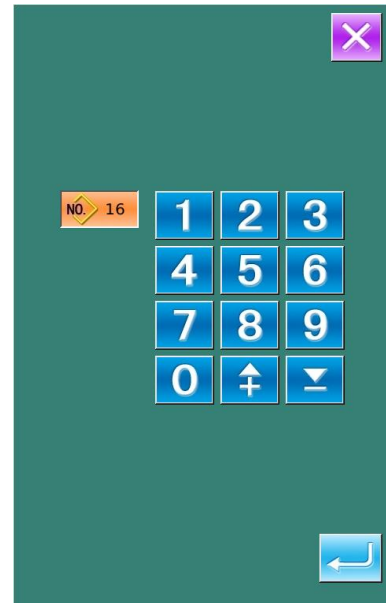

③ 按B指示键，完成操作头的花样导出到U盘中

A、利用【上箭头】、【下箭头】键进行翻页

B、利用下面三种操作，选择花样

➤ 按  选择全部花样，

➤ 按  反向选择

➤ 点击花样号码按键

C、按  完成选中花样的删除功能

D、按  完成导出花样功能

E、按退出键  退出花样导出功能界面

F、在该界面下，按  键，显示当前内存中花样  
占用的空间，及各类型花样的个数

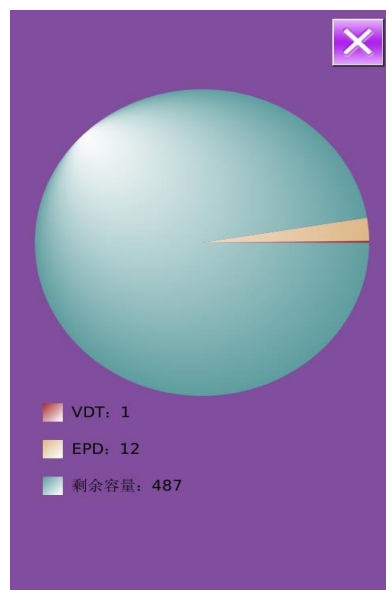

※ 蓝色标示的文件是vdt格式文件

## 8.4 参数传输

### ① 显示通信界面

A: 从U盘中向操作头导入参数

B: 将操作头中保存的参数导出到U盘中

- ※ 从U盘导入参数时，请将参数文件保存在U盘的DH\_PARA目录中，并命名为：PS\_Param
- ※ 从操作头导出参数时，导出的参数文件保存在U盘的DH\_PARA中，参数文件：PS\_Param
- ※ 参数文件是二进制文件，对文件的操作在操作头上完成，不要手动修改文件，以免影响使用。

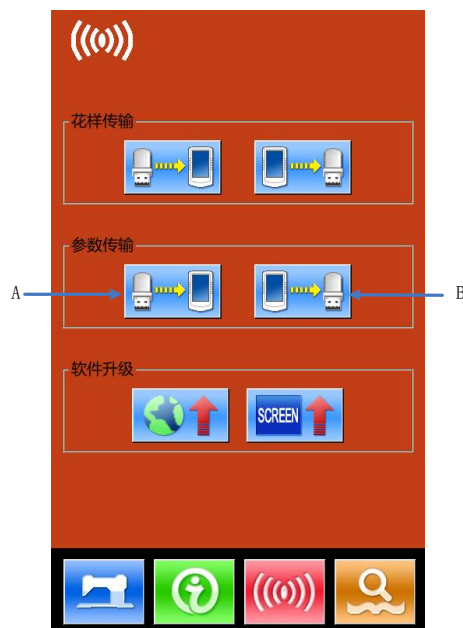

### ② 按A指示键，完成从U盘向操作头导入参数

A、按回车键  完成从 U 盘向操作头导入参数并退出

B、按退出键  直接退出

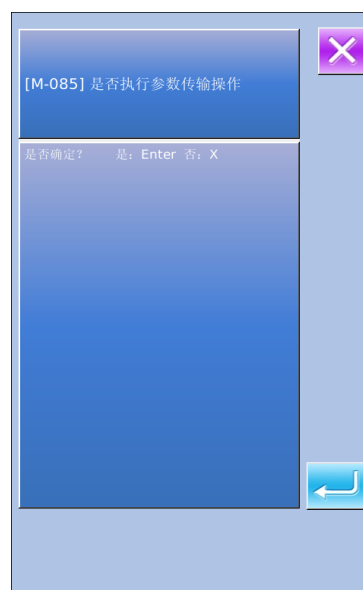

③ 按B指示键，完成操作头的参数导出到U盘中

A、按回车键完成从操作头向 U 盘导出参数并退出

B、按退出键直接退出

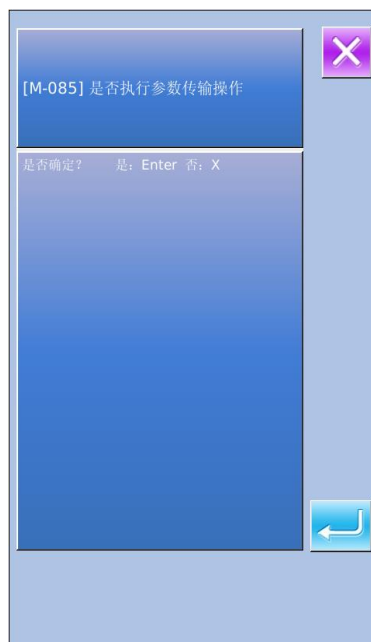

## 8.5 软件升级

① 显示通信界面

A: 软件升级

B: 批量选择升级开机画面

在通讯界面下，按A键进入软件升级界面。

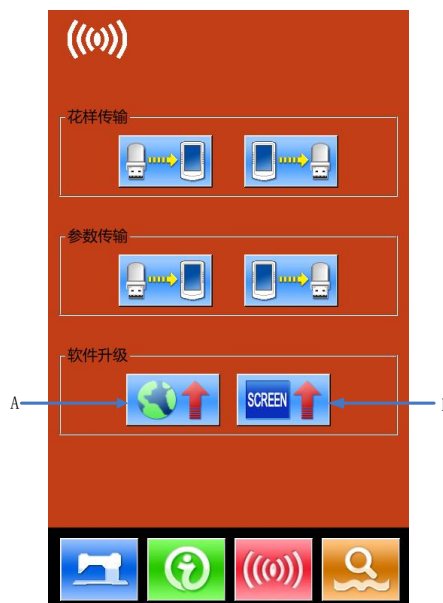

## ② 升级类型选择

软件升级包括:

- ◆ 操作头程序
- ◆ 图标
- ◆ 显示字库
- ◆ 开机画面

按  和  键进行翻页

A、按回车键  完成选中功能的升级，并退出

B、按退出键  直接退出

C、各个功能键能同时多选，系统顺序执行相应的升级功能

D、升级完成后，关机重启即可

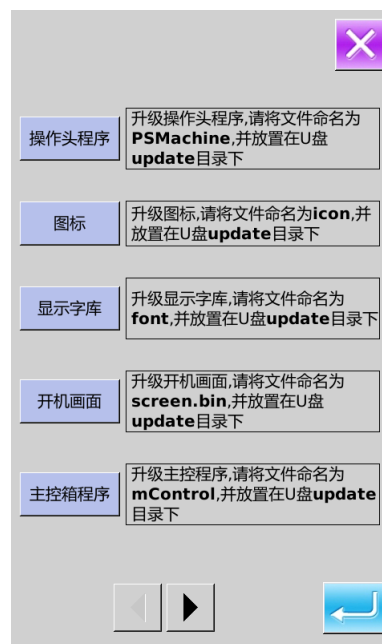

## 9 信息功能

信息功能，有下列3 种功能。

- 1) 可以指定机油更换时期，机针更换时期，清扫时期等，超过了指定事件之后，进行警告通知。
- 2) 利用显示目标值和实际值功能，可以提高生产小组完成目标的意识，可以一目了然地确认进度。
- 3) 显示穿线示意图。

### 9.1 查看维修保养信息

#### ① 显示信息界面

在数据输入界面，按开关密封部的信息按键（A）之后，信息界面被显示出来。

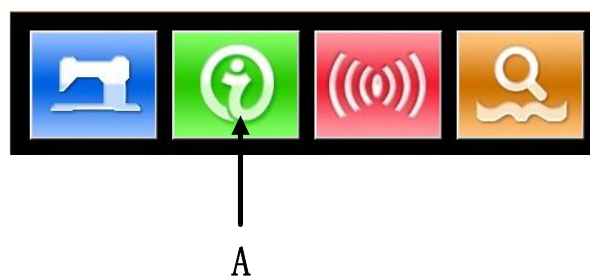

② 显示保养维修界面。

请按信息界面的保养维修信息界面显示按键

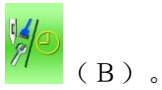

( B ) 。

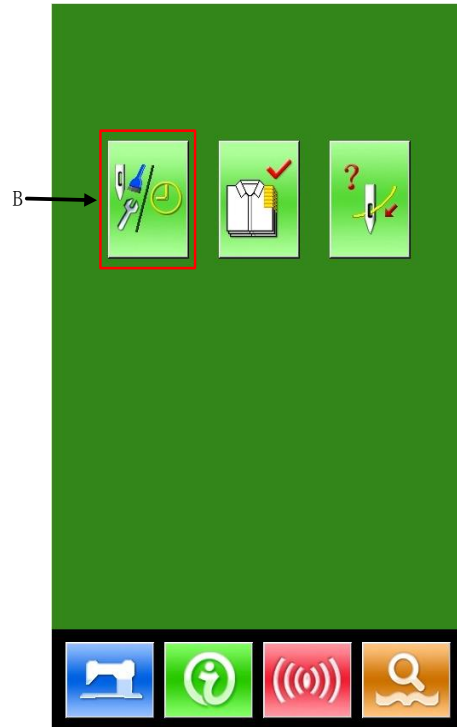

在保养维修信息界面上，有以下3 个项目的信息被显示出来。



: 更换机针(千针)

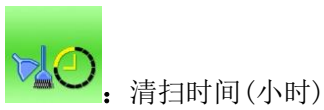

: 清扫时间(小时)

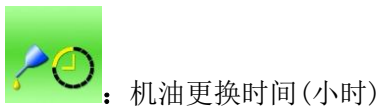

: 机油更换时间(小时)

各项目显示在按键(C)，通知检修的间隔显示在D，至更换的剩余时间显示在E。

点按相应的按键，可以清除至更换的剩余时间。

按退出键直接退回到信息界面。

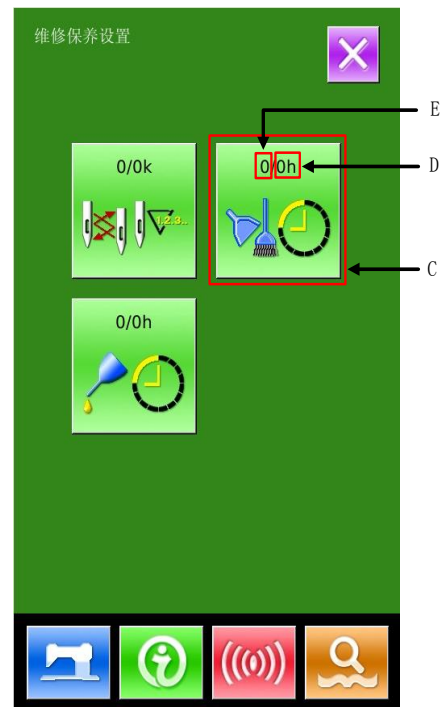



## 9.2 维修保养时间设置

### ① 显示信息界面（维修人员等级）

在数据输入界面，按信息按键（A）约3 秒钟之后，信息界面（维修人员等级）被显示出来。

维修人员等级时，有6 个按键被显示出来。

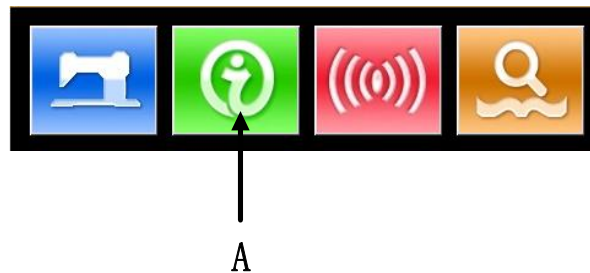

### ② 信息界面功能

维修人员等级时，有六项功能显示：

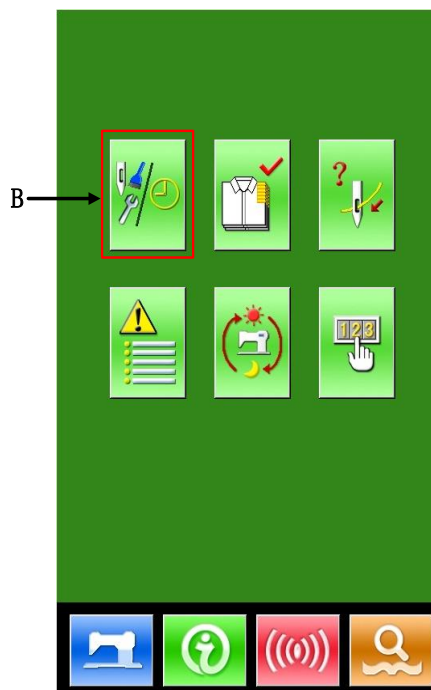
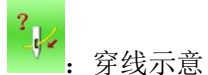
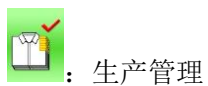

请按信息界面的保养维修信息界面显示按键



（B），进入维修保养界面。

### ③ 维修保养设置

在保养维修信息界面上，显示出与通常的维修保养信息界面一样的信息。按了想变更维修保养时间的项目按键(C)之后，相关输入界面被显示出来。



比如按下  键，则可以设置清扫时间。



按退出键  直接退回到信息界面。

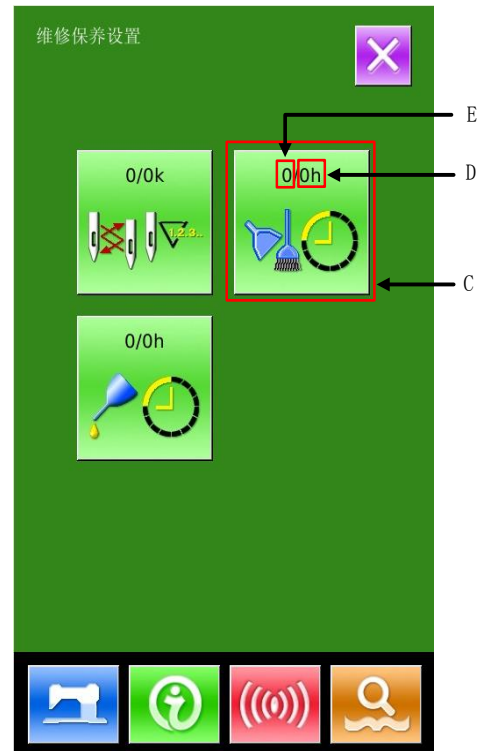

### ④ 设置维修保养项

把维修保养项设定值设定为0 之后，则停止维修保养功能。

维修保养设置项包括：

- ◆ 机针更换时间设定
- ◆ 清扫时间设定
- ◆ 机油更换时间设定

按相应的图标，进入设置界面：

A、通过数字键盘输入维修保养项的设定值。

B、按回车键  之后确定输入。

C、按退出键  直接退回到维修保养界面。

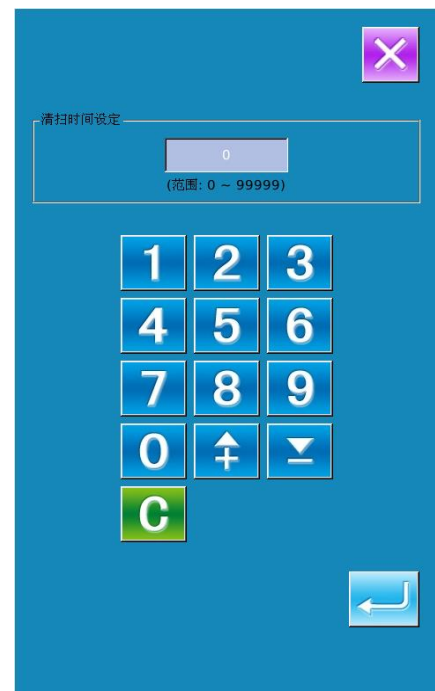

## 9.3 警告的解除方法

到了指定的维修保养时间之后，信息提示界面被显示出来。要清除维修保养时间时，请按回车键 。

在清除维修保养时间之前，每1 缝制结束后显示信息提示界面。

各项目的信息提示号码如下。

- 机针更换：M031

- 机油更换时间：M032
- 清扫时间：M033

## 9.4 生产管理信息

在生产管理界面上，指定开始，可以进行从开始到现在的生产件数，生产目标件数的显示等。  
生产管理界面的显示方法有以下2种：

- 从信息界面显示
- 从缝制界面显示

### 9.4.1 从信息界面显示

#### ① 显示信息界面。

在数据输入界面按了开关部的信息键（A）之后，信息界面被显示出来。

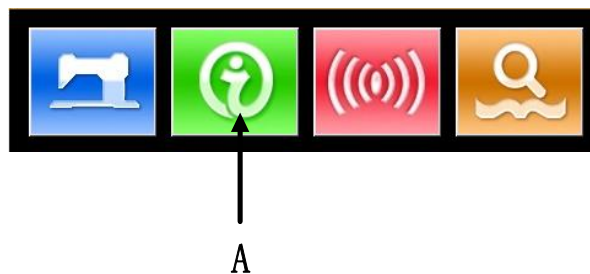

#### ② 显示生产管理界面。

请按信息界面的生产管理界面显示按键（B）。  
生产管理界面被显示出来（如右图所示）。

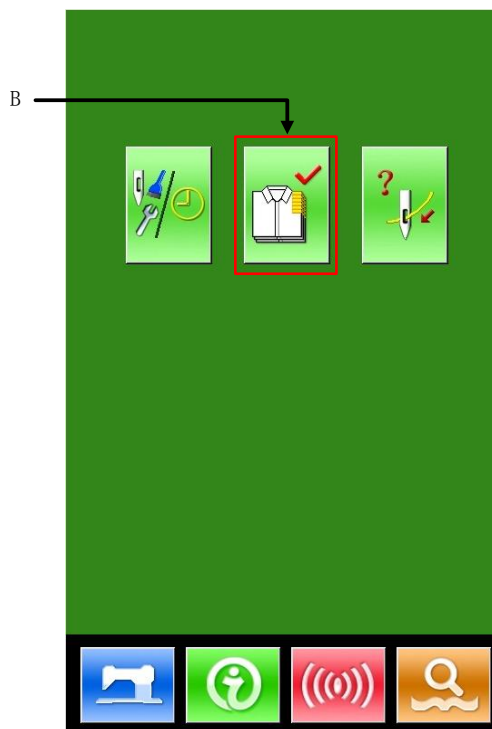

生产管理界面上显示有下列5个项目的信息。

#### A：目标值

依照间隔时间自动地显示出截止现在的目标缝制件数。

#### B：实际值

自动地显示已经缝制的件数。

#### C：最终目标值

设置最终目标的缝制件数。

#### D：目标值间隔时间

设置完成一个工序需要的时间（秒）。

#### E：实际计件间隔

设置实际完成一个工序的间隔。

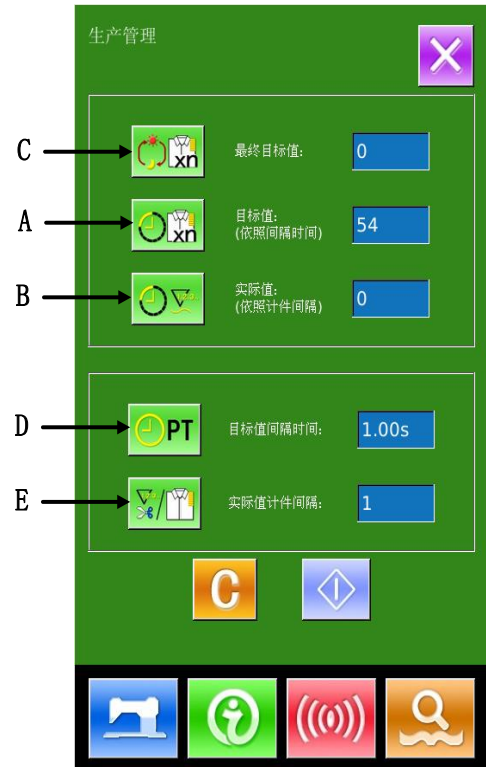

## 9.4.2 从缝制界面显示

### ① 显示缝制界面。

在数据输入界面按了准备键之后，缝制界面被显示出来。

### ② 显示生产管理界面。

在缝制界面，按了信息按键（A）之后生产管理界面被显示出来。

显示内容和功能与上述9.4.1节相同。

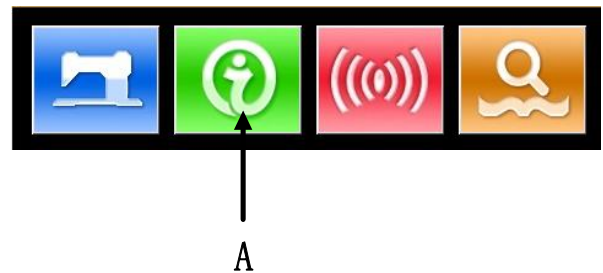

### 9.4.3 生产管理信息设定

#### ① 显示生产管理界面。

按下 ，显示出生产管理界面。

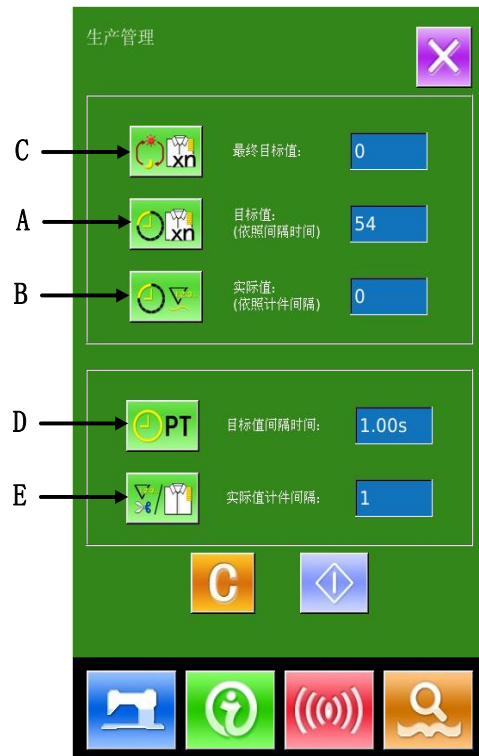

#### ② 输入最终目标值。

首先，请输入从现在开始进行缝制工序的生产目

标件数。按了最终目标值按钮  (C) 之后，最终目标值输入界面被显示出来。

请用数字键或加减按钮输入希望的数值。输入

后，请按确定按钮 ，按下退出键  退出。

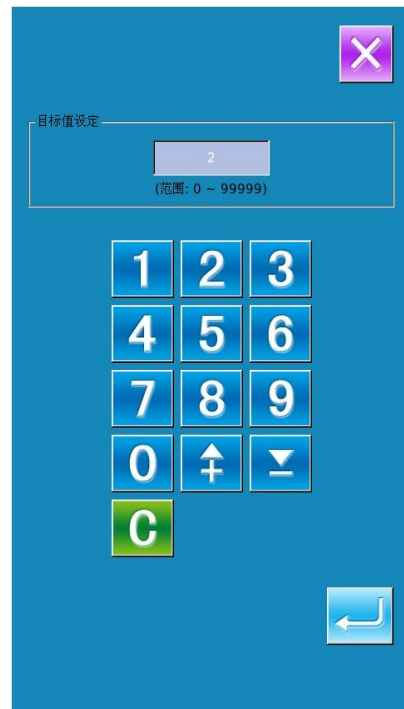



### ③ 输入间隔时间。

然后，请输入1 工序需要的间隔时间。按了前页

的间隔时间按键  (D) 之后，间隔时间输入界面被显示出来。

请用数字键或加减键输入希望的数值。输入

后，请按确定按键 ，按下退出键  直接退出。

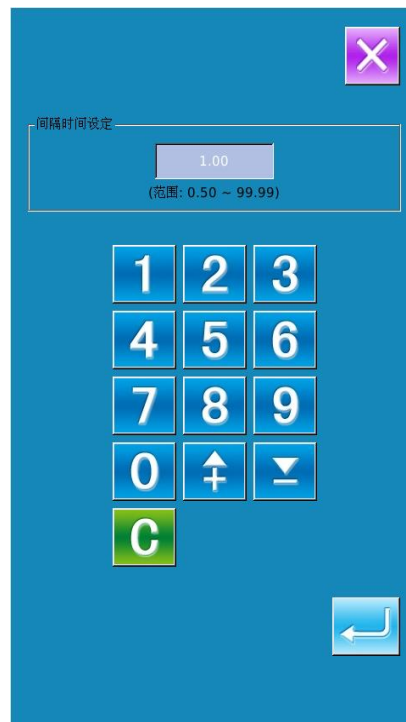



### ④ 输入切线次数。

然后，请输入平均1 工序的切 次数。按了前页

的切 次数按键  (E) 之后，切线次数的输入界面被显示出来。

请用数字键或加减键输入希望的数值。输入

后，请按确定按键 ，按下退出键  直接退出。

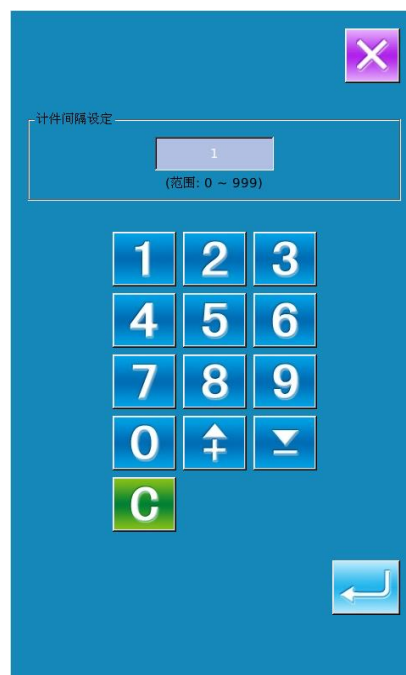

⑤ 开始车生产件数的计数。

按  键 (I) 之后, 【最终目标值】 【目标值】 【实际值】 变灰, 并开始生产件数的计数。

**最终目标值:** 可以作为参考时间

**目标值:** 目标值按照【目标值间隔】设定的时长, 开始计时, 每过一个时间间隔增1。

**实际值:** 当通过“9.4.2从缝制界面显示”进入时, 实际值按照【实际值计件间隔】设定的值, 开始计件, 每缝完一件增1。

通过设置目标值和实际值可以对比每缝一件的生产效率是提高了还是降低了。

⑥ 停止计数。

计数状态下, 停止键  被显示出来。按了停止按钮

之后, 停止计数。停止后, 在停止按钮

的位置显示出计数按钮 。需要进行

计数时, 请再次按计数按钮 。在按了清除按钮

 之前, 计数的数值不被清除。

按下退出键  直接退出返回。



⑦ 清除计数值。

清除计数的值时，让计数器为停止计数状态，按下清除按钮 。

可以被清除的值为现在的目标值  和实际

值 。

(注：仅在停止计数状态时清除按钮可以显示。)

按下清除按钮  之后，显示出清除确认界面。

在清除确认界面，按下确定按钮  确认清除，

按下退出键  直接退出。

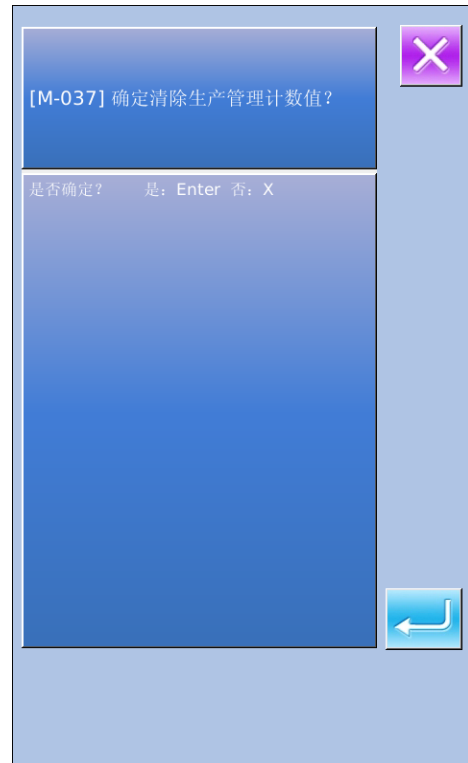

### 9.5 显示穿线图

信息界面按下穿线按钮  (C) 之后，上穿线图被显示出来。穿线时，请参阅。

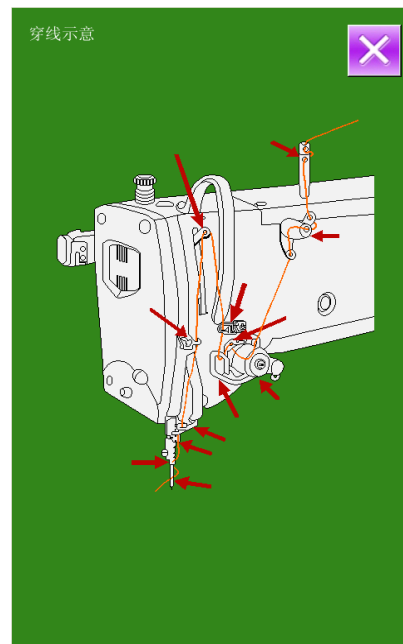
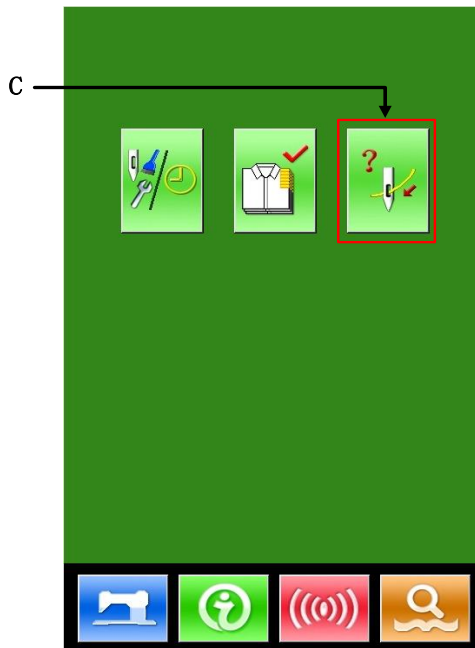



## 9.6 报警记录

- ① 维修人员等级时，按下  可以查询机器的报警记录信息。



- ② 按  查询记录

如图，显示报警信息和出现的次数

操作键功能：

A、按下 、 进行翻页

B、按下退出键  退出查询操作。

C、按下清除键  清除保留的报警记录

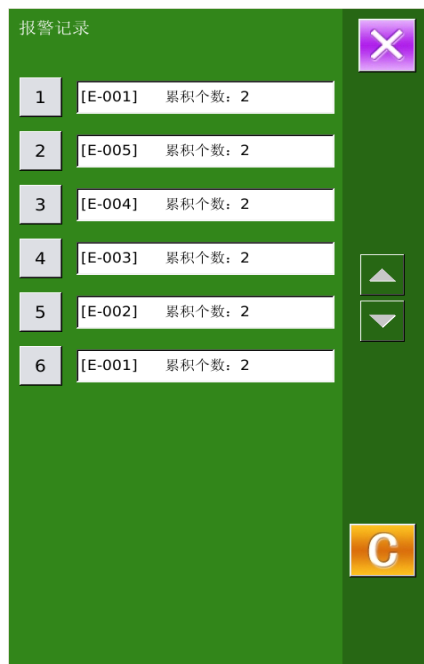

③ 按报警提示栏左边的序号键，显示报警记录的详细信息

例如按“1”提示右边的信息

A、按退出键退出。

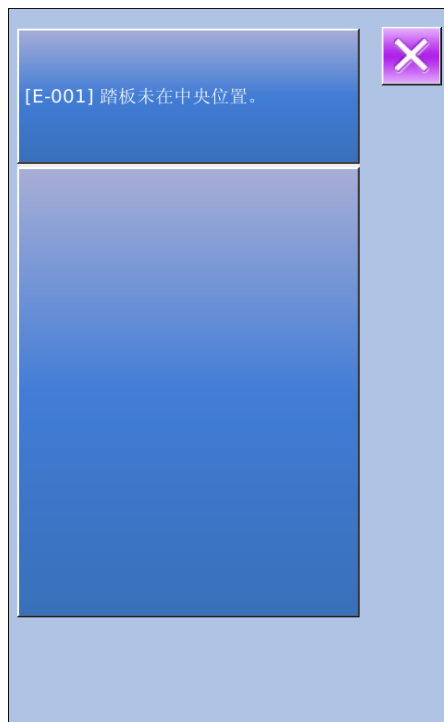

## 9.7 运转记录

① 维修人员等级时，按下可以查询机器的运转信息。



② 运转记录包括:

-  : 机器累积运转时间 (小时单位)
-  : 机器累积切线次数
-  : 机器累积上电时间 (小时单位)
-  : 机器累积针数 (1000 针单位)

A、按退出键  退出

B、按清除键  清除记录

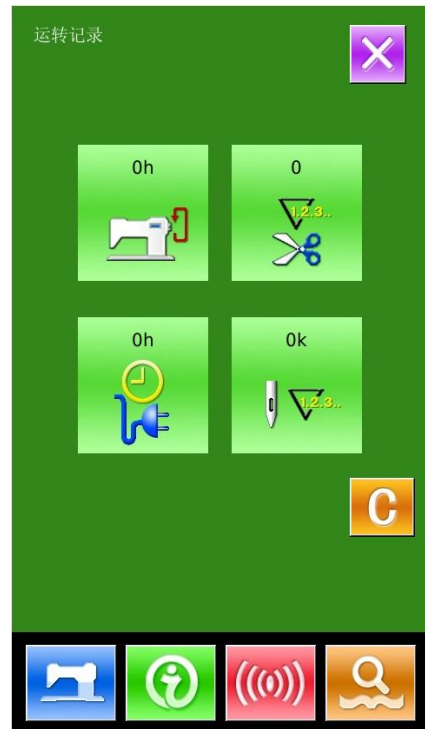

## 9.8 分期密码设置

① 维修人员等级时, 按下  可以设置分期密码

该界面下会显示输入用户 ID 界面, 输入正确的厂家 ID 后即进入密码管理模式, 主要用于用户分期密码的设置和管理。

- ◆ 可以最多设置 10 个不同的密码发作日期。
- ◆ 系统可以显示厂家设置的密码信息。

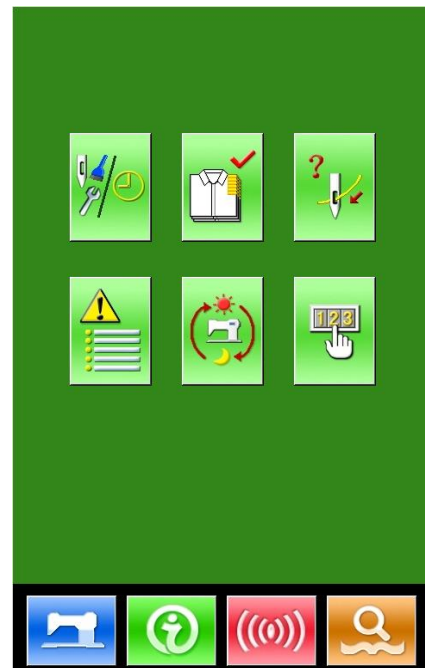

② 按下  后要求输入厂家 ID

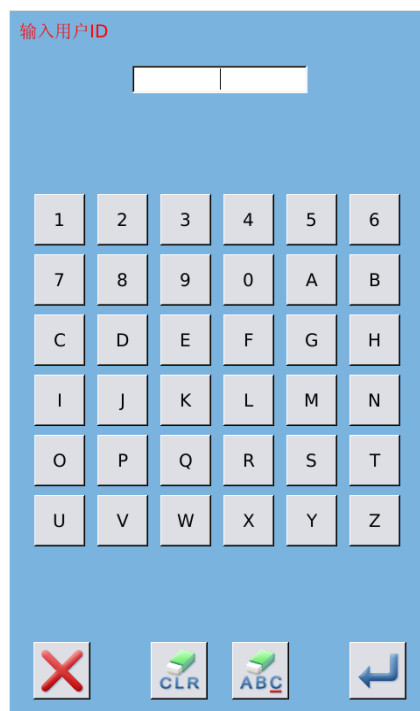

③ 输入正确的厂家 ID 后，进入密码设置界面  
分期密码设置步骤：  
A、继续输入其他的分期密码

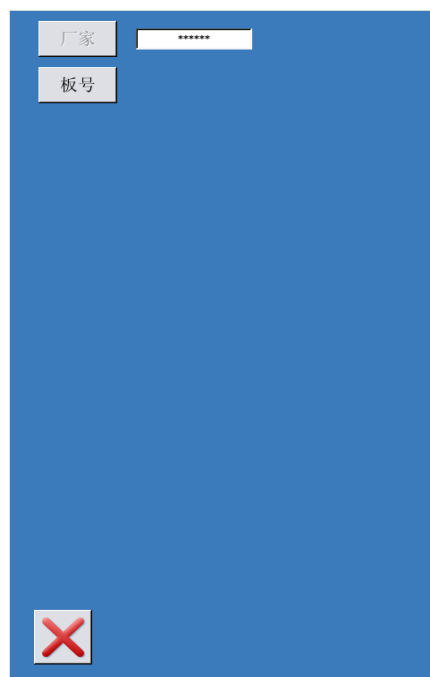

④ 输入板号

按下【板号】键，进入板号输入界面，输入板号

后，按下完成板号输入界面

※ 板号为四位，范围 0~9999

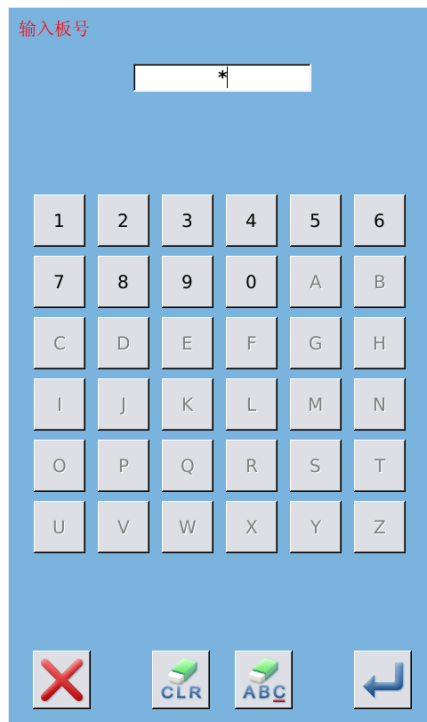

⑤ 输入系统时钟

按下【时钟】键，进入系统时钟设置界面，确定系统时钟



## ⑥ 输入超级密码

按下【超级密码】键，进入超级密码设置界面，  
输入超级密码

※ 最多可输入 9 位总密码

※ 密码输入要求确认，两次密码必须一致

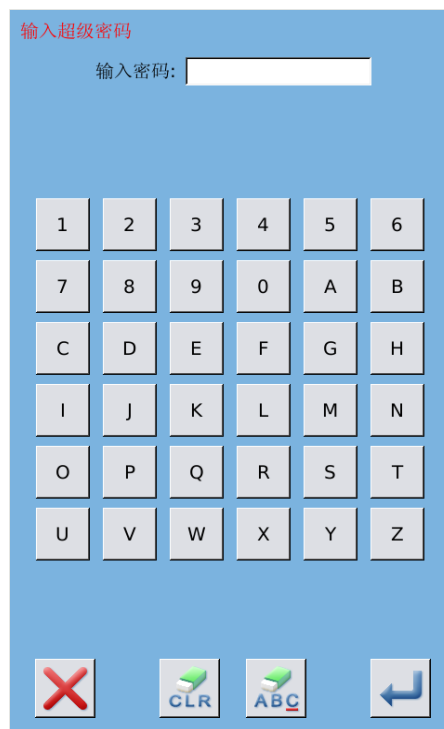

## ⑦ 输入分期密码

按下【密码-1】键，进入第一次密码到期界面，  
要求输入第一个有效日期，选择合适的日期后，

按确认，然后进入密码设置界面，输入密码

※ 日期不能小于系统日期

※ 密码输入要求确认，两次密码必须一致



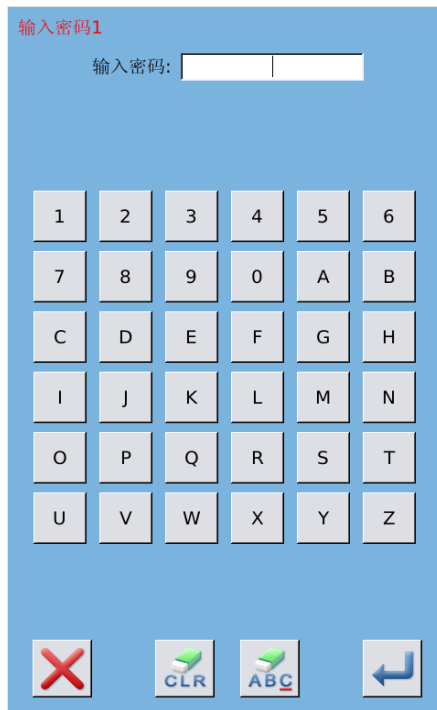

⑧ 输入其他的分期密码

其他分期密码的设置和⑦相同，参考⑦的设置

※ 下一个有效日期必须大于上一个有效日期



## ⑨ 保存密码

A、密码输入完成后，按完成密码保存

B、密码保存成功，显示【密码保存成功】界面，

按完成密码保存并退回到【信息主界面】

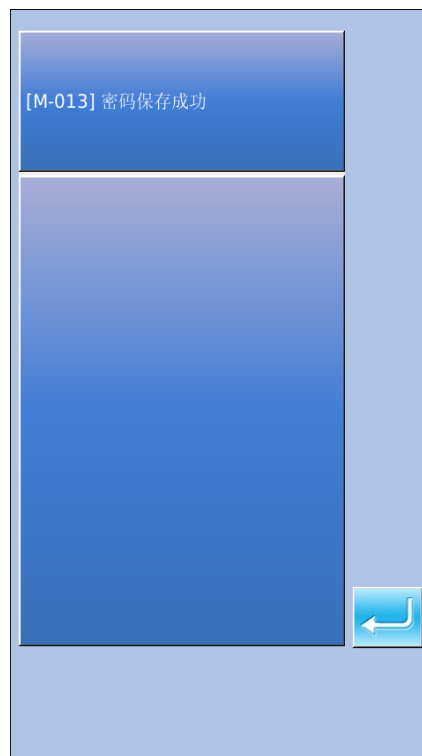



⑩ 主动清除密码

主动清除密码是指在分期密码发作前主动清除密码的设置

- A、进入密码的方法同密码设置
- B、输入正确的厂家 ID 后，显示右边的界面
- C、系统显示当前时钟和各个分期密码发作日期

D、按下 ，从前向后依次删除分期密码

连续输入正确的分期密码后清除当前期的密码，当输入是超级密码时，则全部清除；

密码清除后会以红色显示清除的分期日期；

如果全部密码清除完毕，则自动退出，返回到信息主界面。

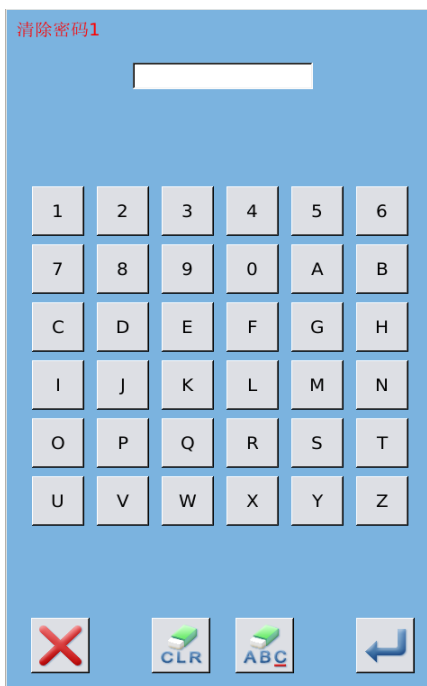
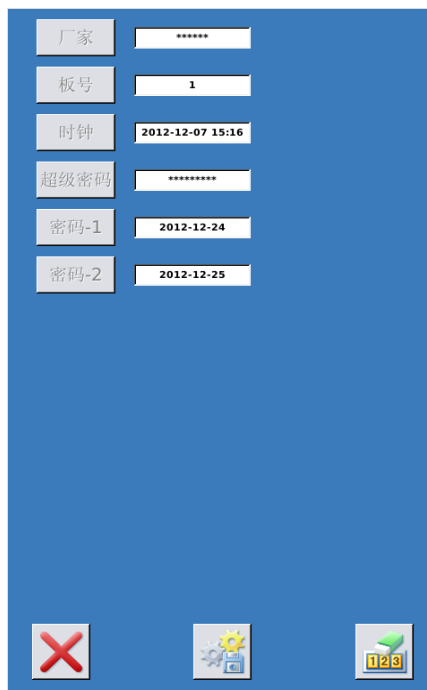

**⑪ 密码发作时清除**

如果系统设置了密码，并且没有清除，则使用至密码发作日期时，会遇到密码发作。

此时若继续使用，必须输入密码才能继续正常使用。

A、有效密码包括当期提示的密码和超级密码。



B、若输入的是当期密码，则清除当期密码。清除当前密码后，若后面没有密码，则机器不再会出现密码发作的问题。

C、若输入的是超级密码，则全部清除分期密码。

## 10 附录 1

### 10.1 报警信息一览表

故障号	故障名称	复位方法
E-001	脚踏板未在中央位置	自恢复错误
E-002	机器进入急停状态	按复位键
E-004	主电压（300V）过低	关机
E-005	主电压（300V）过高	自恢复错误
E-007	IPM 过压或过流	关机
E-008	辅助设备电压（24V）过压异常	关机
E-009	辅助设备电压（24V）欠压异常	关机
E-012	IPM 过流	请关闭电源，检查系统硬件
E-013	编码器故障或未连	关机
E-014	电机运行异常	关机
E-015	超过缝制区域	关机
E-016	针杆上位置异常	按下确定键 
E-017	断线检测错误	按下确定键 
E-018	切刀位置异常	关机
E-019	急停开关未在正常位置	自恢复错误
E-020	确认机头部放倒	关机
E-024	操作头与缝纫机连接错误	关机
E-025	X 原点检测异常	关机
E-026	Y 原点检测异常	关机
E-027	压脚原点检测异常	关机
E-028	切面线原点检测异常	关机
E-029	切底线原点检测异常	关机
E-030	步进驱动器通讯异常	关机
E-031	步进电机过流	关机
E-032	步进驱动电源异常	关机
E-033	摆针超出缝制范围	关机
E-035	切面线马达异常	关机
E-036	切底线马达异常	关机
E-037	切布刀不能返回	按下确定键 
E-038	切布刀传感器异常	关机
E-041	步进驱动器版本错误	关机

故障号	故障名称	复位方法
E-042	花样传输错误	按下确定键 
E-043	参数传输错误	按下确定键 
E-044	机头板 EEROM 读写错误	按下确定键 
E-060	步进过流 1	关机, 摆针电机电流异常, 步进驱动板或摆针电机有故障, 可通过更换步进驱动板或摆针电机进行排查
E-061	步进过流 2	关机, 切刀电机电流异常, 步进驱动板或切刀电机有故障, 可通过更换步进驱动板或切刀电机进行排查
E-062	步进超速 1	关机, 摆针电机转速异常, 步进驱动板或摆针电机有故障, 可通过更换步进驱动板或摆针电机进行排查
E-063	步进超速 2	关机, 切刀电机转速异常, 步进驱动板或切刀电机有故障, 可通过更换步进板或切刀步进电机进行排查
E-064	步进超差 1	关机, 摆针步进电机位置异常, 首先查看机械是否顺畅, 是否出现卡死现象, 排除机械原因, 如果机械上无卡点可通过更换步进板或摆针步进电机进行排查
E-065	步进超差 2	关机, 切刀步进电机位置异常, 首先查看机械是否顺畅, 是否出现卡死现象, 排除机械原因, 如果机械上无卡点可通过更换步进板或切刀电机进行排查
E-066	指令覆盖 1	请关闭电源
E-067	指令覆盖 2	请关闭电源
E-068	MD1 读取错误	关机, 步进驱动板与主板通信异常, 可检查通讯线缆是否连接可靠, 排除线缆问题, 如确认线缆连接无问题, 可通过更换步进驱动板
E-069	MD1 通讯错误	关机, 步进驱动板与主板通信异

故障号	故障名称	复位方法
		常,可检查通讯线缆是否连接可靠,排除线缆问题,如确认线缆连接无问题,可通过更换步进驱动板
E-090	步进过流 3	关机,送布电机电流异常,步进驱动板或送布电机有故障,可通过更换步进驱动板或送布电机进行排查
E-091	步进过流 4	关机,压脚电机电流异常,步进驱动板或压脚电机有故障,可通过更换步进驱动板或压脚电机进行排查
E-092	步进超速 3	关机,送布电机转速异常,步进驱动板或送布电机有故障,可通过更换步进驱动板或送布电机进行排查
E-093	步进超速 4	关机,压脚电机转速异常,步进驱动板或压脚电机有故障,可通过更换步进驱动板或送布针电机进行排查
E-094	步进超差 3	关机,送布步进电机位置异常,首先查看机械是否顺畅,是否出现卡死现象,排除机械原因,如果机械上无卡点可通过更换步进板或送布步进电机进行排查
E-095	步进超差 4	关机,压脚步进电机位置异常,首先查看机械是否顺畅,是否出现卡死现象,排除机械原因,如果机械上无卡点可通过更换步进板或压脚步进电机进行排查
E-096	指令覆盖 3	请关闭电源
E-097	指令覆盖 4	请关闭电源
E-098	MD2 读取错误	关机,步进驱动板与主板通信异常,可检查通讯线缆是否连接可靠,排除线缆问题,如确认线缆连接无问题,可通过更换步进驱动板
E-099	MD2 通讯错误	关机,步进驱动板与主板通信异常,可检查通讯线缆是否连接可靠,排除线缆问题,如确认线缆连接无问题,可通过更换步进驱动板
E-100	主轴零位错误	请关闭电源

故障号	故障名称	复位方法
E-101	冷却风扇异常	请关闭电源
E-102	压脚汽缸 1 位置异常	请关闭电源
E-103	压脚汽缸 2 位置异常	请关闭电源
E-254	未定义错误	按下确定键 

## 10.2 信息提示一览表

信息号	信息名称	子信息内容
M-001	设置值太大	请输入范围内数值
M-002	设置值太小	请输入范围内数值
M-003	存储参数异常	请按下确定键恢复出厂设置
M-004	通讯错误	操作头与控制箱通讯异常
M-005	操作头与控制箱类型不符	请核对机型和软件版本
M-006	硬件时钟故障	发现硬件时钟故障，请联系厂家维修
M-007	密码错误	请重新输入
M-008	输入用户 ID 有误	请重新输入
M-009	确认密码失败	请重新输入密码
M-010	禁止修改系统时间	设置了分期密码，不能修改系统时间
M-011	密码文件写入失败	
M-012	密码文件读取失败	
M-013	密码保存成功	
M-014	清除全部密码失败	密码文件无法被删除
M-015	清除密码失败	清除密码后，文件写入异常
M-016	密码文件被恶意删除	用户设置的分期密码被恶意删除，请关机
M-017	输入不能为空	请输入密码
M-018	当前密码不符	请重新输入当前密码
M-019	新密码不一致	请重新输入新密码并再次确认
M-020	分期密码不能和总密码相同	请重新输入密码
M-021	确定进入触摸屏校正模式	其否确定？是：enter 否：X
M-022	触摸屏校正成功	校正成功，请关闭电源后重启
M-023	触摸屏校正失败	请重新校正
M-024	SRAM 初始化	清除掉 SRAM 总的全部数据，请关电并将拨码开关位置还原
M-025	关机，再见	
M-026	无报警记录	
M-027	确定清除报警记录	其否确定？是：enter 否：X
M-028	USB 盘已拔出	USB 盘已经拔出
M-029	U 盘中没有发现花样数据	

M-030	保存软件版本成功	软件版本已经成功保存到 U 盘根目录下
M-031	更换机针	更换机针设定值已到达, 请更换机针
M-032	更换机油	更换机油时间设定值已到达, 请更换机油
M-033	清扫机器	清扫机器时间设定值已到达, 请清扫机器
M-034	确定清除更换机针计数值	其否确定? 是: enter 否: X
M-035	确定清除更换机油计数值	其否确定? 是: enter 否: X
M-036	确定清除清扫时间计数值	其否确定? 是: enter 否: X
M-037	确定清除生产管理计数值	其否确定? 是: enter 否: X
M-038	超出缝制范围	请确保花样数据在风中范围以内
M-039	针数超出范围	请减少花样针数
M-040	加载出厂花样	内存中没有花样, 需要加载出厂花样
M-041	花样数据不存在	请重新读取或打板输入
M-042	花样数据错误	当前花样数据错误, 将由出厂花样替换
M-043	花样信息文件打开失败	恢复出厂花样配置
M-044	花样已存在	不能执行覆盖操作
M-045	花样个数已满	请删除不用的花样后再执行操作
M-046	是否覆盖花样	其否确定? 是: enter 否: X
M-047	连续缝花样打开失败	花样文件错误, 将会被删除
M-048	循环缝花样打开失败	花样文件错误, 将会被删除
M-049	是否删除花样数据	按下确定键执行删除操作, 按下取消键退出当前操作
M-050	是否删除选中的文件	其否确定? 是: enter 否: X
M-051	花样被引用, 不能删除	请在其他类型花样中解除引用
M-052	请至少保留一个花样	最后一个花样不能被删除
M-053	输入号码不存在	请重新输入
M-054	缝制计数器达到设定值	请按下确定键清除
M-055	计件计数器达到设定值	请按下确定键清除
M-056	花样打板运算异常	
M-057	切刀尺寸异常	
M-058	打板生成缝制码错误	
M-059	超出针距最大间隔	
M-060	花样文件类型错误	
M-061	是否删除选中子花样	其否确定? 是: enter 否: X
M-062	是否删除全部子花样	其否确定? 是: enter 否: X
M-063	是否恢复出厂设置	确定键执行操作, 取消键退出操作
M-064	EEPROM 剪刀参数异常	按下确定键恢复出厂值
M-065	是否还原所有设定	其否确定? 是: enter 否: X
M-066	是否还原选择项目	其否确定? 是: enter 否: X

M-067	未选择项目	请选择一个或几个参数项
M-068	确定清除运转记录	其否确定? 是: enter 否: X
M-069	成功	已成功执行当前操作
M-070	失败	当前操作执行失败
M-071	当前循环缝花样为空或引用的连续缝花样为空	请重新编辑
M-072	是否格式化 U 盘	按下确定键执行格式化操作, 按下取消键退出当前操作。格式化后会删除全部 U 盘文件!
M-073	是否格式化内存	按下确定键执行格式化操作, 按下取消键退出当前操作。格式化后会删除全部内存花样数据!
M-074	请关机	当前操作结束, 请重新启动机器
M-075	恢复参数成功	恢复参数成功, 请重新启动机器
M-076	打开文件失败	打开文件失败
M-077	没有选中升级条目	请选中要升级的条目, 至少要选中一个条目
M-078	选中的升级条目中有些不存在	不存在升级文件的条目返回后将会取消选中, 如果要升级剩下的条目, 请再次确认
M-079	升级成功	升级成功, 请重新启动机器
M-080	拷贝文件失败, 请检查磁盘空间是否已满	请检查磁盘空间是否已满
M-081	拷贝文件失败, 请检查是否拔出了 USB 盘	请检查是否拔出了 USB 盘
M-082	文件读写错误	文件读写错误
M-083	升级主控程序时校验失败	
M-084	花样数据不能删除	被选中的缝制数据正在使用
M-085	是否执行参数传输操作	其否确定? 是: enter 否: X
M-086	转换花样无法打开	请确认花样文件
M-087	转换花样格式错误	请确认花样文件
M-088	转换花样数据超长	请确认花样文件
M-089	打板生成数据错误	EPD 参数存在异常现象
M-090	禁止修改计数器	当修改时, 请关闭设定
M-091	连续缝花样为空	请重新选择

### 10.3 常见故障处理

故障编号	故障名称	故障处理方法及步骤
E-004	主电压过低	1、 检查输入电压是否正确, 确保输入电压稳定 2、 检查主轴电机工作是否正常
E-005	主电压过高	
E-007	IPM 过压或过流	
E-008	辅助设备电压 (24V) 过压异常	1、 检查线缆 L451 (控制箱 X16 接口线缆) 是否正确, 连接是否牢靠; 2、 分别检查切面线电机、切底线电机是否正常
E-009	辅助设备电压 (24V) 欠压异常	

















E-013	编码器故障或为连接	1、 检查主轴电机线缆（控制箱 X4、X5 接口线缆）是否正确，连接是否牢靠 2、 检查机械是否有卡住的现象，是否有卡点 3、 检查主轴电机是否正常
E-014	电机运行异常	
E-018	切刀位置异常	1、 检查机械安装是否正确，切刀是否能正常返回原点，遮光片能挡住传感器 2、 检查线缆 L438 是否正确，连接是否牢靠 3、 检查线缆 L453（控制箱 X9 接口线缆）是否正确，连接是否牢靠 4、 进输入检测模式，检查切刀传感器工作是否正常，遮挡时显示为“OFF”，不遮挡时为“ON” 5、 检查切刀电磁铁工作是否正常，连接线缆是否正确，通过参数 K05 可以更改切刀电磁铁工作电流，进入输出检测模式可以检查切刀电磁铁工作是否正常
E-037	切布刀不能返回	
E-038	切布刀传感器异常	
E-025	X 原点检测异常	1、 检查机械安装位置是否正确，检查传感器到安装是否正确，一般说来，传感器与遮挡片之间到距离应保持在 3mm 之内； 2、 检查摆针原点传感器线缆是否正确，连接是否牢靠 3、 检查线缆 L453（控制箱 X9 接口线缆）是否正确，连接是否牢靠； 4、 检查摆针电机转动是否正常，线缆是否正确（控制箱 X15 接口线缆），连接是否牢靠 5、 进输入检测模式，检查摆针原点传感器工作是否正常，摆针位置在左边时显示为“OFF”，在右边时显示为“ON”；从左到右或从右到左推动摆针，显示从“OFF”到“ON”或从“ON”到“OFF”只跳变一次，如有多次跳变，则表示安装位置不对，应进行适当到调整
E-026	Y 原点检测异常	1、 检查机械安装位置是否正确，检查传感器到安装是否正确，一般说来，传感器与遮挡片之间到距离应保持在 3mm 之内； 2、 检查送布原点检测传感器线缆是否正确，连接是否牢靠 3、 检查线缆 L453（控制箱 X9 接口线缆）是否正确，连接是否牢靠； 4、 检查送布电机转动是否正常，线缆是否正确（控制箱 X13 接口线缆），连接是否牢靠 5、 进入输入检测模式，检查送布原点传感器工作是否正常，用铁片挡住时显示为“ON”，不挡住时为“OFF”
E-027	压脚原点检测异常	1、 检查机械安装位置是否正确，检查传感器到安装是否正确，一般说来，传感器与遮挡片之间

		<p>到距离应保持在 3mm 之内；</p> <ol style="list-style-type: none"> <li>检查压脚原点传感器线缆是否正确，连接是否牢靠</li> <li>检查线缆 L453（控制箱 X9 接口线缆）是否正确，连接是否牢靠；</li> <li>检查压脚电机转动是否正常，线缆是否正确（控制箱 X12 接口线缆），连接是否牢靠</li> <li>进入输入检测模式，检查压脚原点传感器工作是否正常，用铁片挡住时显示为“ON”，不挡住时为“OFF”</li> </ol>
E-028	切面线原点检测异常	<ol style="list-style-type: none"> <li>检查机械安装位置是否正确，是否有卡点；检查传感器到安装是否正确，一般说来，传感器与遮挡片之间到距离应保持在 3mm 之内；</li> <li>检查切面线原点传感器是否正常，可进输入检测模式，用铁片遮挡该传感器，挡住时为 ON；</li> <li>检查线缆 L453（控制箱 X9 接口线缆）是否正确，连接是否牢靠；</li> <li>检查连接线缆 L451 是否正确，连接是否牢靠；</li> <li>检查马达转动是否正常，马达所接线缆是否正确，如马达有问题，则更换马达。</li> </ol>
E-035	切面线马达异常	
E-029	切底线原点检测异常	<ol style="list-style-type: none"> <li>检查机械安装位置是否正确，是否有卡点，检查传感器到安装是否正确，一般说来，传感器与遮挡片之间到距离应保持在 3mm 之内；</li> <li>检查切底线原点传感器是否正常，可进输入检测模式，用铁片遮挡该传感器，挡住时为“ON”，不遮挡时为“OFF”</li> <li>检查线缆 L453（控制箱 X9 接口线缆）是否正确，连接是否牢靠</li> <li>检查连接线缆 L451 是否正确，连接是否牢靠；</li> <li>检查马达转动是否正常，马达所接线缆是否正确，如马达有问题，则更换马达</li> </ol>
E-036	切底线马达异常	
E-030	步进驱动器通讯异常	<ol style="list-style-type: none"> <li>检查控制箱内线缆 C059-1 连接是否正确，连接是否牢靠</li> <li>检查步进驱动器软件是否正确</li> </ol> <p>注：系统在关电时某些时候也会报该错误，属于正常现象</p>
E-031	步进电机过流	<ol style="list-style-type: none"> <li>检查摆针电机、送布电机、抬压脚电机、切刀电磁铁是否正常，机械上是否顺畅</li> <li>重新上电后，如反复出现报该错误则须更换步进驱动板 MD301</li> </ol>
E-032	步进驱动电源异常	<ol style="list-style-type: none"> <li>检查控制箱内线缆 H079-1 是否正确，连接是否牢靠</li> <li>测量步进板 X12 接口电压是否正常，正常压值为 300V</li> </ol>
E-041	步进驱动版本错误	更换适用于本机的步进驱动板软件或步进驱动板















		MD301
E-044	机头板 EEROM 读写错误	1、 检查线缆 L453（控制箱 X9 接口线缆）是否正确，连接是否牢靠，如线缆有问题请更换该线缆。 2、 如线缆没有问题，则更换机头转接板 SC041
M-004	通讯错误	检查操作头与控制箱连接线缆（控制箱 X7 接口线缆）是否正确，连接是否牢靠
M-005	软件版本不一致	更换适用于本机的控制箱软件或操作头软件

## 10.4 形状初始值数据一览表

形状初始值数据一览表如下表所示。

序号	项目	单位															
S01	缝制形状	mm															
S02	切布长度	mm	12.7	12.7	12.7	12.7	12.7	12.7	12.7	12.7	12.7	12.7	12.7	12.7	12.7	12.7	12.7
S03	切刀槽右宽度	mm	0.10	0.10	0.10	0.10	0.10	0.10	0.10	0.10	0.10	0.10	0.10	0.10	0.10	0.10	0.10
S04	切刀槽左宽度	mm	0.10	0.10	0.10	0.10	0.10	0.10	0.10	0.10	0.10	0.10	0.10	0.10	0.10	0.10	0.10
S05	左包边宽度	mm	1.70	1.70	1.70	1.70	1.70	1.70	1.40	1.40	1.40	1.40	1.70	1.70	1.70	1.70	1.70
S06	左右形状比率	%	100	100	100	100	100	100	100	100	100	100	100	100	100	100	100
S07	平行部间隔	mm	0.35	0.35	0.35	0.35	0.35	0.35	0.35	0.35	0.35	0.35	0.35	0.35	0.35	0.35	0.35
S08	第二加固缝长度	mm	1.0	—	1.0	—	1.5	3.0	1.0	—	1.5	3.0	—	1.0	1.0	1.5	3.0
S09	第一加固缝长度	mm	1.0	—	—	—	—	—	—	—	—	—	—	—	—	—	—
S10	右加固宽度补偿	mm	0	—	0	—	0	—	0	—	0	—	—	0	0	0	—
S11	左加固宽度补偿	mm	0	—	0	—	0	—	0	—	0	—	—	0	0	0	—
S12	左锥形加固对称	mm	—	—	—	—	—	0.85	—	—	—	0.85	—	—	—	—	0.85
S13	右锥形加固对称	mm	—	—	—	—	—	0.85	—	—	—	0.85	—	—	—	—	0.85
S14	圆头扣眼形状长度	mm	—	—	—	—	—	—	2.0	2.0	2.0	2.0	—	—	—	—	—
S15	圆头扣眼针数	针	—	—	—	—	—	—	3	3	3	3	—	—	—	—	—
S16	圆头扣眼宽度	mm	—	—	—	—	—	—	1.0	1.0	1.0	1.0	—	—	—	—	—
S17	圆头扣眼长度	mm	—	—	—	—	—	—	3.0	3.0	3.0	3.0	—	—	—	—	—
S18	圆形形状长度	mm	—	2.0	2.0	2.0	2.0	2.0	—	2.0	—	—	2.0	2.0	2.0	2.0	2.0
S19	辐射形状针数	针	—	—	3	3	3	3	—	3	—	—	—	—	—	—	—
S20	辐射形状加固 有/无	—	—	—	无	无	无	无	—	无	—	—	—	—	—	—	—
S21	加固部分间隔	mm	0.30	0.30	0.30	-	0.30	0.30	0.30	-	0.30	0.30	0.25	0.30	0.25	0.25	0.25
S22	第 1 间隙	mm	1.5	1.5	1.5	1.5	1.5	1.5	1.5	1.5	1.5	1.5	1.5	1.5	1.5	1.5	1.5
S23	第 2 间隙	mm	1.3	1.3	1.3	1.3	1.3	1.3	1.3	1.3	1.3	1.3	1.3	1.3	1.3	1.3	1.3
S31	单/双重缝	—	单	单	单	单	单	单	单	单	单	单	单	单	单	单	单
S32	选择双重缝	—	<	<	<	<	<	<	<	<	<	<	<	<	<	<	<
S33	补偿双重缝宽度	mm	0	0	0	0	0	0	0	0	0	0	0	0	0	0	0
S34	下缝次数	次	0	0	0	0	0	0	0	0	0	0	0	0	0	0	0
S35	下缝速度	mm	4.0	4.0	4.0	4.0	4.0	4.0	4.0	4.0	4.0	4.0	4.0	4.0	4.0	4.0	4.0
S36	下缝卷入长度	mm	8.0	8.0	8.0	8.0	8.0	8.0	8.0	8.0	8.0	8.0	8.0	8.0	8.0	8.0	8.0
S37	下缝卷入间隙	mm	0.8	0.8	0.8	0.8	0.8	0.8	0.8	0.8	0.8	0.8	0.8	0.8	0.8	0.8	0.8
S38	下缝卷入宽度	mm	1.5	1.5	1.5	1.5	1.5	1.5	1.5	1.5	1.5	1.5	1.5	1.5	1.5	1.5	1.5
S39	补偿下缝落针前后	mm	1.5	1.5	1.5	1.5	1.5	1.5	1.5	1.5	1.5	1.5	1.5	1.5	1.5	1.5	1.5
S40	补偿下缝落针左右	mm	0	0	0	0	0	0	0	0	0	0	0	0	0	0	0
S41	补偿下缝左侧位置	mm	0	0	0	0	0	0	0	0	0	0	0	0	0	0	0
S42	补偿下缝右侧位置	mm	0	0	0	0	0	0	0	0	0	0	0	0	0	0	0
S44	下缝速度设定	mm	2000	2000	2000	2000	2000	2000	2000	2000	2000	2000	2000	2000	2000	2000	2000
S45	对缝功能 有/无	—	无	无	无	无	无	无	无	无	无	无	无	无	无	无	无
S46	对缝宽度	mm	2.0	2.0	2.0	2.0	2.0	2.0	2.0	2.0	2.0	2.0	2.0	2.0	2.0	2.0	2.0
S47	对缝间隙	mm	2.0	2.0	2.0	2.0	2.0	2.0	2.0	2.0	2.0	2.0	2.0	2.0	2.0	2.0	2.0

S51	左平行张力	—	60	60	60	60	60	60	60	60	60	60	60	60	60	60	60
S52	右平行张力	—	60	60	60	60	60	60	60	60	60	60	60	60	60	60	60
S53	左平行张力（双重缝的第一循环）	—	60	60	60	60	60	60	60	60	60	60	60	60	60	60	60
S54	右平行张力（双重缝的第一循环）	—	60	60	60	60	60	60	60	60	60	60	60	60	60	60	60
S55	第一加固部张力	—	35	60	120	35	35	35	60	60	60	60	60	60	60	60	60
S56	第二加固部张力	—	35	60	35	35	35	35	60	60	60	60	60	60	60	60	606
S57	设定缝制开始上线张力	—	25	25	25	25	25	25	25	25	25	25	25	25	25	25	25
S58	设定下缝上线张力	—	80	80	80	80	80	80	80	80	80	80	80	80	80	80	80
S59	开始第一加固缝，调整 AC 同步	针	0	0	0	0	0	0	0	0	0	0	0	0	0	0	0
S60	右包缝开始，ACT 同步调整	针	0	0	0	0	0	0	0	0	0	0	0	0	0	0	0
S61	开始第 2 加固缝，调整 AC 同步	针	0	0	0	0	0	0	0	0	0	0	0	0	0	0	0
S62	开始缝加固针数	针	3	3	3	3	3	3	3	3	3	3	3	3	3	3	3
S63	开始缝加固间隙	-	0	0	0	0	0	0	0	0	0	0	0	0	0	0	0
S64	开始缝宽度	mm	0.6	0.6	0.6	0.6	0.6	0.6	0.6	0.6	0.6	0.6	0.6	0.6	0.6	0.6	0.6
S65	开始缝加固竖向修正	mm	0	1.5	0	1.5	0	0	0	1.5	0	0	1.5	0	0	0	0
S66	开始缝加固横向修正	mm	0	0	0	0	0	0.7	0	0	0	0.7	0	0	0	0	0.7
S67	结束缝加固宽度	mm	0.6	0.6	0.6	0.6	0.6	0.6	0.6	0.6	0.6	0.6	0.6	0.6	0.6	0.6	0.6
S68	结束缝加固针数	针	3	3	3	3	3	3	3	3	3	3	3	3	3	3	3
S69	结束缝加固竖向修正	mm	0	0	0	0	0	0	0	0	0	0	0	0	0	0	0
S70	结束缝加固横向修正	mm	0.9	0.9	0.9	0.9	0	0.7	0.9	0.9	0	0.7	0.9	0.9	0.9	0	0.7
S81	切刀动作 有/无	—	有	有	有	有	有	有	有	有	有	有	有	有	有	有	有
S83	双重缝的第 1 循环切刀 有/无	—	无	无	无	无	无	无	无	无	无	无	无	无	无	无	无
S84	最高速度限制	rpm	3600	3600	3600	3600	3600	3600	3600	3600	3600	3600	3600	3600	3600	3600	3600
S86	前进前距	mm															
S87	前进宽度	mm															
S88	返回间距	mm															
S89	返回宽度	mm															

序号	项目	单位																
S01	Sewing shape	mm																
S02	切布长度	mm	12.7	12.7	12.7	12.7	12.7	12.7	12.7	12.7	12.7	12.7	12.7	12.7	13	19.1	19.1	19.1

S03	切刀槽右宽度	mm	0.10	0.10	0.10	0.10	0.10	0.10	0.10	0.10	0.10	0.10	0.10	—	—	0.10	0.10
S04	切刀槽左宽度	mm	0.10	0.10	0.10	0.10	0.10	0.10	0.10	0.10	0.10	0.10	0.10	—	0.10	—	0.10
S05	左包边宽度	mm	1.40	1.40	1.70	1.70	1.70	1.70	1.70	1.70	1.70	1.70	1.70	—	—	—	—
S06	左右形状比率	%	100	100	100	100	100	100	100	100	100	100	100	—	—	—	—
S07	平行部间隔	mm	0.35	0.35	0.35	0.35	0.35	0.35	0.35	0.35	0.35	0.35	0.35	—	—	—	—
S08	第二加固缝长度	mm	—	—	—	—	—	1.5	3.0	—	—	—	—	—	—	—	—
S09	第一加固缝长度	mm	—	—	1.0	1.0	1.0	1.0	1.0	—	—	—	—	—	—	—	—
S10	右加固宽度补偿	mm	—	—	0	0	0	0	0	—	—	—	—	—	—	—	—
S11	左加固宽度补偿	mm	—	—	0	0	0	0	0	—	—	—	—	—	—	—	—
S12	左锥形加固对称	mm	—	—	—	—	—	—	0.85	—	—	—	—	—	—	—	—
S13	右锥形加固对称	mm	—	—	—	—	—	—	0.85	—	—	—	—	—	—	—	—
S14	圆头扣眼长度	mm	2.0	2.0	—	—	—	—	—	—	—	—	—	—	—	—	—
S15	圆头扣眼针数	针	3	3	—	—	—	—	—	—	—	—	—	—	—	—	—
S16	圆头扣眼宽度	mm	1.0	1.0	—	—	—	—	—	—	—	—	—	—	—	—	—
S17	圆头扣眼宽度	mm	3.0	3.0	—	—	—	—	—	—	—	—	—	—	—	—	—
S18	圆形形状长度	mm	2.0	2.0	2.0	2.0	2.0	—	—	2.0	2.0	2.0	2.0	—	—	—	—
S19	辐射形状针数	Stitch	—	—	3	—	—	—	—	3	3	3	—	—	—	—	—
S20	辐射形状加固 有/无	—	—	—	无	—	—	—	—	无	无	无	—	—	—	—	—
S21	加固部分间隔	mm	0.25	0.30	0.30	0.25	0.30	0.30	0.30	0.25	0.30	0.25	0.25	—	—	—	—
S22	第 1 间隙	mm	1.5	1.5	1.5	1.5	1.5	1.5	1.5	1.5	1.5	1.5	1.5	—	2.0	2.0	2.0
S23	第 2 间隙	mm	1.3	1.3	1.3	1.3	1.3	1.3	1.3	1.3	1.3	1.3	1.3	—	2.0	2.0	2.0
S31	单/双重缝	—	单	单	单	单	单	单	单	单	单	单	单	—	—	—	单
S32	选择双重缝	—	<	<	<	<	<	<	<	<	<	<	<	—	—	—	<
S33	补偿双重缝宽度	mm	0	0	0	0	0	0	0	0	0	0	0	—	—	—	—
S34	下缝次数	次	0	0	0	0	0	0	0	0	0	0	0	3	2	2	—
S35	下缝速度	mm	4.0	4.0	4.0	4.0	4.0	4.0	4.0	4.0	4.0	4.0	4.0	4.0	4.0	4.0	—
S36	下缝卷入长度	mm	8.0	8.0	8.0	8.0	8.0	8.0	8.0	8.0	8.0	8.0	8.0	8.0	8.0	8.0	—
S37	下缝卷入间隙	mm	0.8	0.8	0.8	0.8	0.8	0.8	0.8	0.8	0.8	0.8	0.8	0.8	0.8	0.8	—
S38	下缝卷入宽度	mm	1.5	1.5	1.5	1.5	1.5	1.5	1.5	1.5	1.5	1.5	1.5	1.5	1.5	1.5	—
S39	补偿下缝落针前后	mm	1.5	1.5	1.5	1.5	1.5	1.5	1.5	1.5	1.5	1.5	1.5	1.5	1.5	1.5	—
S40	补偿下缝落针左右	mm	0	0	0	0	0	0	0	0	0	0	0	0	0	0	—
S41	补偿下缝左侧位置	mm	0	0	0	0	0	0	0	0	0	0	0	0	0	0	—
S42	补偿下缝右侧位置	mm	0	0	0	0	0	0	0	0	0	0	0	0	0	0	—
S44	下缝速度设定	mm	2000	2000	2000	2000	2000	2000	2000	2000	2000	2000	2000	2000	2000	2000	—
S45	对缝功能 有/无	—	无	无	无	无	无	无	无	无	无	无	—	—	—	—	—
S46	对缝宽度	mm	2.0	2.0	2.0	2.0	2.0	2.0	2.0	2.0	2.0	2.0	—	—	—	—	—
S47	对缝间隙	mm	2.0	2.0	2.0	2.0	2.0	2.0	2.0	2.0	2.0	2.0	—	—	—	—	—
S51	左平行张力	—	60	60	60	60	60	60	60	60	60	60	60	60	60	60	60
S52	右平行张力	—	60	60	60	60	60	60	60	60	60	60	60	60	60	60	60
S53	左平行张力（双重缝的第一循环）	—	60	60	60	60	60	60	60	60	60	60	60	—	—	—	—

S54	右平行张力（双重缝的第一循环）	—	60	60	60	60	60	60	60	60	60	60	60	60	—	—	—	—
S55	第一加固部张力	—	60	60	60	60	60	60	60	60	60	60	60	60	—	—	—	—
S56	第一加固部张力	—	60	60	60	60	60	60	60	60	60	60	60	60	—	—	—	—
S57	设定缝制开始上线张力	—	25	25	25	25	25	25	25	25	25	25	25	25	25	25	25	25
S58	设定下缝上线张力	—	80	80	80	80	80	80	80	80	80	80	80	80	80	80	80	80
S59	开始第一加固缝，调整 AC 同步	针	0	0	0	0	0	0	0	0	0	0	0	0	—	—	—	—
S60	右包缝开始，ACT 同步调整	针	0	0	0	0	0	0	0	0	0	0	0	0	0	0	0	0
S61	开始第 2 加固缝，调整 AC 同步	针	0	0	0	0	0	0	0	0	0	0	0	0	—	—	—	—
S62	开始缝加固针数	针	3	3	3	3	3	3	3	3	3	3	3	3	3	3	3	3
S63	开始缝加固间隙	-	0	0	0	0	0	0	0	0	0	0	0	0	0	0	0	0
S64	开始缝宽度	mm	0.6	0.6	0.6	0.6	0.6	0.6	0.6	0.6	0.6	0.6	0.6	0.6	0.6	0.6	0.6	0.6
S65	开始缝加固竖向修正	mm	1.5	1.5	1.5	1.5	1.5	0	0	1.5	1.5	1.5	1.5	1.5	0	0	0	0
S66	开始缝加固横向修正	mm	0	0	0	0	0	0	0.7	0	0	0	0	0	0	0	0	0
S67	结束缝加固宽度	mm	0.6	0.6	0.6	0.6	0.6	0.6	0.6	0.6	0.6	0.6	0.6	0.6	0.6	0.6	0.6	0.6
S68	结束缝加固针数	针	3	3	3	3	3	3	3	3	3	3	3	3	3	3	3	3
S69	结束缝加固竖向修正	mm	0	0	0	0	0	0	0	0	0	0	0	0	0	0	0	0
S70	结束缝加固横向修正	mm	0.9	0.9	0.9	0.9	0.9	0	0.7	0.9	0.9	0.9	0.9	0.9	0	0	0	0
S81	切刀动作 有/无	—	有	有	有	有	有	有	有	有	有	有	有	有	—	有	有	有
S83	双重缝的第 1 循环切刀 有/无	—	无	无	无	无	无	无	无	无	无	无	无	无	—	—	—	—
S84	最高速度限制	rpm	3600	3600	3600	3600	3600	3600	3600	3600	3600	3600	3600	3600	3600	3600	3600	3600
S86	前进前距	mm													0.80	0.80	0.80	0.80
S87	前进宽度	mm													1.7	1.7	1.7	1.7
S88	返回间距	mm													0.80	0.80	0.80	0.80
S89	返回宽度	mm													1.7	1.7	1.7	1.7

## 11 附录 2

### 11.1 电控箱安装尺寸

#### 1、SC500 电控箱安装尺寸图

本公司电控目前共有 2 种安装方式。分别为四孔安装方式、三孔安装方式。详细尺寸见下图。



图 1 四孔安装尺寸图



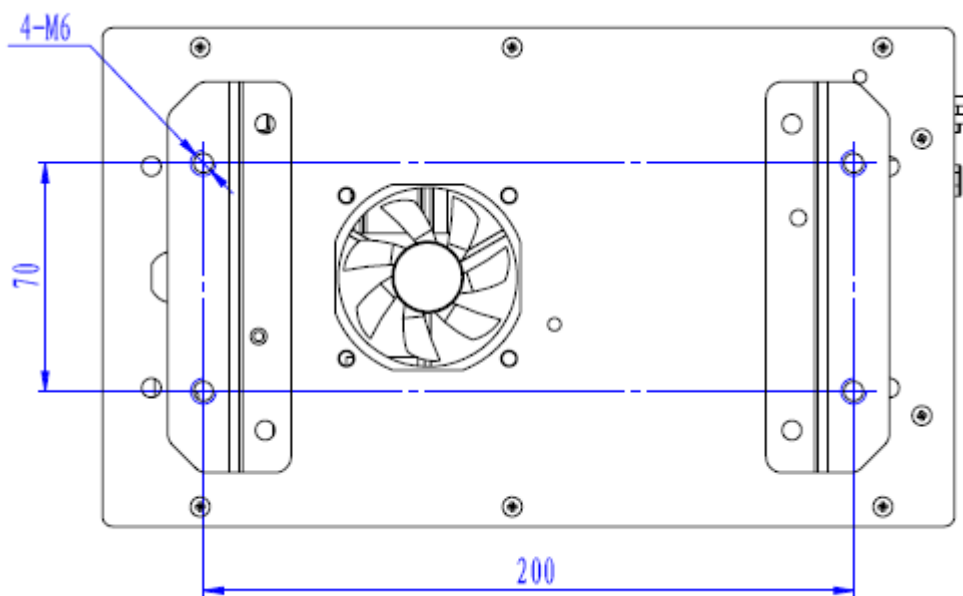

图 2 三孔安装尺寸图

2、MASC500 电控箱安装尺寸图

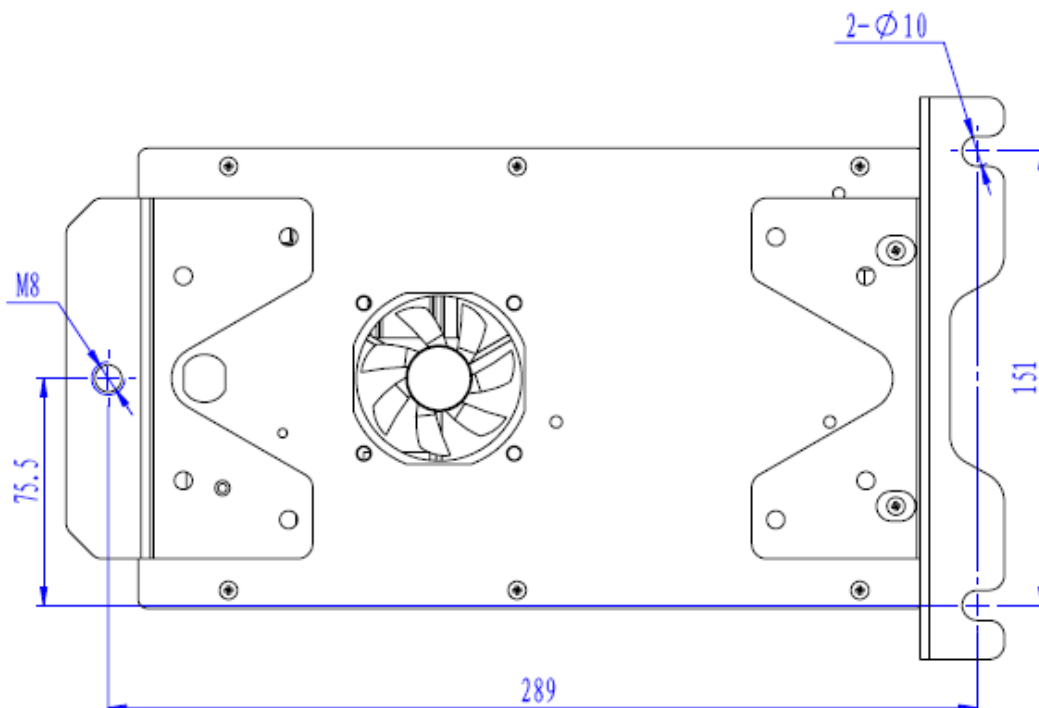
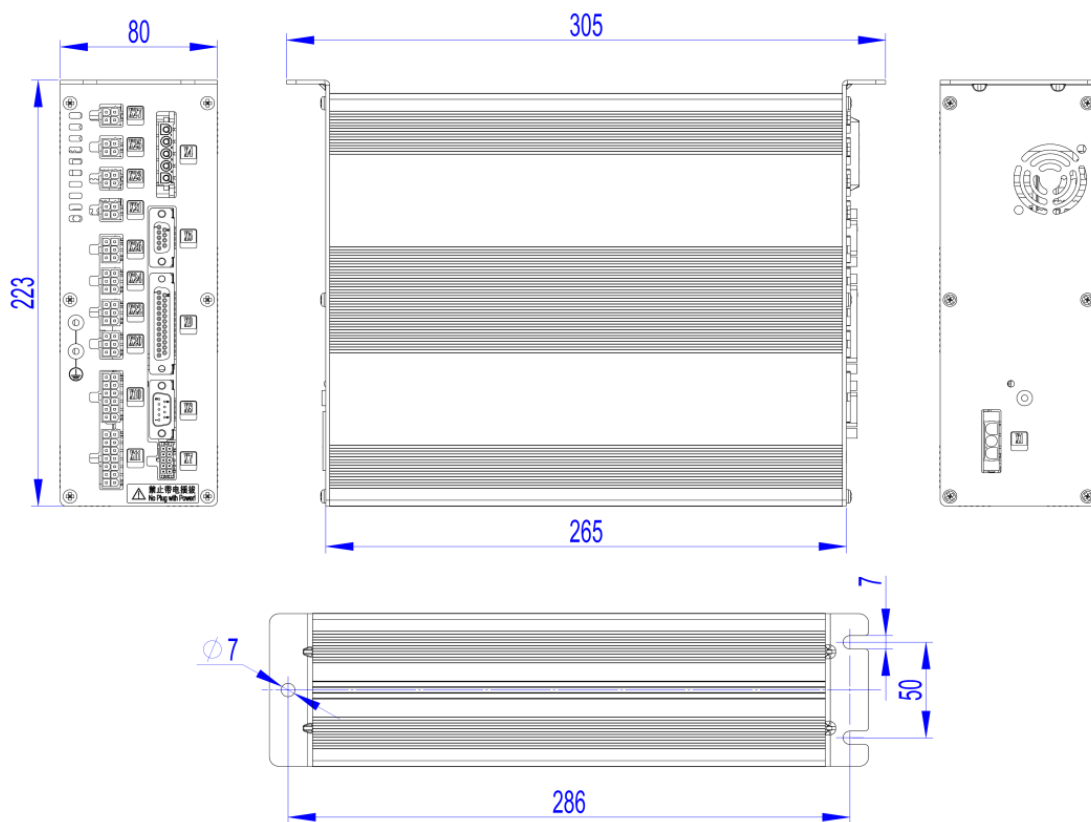

## 11.2 控制箱外部连接线缆

MASC500 电控箱后板接线图

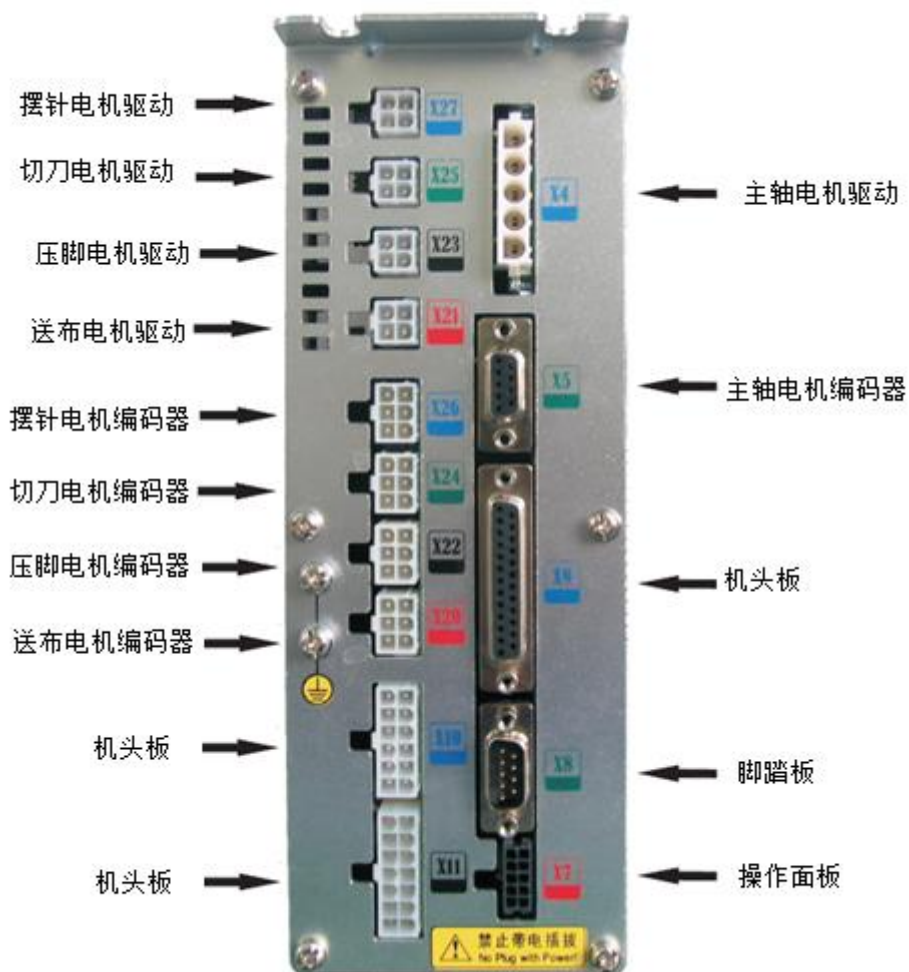

### 11.3 操作箱安装尺寸



图 3 操作箱安装尺寸图

# 11.4 系统框图

## 1、SC500-2E/X

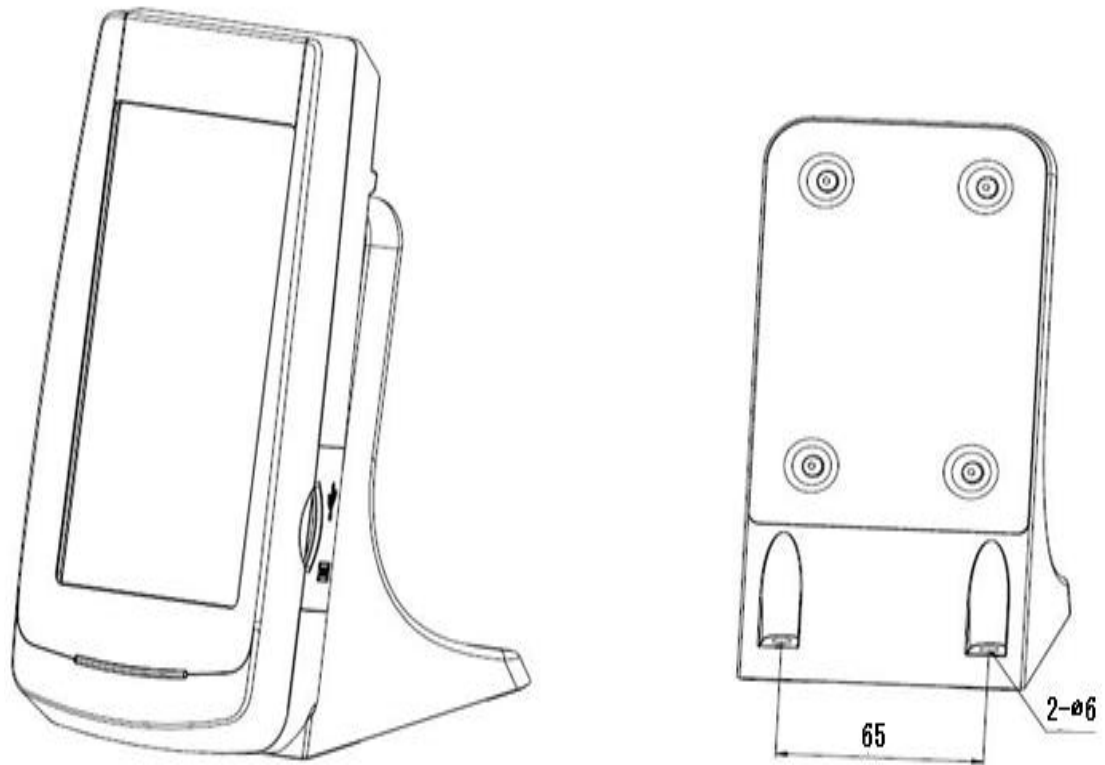
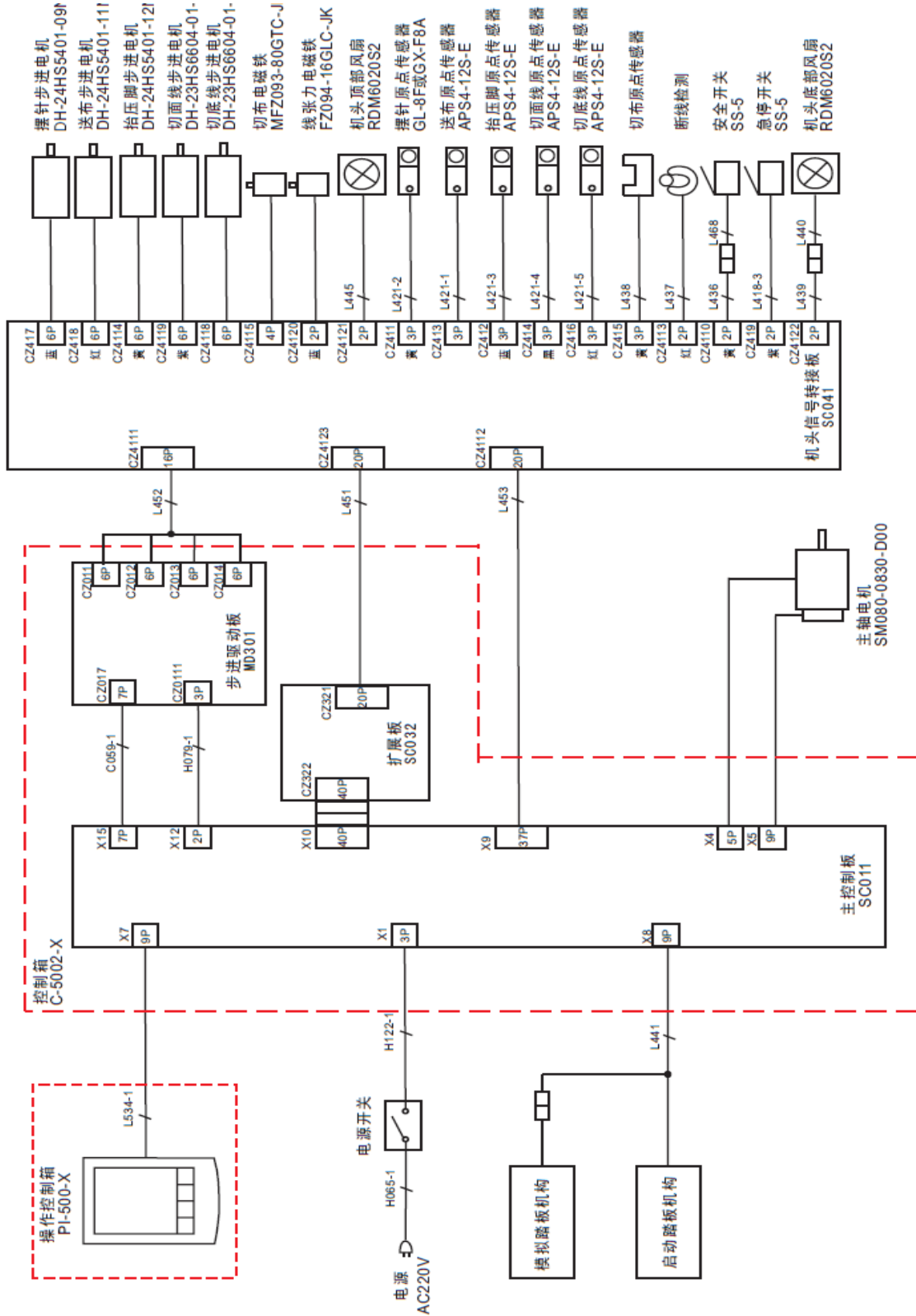

2、MASC500-2E/X

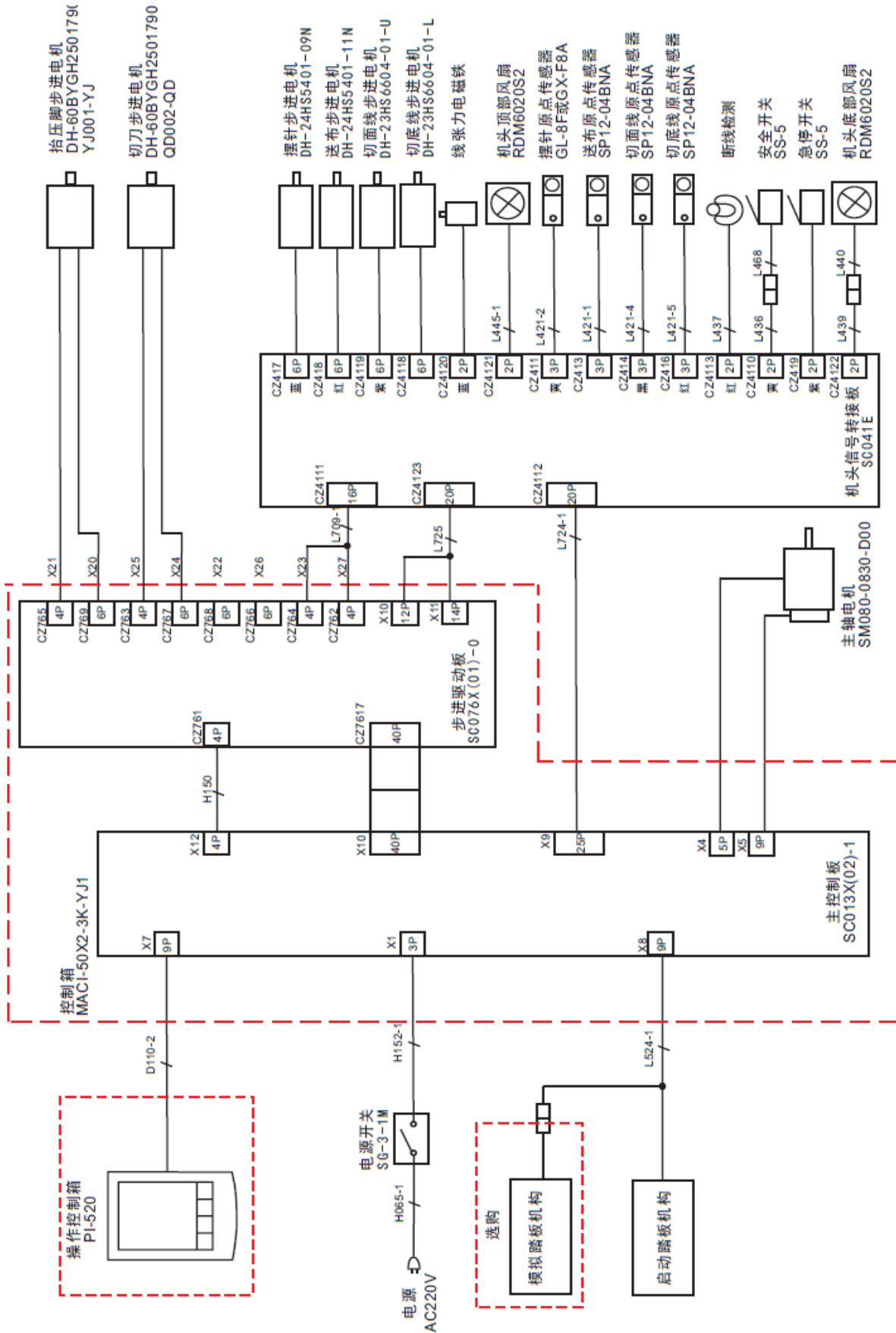

3、MASC500A-2E/X

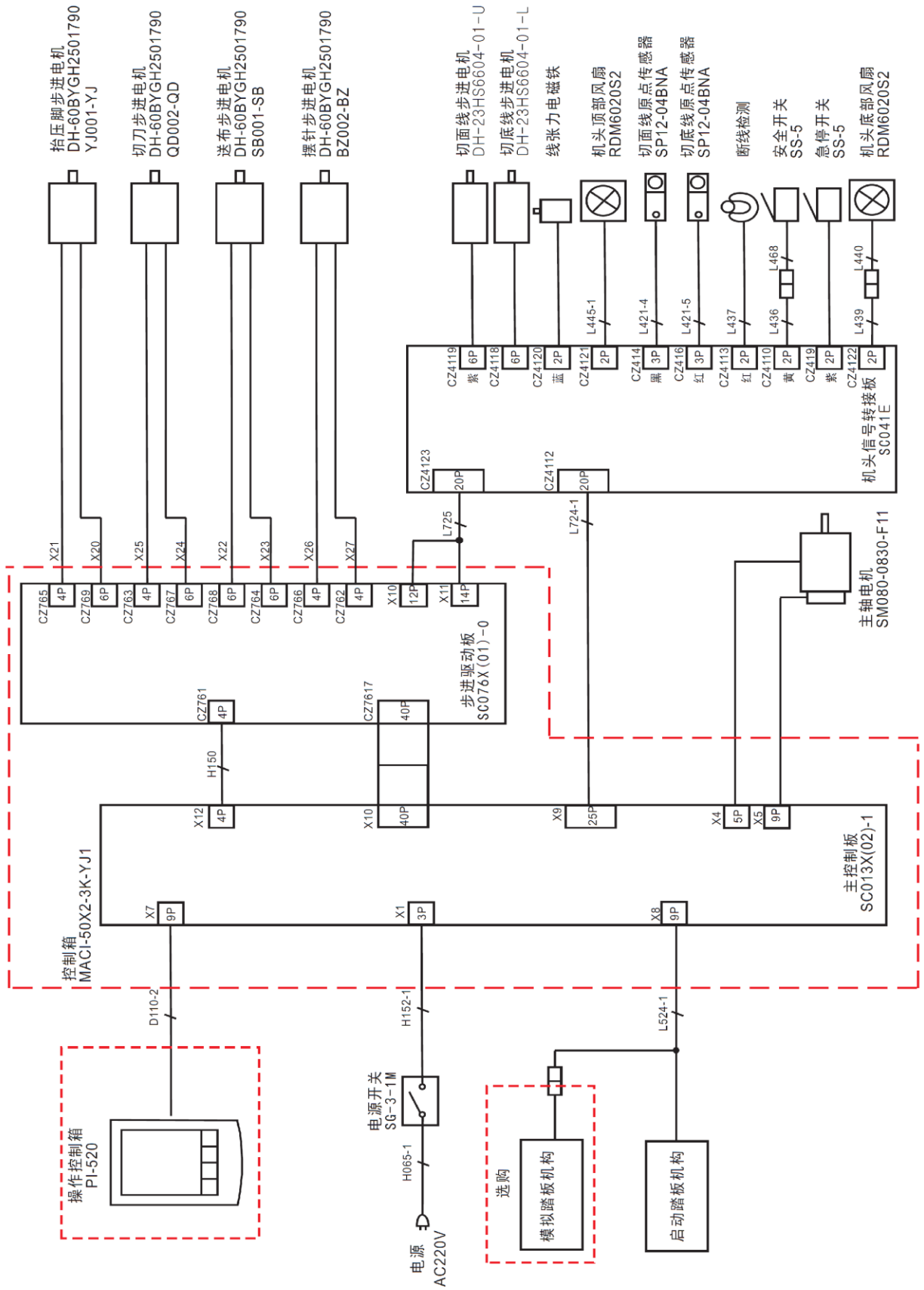

**Straight Buttonhole Machine  
-Touch Panel E**

# 1 General Information

## 1.1 General

This computerized control system for sewing machine features the following advantages: 1) Adoption of the world leading AC servo control technology on main shaft motor provides high torque, good efficiency, stable speed and low noise; 2) Diversified design of control panel can meet the special requirement of users on attachment; 3) System adopts German style structure, which offers easy installation and maintenance to users; 4) The system control software can be updated via the remote communication, which is easy for user to improve the performance of machine.

## 1.2 Function and Specification

For the functions and parameters of this computerized control AC servo system, please refer to table 1:

Table 1: Functions and Parameters

NO.	Name of Controller	High-speed Square Buttonhole Machine
1	Width	5mm (Min: 0.05mm)
2	Size of Knife (Length)	6.4~31.8mm (1/4"~1 1/4")
3	Sewing Length (Max)	41mm (The Max size is at 120mm with optional device)
4	Sewing Speed	Standard 3600rpm Max 4200rpm
5	Speed Control Method	Input via Control Panel
6	Needles	DP×5 # 11J ~ # 14J
7	Stroke of Needle Bar	34.6mm
8	Threading Bar	Chain-style Threading Bar
9	Shuttle	Type DP, All-auto Rotation Oil-supply Shuttle
10	Presser Height	14mm (Customized Setting) Max 17mm (At contrary rotation)
11	Presser Driving Device	Pulse Motor (1 pedal · 2 pedals)
12	Winding	Build-in Type (only winding at machine running)
13	Cloth-feeding Driving Device	Pulse Motor
14	Swing Needle Driving	Pulse Motor
15	Knife Driving Device	Two-way Solenoid
16	Upper-thread Tension Function	Solenoid Tension Method User can set the data at control panel to adjust each part (Parallel Part, Doubling Part Tension)
17	Stitch Form	Angle, Radial, Round (Selected at Control Panel) and other 30 types
18	Patterns in Memory	500 Patterns
19	Memory Media	U Disk



20	1/2 Shift	Can be set at every pattern
21	Motor	Small AC Servo Motor 400W Direct Driving
22	Size	Width 200mm、Height 360mm、Length 570mm
23	Head Weight	70Kg
24	Power	600W
25	Working Temperature	0°C ~45°C
26	Working Humidity	35%~85% (No Dew)
27	Voltage Input	AC 220V ±10%; 50/60Hz

## Presser Specification:

	Presser 1	Presser 2	Presser 3	Presser 5
Width	4mm	5mm	5mm	3-6mm(Set at will)
Sewing Length (Max)	25mm	35mm	41mm	10-120mm (Set at will)

Specification of Models S: Standard K: Knitting

※ Effective standard for product: QCYXDK0004—2016 《Computerized Control System for Industrial Sewing Machine》.

### 1.3 Standardization

The button using the common figure can be understood by the users from different countries.

### 1.4 Matters for Safe Using

#### ● Installation

- Control Box
  - ◆ Please install the control box according to the instruction
- Attachments
  - ◆ If other attachments are needed, please turn off the power and pull off the power plug.
- Power Cable
  - ◆ Do not press power cable with force or excessively twist power cable.
  - ◆ The power cables shall be fixed with a distance at 25mm away from the rotating component at least.
  - ◆ Before powering the control box, user shall carefully check the voltage of power supply and position of power input on control box. If the power transformer is used, user should also check it before powering the machine. At this moment, the power switch of sewing machine must be set as “Off”.
- Grounding
  - ◆ In order to avoid the noise disturbance and shock caused by electrical leakage, user should ground the grounding cable.
- Attachments

- ◆ If the electrical attachments are needed, please connect them to the proper positions.
- Disassemble
  - ◆ When removing the control box, user should turn off the power and pull off the power plug.
  - ◆ At pulling off the power plug, user should hold the plug and remove it, instead of pulling the power cable only.
  - ◆ The control box contains the dangerous high voltage power. For opening the control box, please turn off the power and take away the plug from socket firstly, and then wait for at least 5 minutes before opening the control box.

● **Maintenance, Inspection and Repair**

- Only can the trained technicians perform the repair and maintenance of this machine.
- When replacing the needles and shuttles, user has to turn off the power.
- Please use the spare parts from the authorized manufacturers

● **Others**



- Do not touch the rotating or moving part of the machine, especially the needle and belt, when the machine is working. User should also keep his/her hair away from those moving parts, so as to avoid the danger.
- Do not drop the control device on the floor, nor insert ant stuff into the slot on the control box.
- Do not run the machine without the cover shells
- If this control device is damaged or unable to work normally, please ask the technicians to adjust or repair it. Do not run the machine when the problem is not solved
- Please do not change or modify the control device without authorization

● **Abandonment**





- Dispose it as common industrial trash.

● **Warning and Danger**

- The mistake operation may cause danger. For the serious level, please refer to the figure at below:

	<b>Warning</b> The wrong operation may cause serious injury or death		<b>Caution</b> The wrong operation may cause personal injury or loss of property
---	---	---	---

- The meaning of the figure are shown at below:.

	Please operate machine according to instruction		Caution: High Voltage
	Caution: High Temperature		Grounding is a must
	Never do this.		

### 1.5 The Preventions on Instruction

## Warning

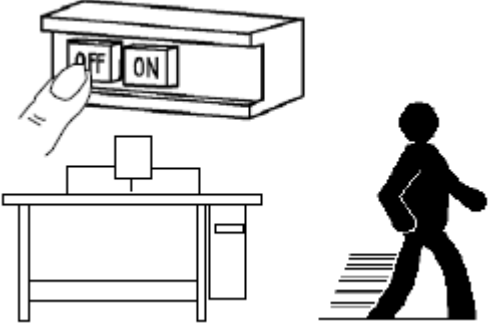
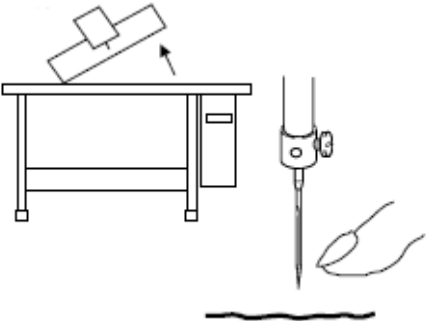
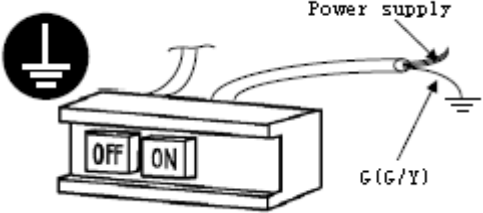
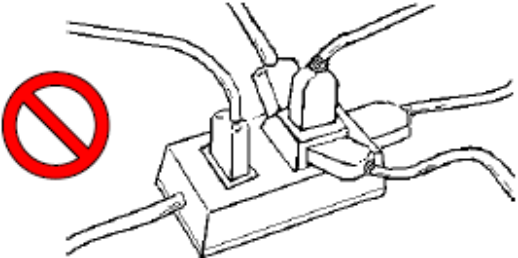
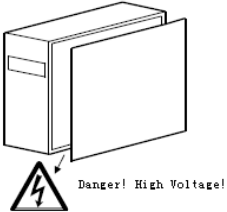
<p>1、 When you leave the machine, please turn it off.</p> 	
<p>3、 If user needs tilt the head or replace the needle or thread the Needle thread, please turn off the power</p> 	<p>4、 Grounding the machine with ground cable</p> 
<p>5、 Do not use the household terminal block to let machines to share one power supply</p> 	<p>6、 For opening the control box, please turn off the power and take away the plug from socket firstly, and then wait for at least 5 minutes before opening the control box</p> 
<p>8、 Please keep it away from the machine creating the high cyclic disturbance</p>	<p>9、 f user needs the external signal socket to connect the attachments, the connecting wire shall be as short as possible. The long cable may cause the wrong operation. And the connection cable shall be the isolated cable</p>

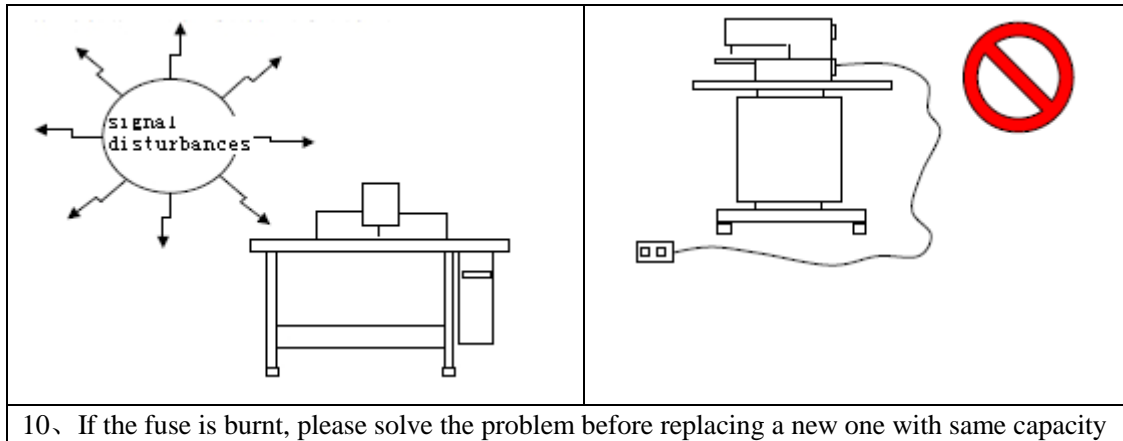

### 1.6 Operation Method

We use the advanced touching operation technique on the operation panel, whose friendly interface and simple operation will bring the big changes to users in their usage. Users can finish the relating operations by using their fingers or other object to touch the screen.

The function keys include Ready Key, Information Key, Mode Key and Communication Key. For the specific operation, please refer to the chapters at below:

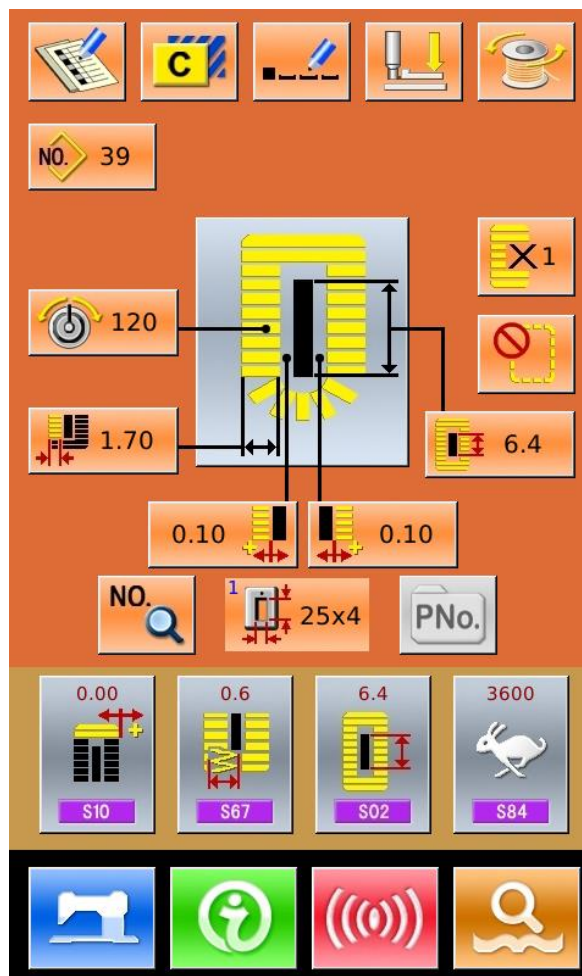































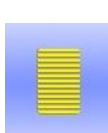

# Warning

Never use sharp object to touch the screen, otherwise the touching panel will suffer the permanent damage.

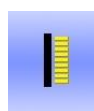
## 1.7 Sewing List

01 Square 	02 Round 	03 Radial Square 	04 Radial 	05 Radial Straight Bar-tacking 
06 Radial Taper Bar-tacking 	07 Eyelet Square 	08 Eyelet Radial 	09 Eyelet Straight Bar-tacking 	10 Eyelet Taper Bar-tacking 
11 Semi-lunar 	12 Round Square 	13 Semi-lunar Square 	14 Semi-lunar Straight Bar-tacking 	15 Semi-lunar Taper Bar-tacking 
16 Eyelet Semi-lunar 	17 Eyelet Round 	18 Square Radial 	19 Square Semi-lunar 	20 Square Round 
21 Square Straight Bar-tacking 	22 Square Taper Bar-tacking 	23 Radial Semi-lunar 	24 Radial Round 	25 Semi-lunar Radial 
26 Semi-lunar Round 	27 Bar-tacking 	28 Bar-tacking Right Cut 	29 Bar-tacking Left Cut 	30 Bar-tacking Center Cut 

## 2 Preparation before Sewing

### 2.1 Installation of Needle



Caution!

**In order to avoid the personal injury caused by the sudden start of machine, user has to turn off power and make sure the motor stops before performing the following operation**

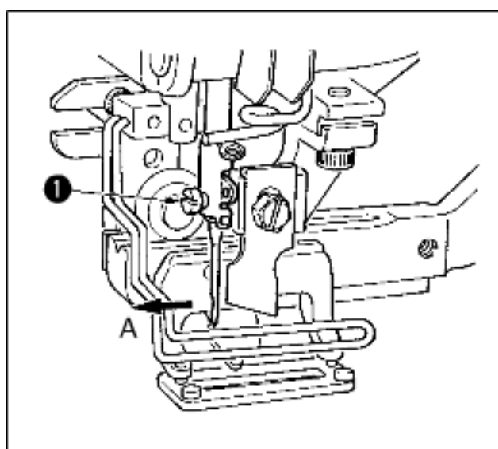

- 5) Turn the wheel to lift the needle to the highest position.
  - 6) Turn the slot on the needle to the front (in Direction A).
  - 7) Insert the needle into the needle bar hole deeply.
  - 8) Fix the needle screw ①
- ※ The needle should be DP×5 # 11J ~ # 14J

**Do turn off power when you install needles.**

### 2.2 Threading (Needle Thread)



Caution!

**In order to avoid the personal injury caused by the sudden start of machine, user has to turn off power and make sure the motor stops before performing the following operation**

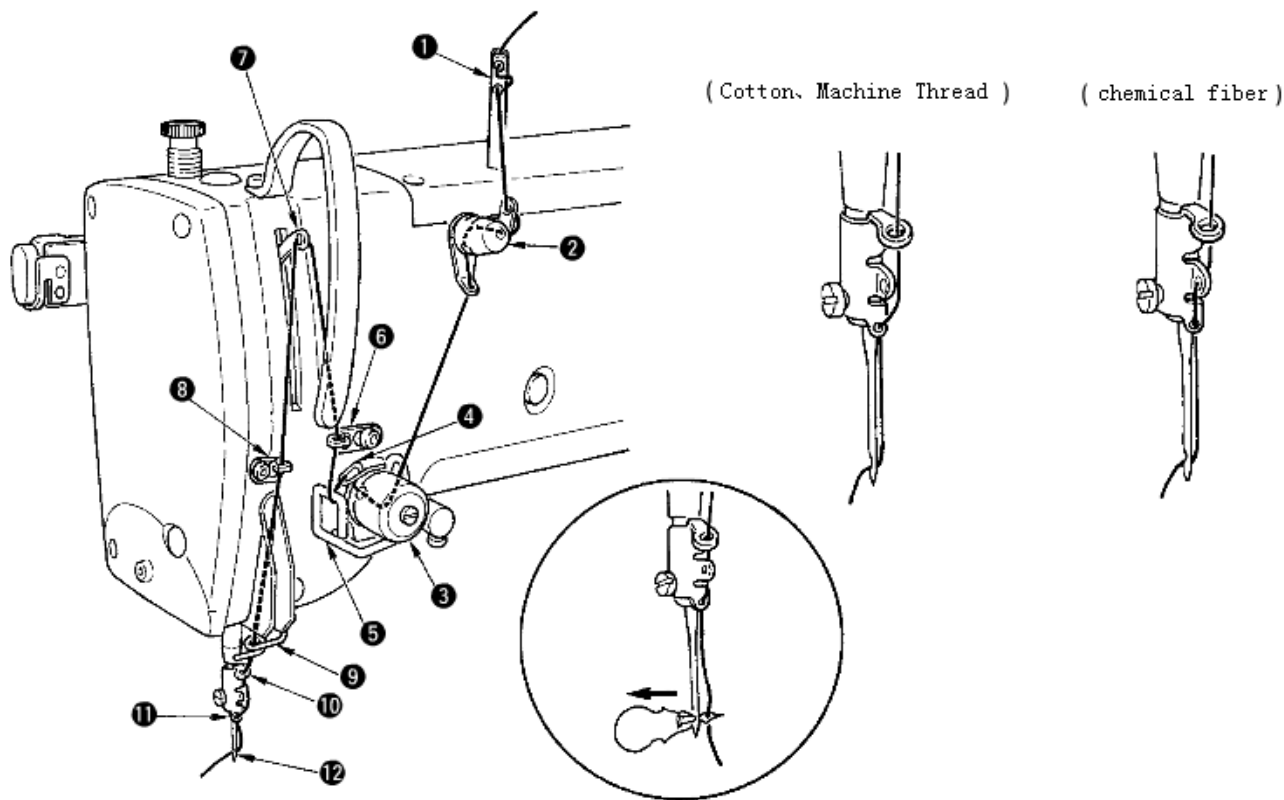

As shown in the picture above, please follow the steps from 1 to 12.

At threading, the threading device can help user to d this job in an easy and fast way.

### 2.3 Installation of Bobbin

 <p>Caution!</p>	<p><b>In order to avoid the personal injury caused by the sudden start of machine, user has to turn off power and make sure the motor stops before performing the following operation</b></p>
---	---

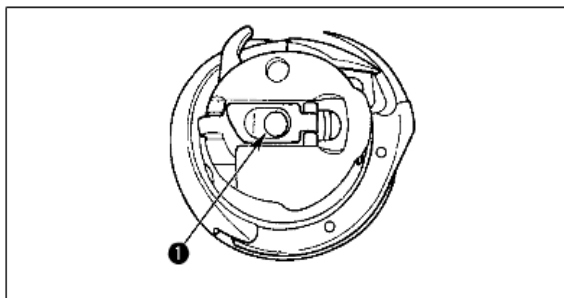

- ③ Erect the bobbin handle
- ④ Insert the bobbin shaft ① and close the handle. When the bobbin is pressed to the certain position, user will hear “Crack” at machine.
- ※ **If the bobbin is not in the proper position, the shuttle core will move at sewing and thread will be wound to shaft**
- ※ **The shape of standard shuttle is different from that of Non-oil shuttle. They cannot be used in common.**

## 2. 4 Threading at Bobbin

 <p>Caution!</p>	<p><b>In order to avoid the personal injury caused by the sudden start of machine, user has to turn off power and make sure the motor stops before performing the following operation</b></p>
---	---

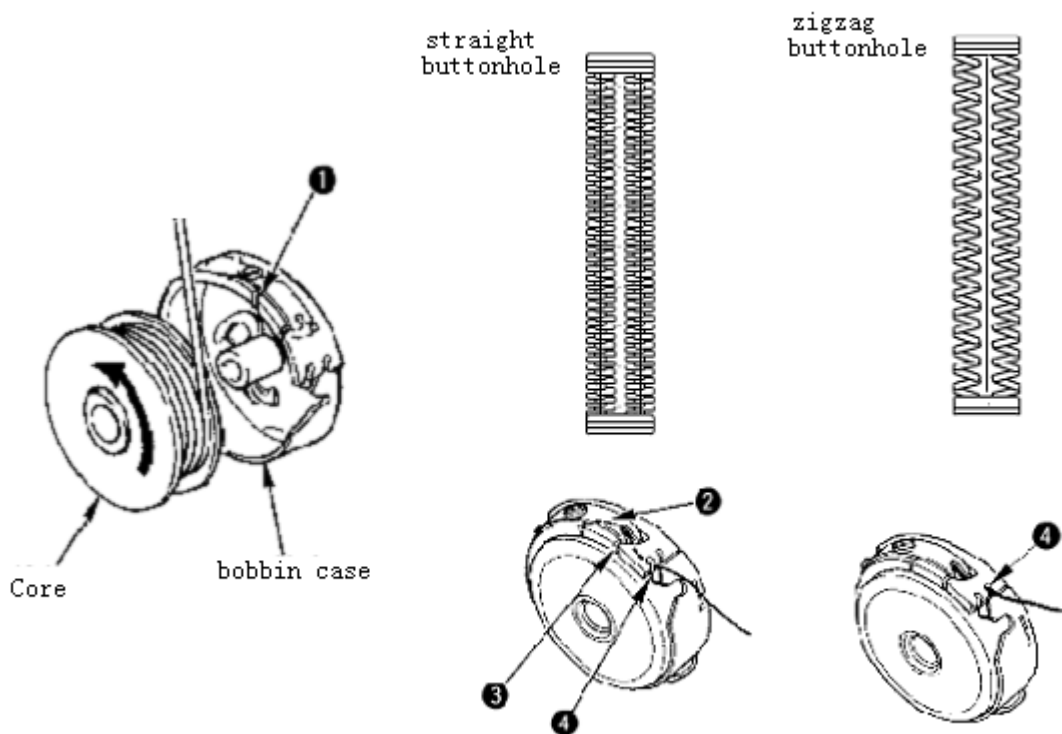

- 3) Install the shuttle core into the case in the direction of the arrow;
- 4) Thread the thread through the threading open ① and then pass the spring ②, then go through the open ③. Finally, pull the thread from the slot ④.

※ **Attention: The threading method at slot ④ in straight buttonhole sewing is different from that of zigzag buttonhole.**

## 2. 5 Adjustment of Bobbin Thread Tension

 <p>Caution!</p>	<p><b>In order to avoid the personal injury caused by the sudden start of machine, user has to turn off power and make sure the motor stops before performing the following operation</b></p>
---	---



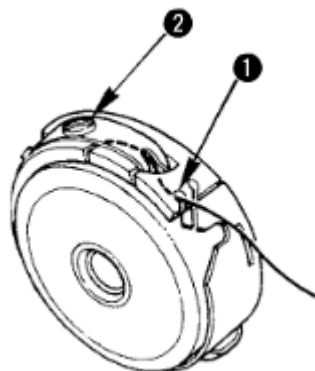

When the threading open ① is at up position, user need pull out the bobbin thread upward and adjust the tension in the way below:

Straight Buttonhole	0.05~0.15N	Hold and swing the thread from bobbin case, the case will go down slightly.
Zigzag Buttonhole	0.15~0.3N	Hold and shake the thread from bobbin case with strength, the case will go down.

Turn the tension screw ② to right to increase the bobbin thread tension, to left to decrease the tension.

※ When the chemical thread is used, please decrease the tension slightly; increase the tension when the cotton thread is used.

※ After adjusting the bobbin thread tension, user also needs to check the needle thread tension in the sewing parameters.

## 2.6 Installation of Knife

	<b>Caution!</b> <b>In order to avoid the personal injury caused by the sudden start of machine, user has to turn off power and make sure the motor stops before performing the following operation</b>
---	---

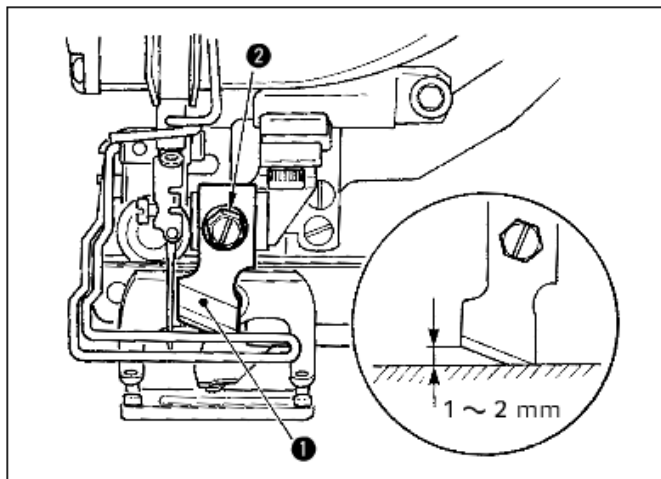

- 3) Remove the knife screw ② to disassemble the knife ① and shim.
- 4) Press the knife and adjust the distance from the knife to the needle plate to 1~2mm as shown in the picture at above. Then install the shim and fix the screw.

If the size of the knife is printed in British size, please refer to the table at below:

**Size of Knife (displayed in British size and relating metric size)**

Size of Knife (British size)	Size of Knife (metric size) mm
1/4	6.40
3/8	9.50
7/16	11.10
1/2	12.70
9/16	14.30
5/8	15.90
11/16	17.50
3/4	19.10
13/16	20.60
7/8	22.20
1	25.40
1 1/8	28.60
1 1/4	31.80
1 3/8	34.90
1 1/2	38.10

## 2.7 Method for Adding Oil



Caution!

**In order to avoid the personal injury caused by the sudden start of machine, user has to turn off power and make sure the motor stops before performing the following operation**

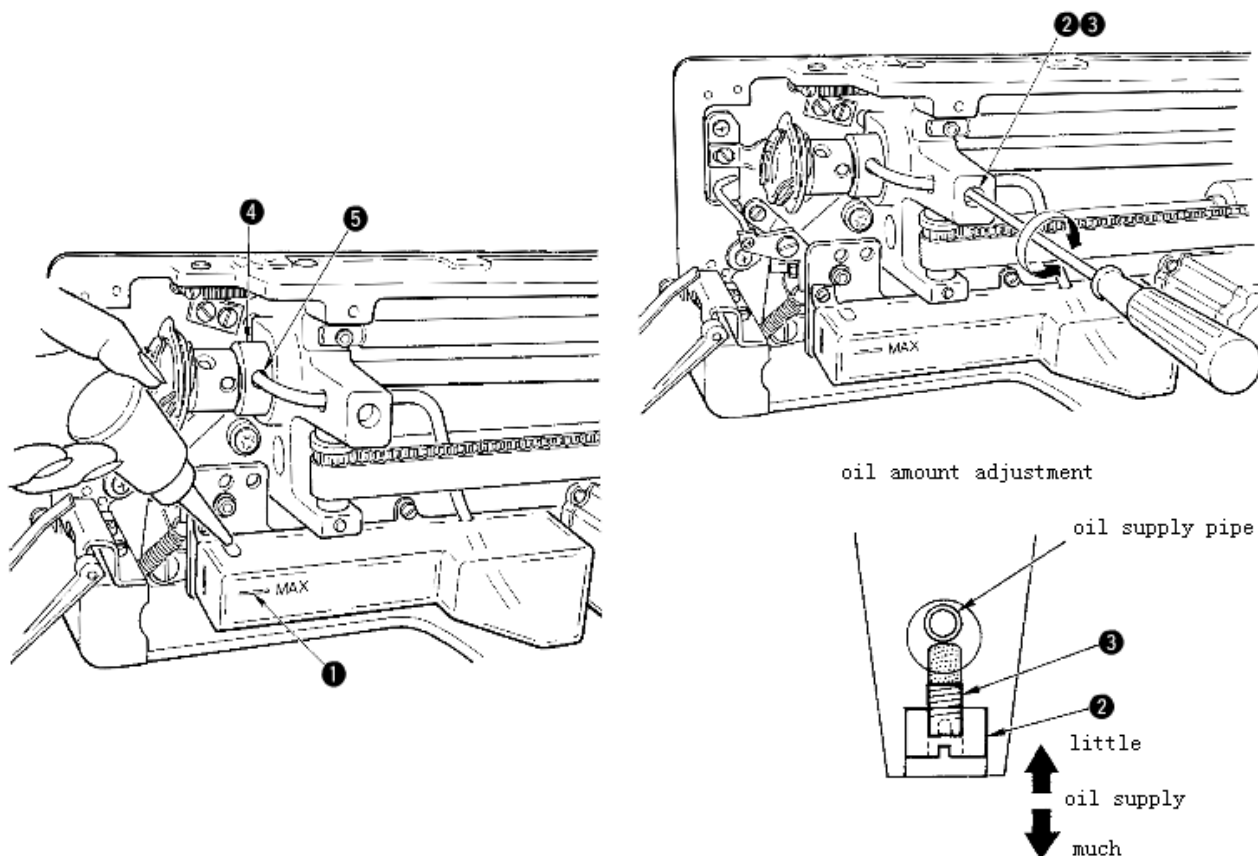

### 3) Add oil to tank

- Add oil until the oil surface reach the mark of MAX ①.

### 4) Adjustment of Oil Amount

- Release the fixing screw ② and adjust the Oil Adjustment Screw ③.
- At adjusting the oil amount, fix the Oil Adjustment Screw ③ to decrease the oil amount.
- After adjusting the oil amount, please fix the screw ②.
- If the sewing machine is a new one or left unused for long time, please disassemble the bobbin case and add oil for 2~3 drops. Additionally, add oil to the metal part ④ through the oiling hole ⑤ with several drops to wet the felt inside.

# 3 Operating Instruction

## 3.1 Name and Description of Each Part

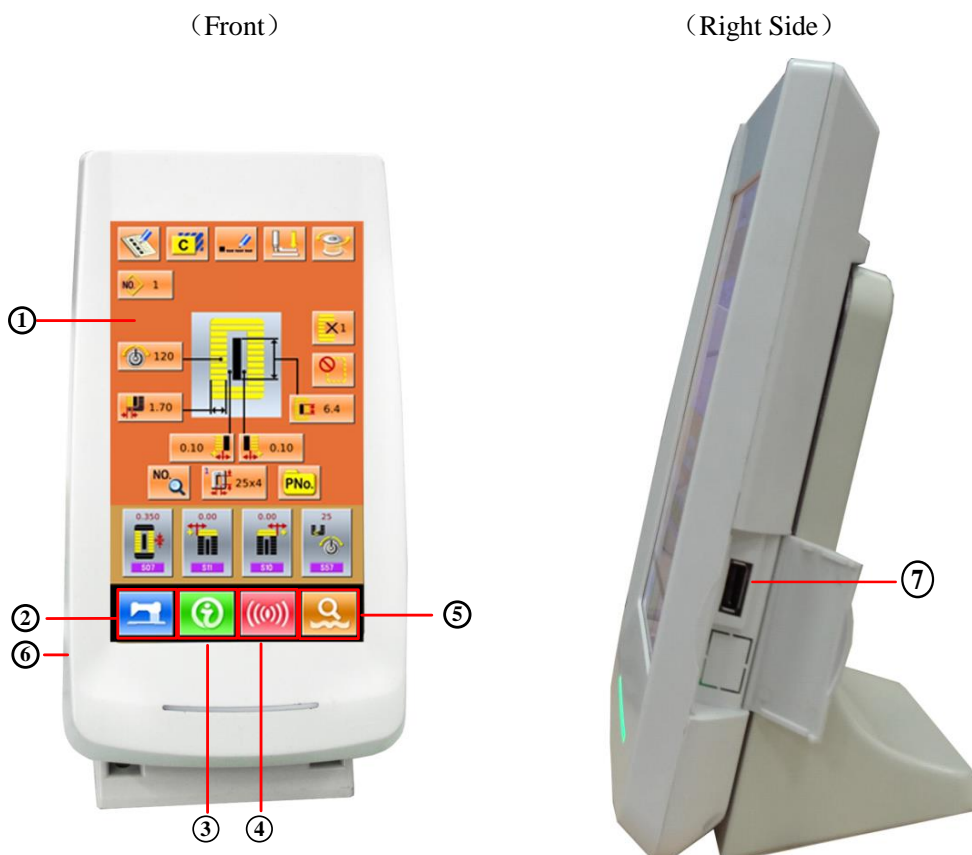

① Touch Panel • LCD Displayer

②  READY Key → Shift between the data input interface and sewing interface

③  Information Key → Shift between the data input interface and information interface

④  Communication Key → Shift between the data input interface and communication interface

⑤  Mode Key → Shift between the data input interface and communication interface 模

⑥ Cable

⑦ USB Port

### 3.2 Common Buttons

The buttons for the common operation in each interface are shown at below:

No.	Figure	Functions	Remarks
1		ESC → Quit the current interface. At data change interface, it is for cancelling the change of data.	
2		Enter → Confirm the changed data.	
3		Plus → Increase the value	
4		Minus → Decrease the value	
5		Reset → Release the Error	
6		Number Input → Display the number keyboard and input the number.	

### 3.3 Basic Operation

① Turn on the power

First, make sure that the set presser type (A) is the same as that of the presser actually installed.

② Select the wanted pattern No.

When the power is on, the data input screen is displayed. Pattern No. (Button B) which is marked at present is displayed in the upper section of the screen. Press Button B to select the pattern No. (The unregistered Pattern No. will not be displayed)

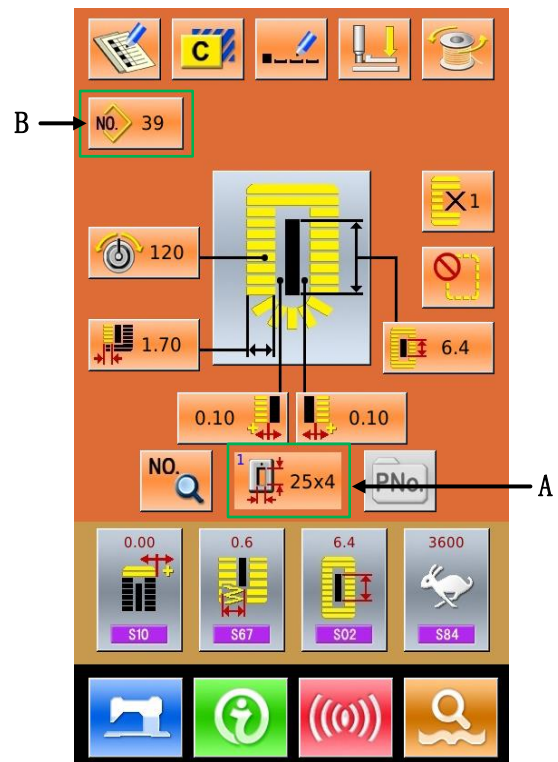

⑤ **Set machine to Ready Sewing Status**

Press READY key . The back-light of LCD displayer changes to blue color and the machine is ready for sewing. Area A is to set the speed and Area B is to display the customer management.

⑥ **Start sewing**

Set the sewing product to the presser position; operate the pedal to start the sewing machine, and sewing starts.

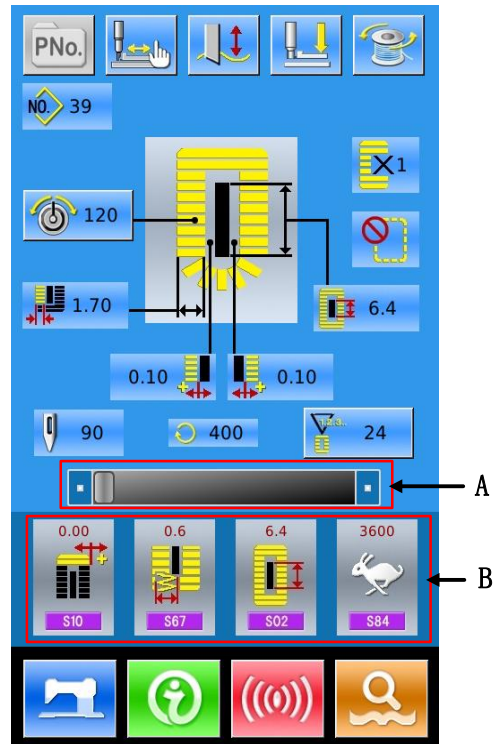

### 3. 4 Operation of Normal Pattern

The interface for setting and sewing the normal pattern is shown at right. For the function of each button, please refer to “4. Normal Pattern Sewing”.

The normal sewing is the default sewing mode in the system, which is also the initial mode of the system.



Steps of Operation:

- ⑬ Press  to enter the Mode Setting



⑭ Press  to select the normal sewing mode



⑮ Press  and then press  to display the main interface of Normal Sewing

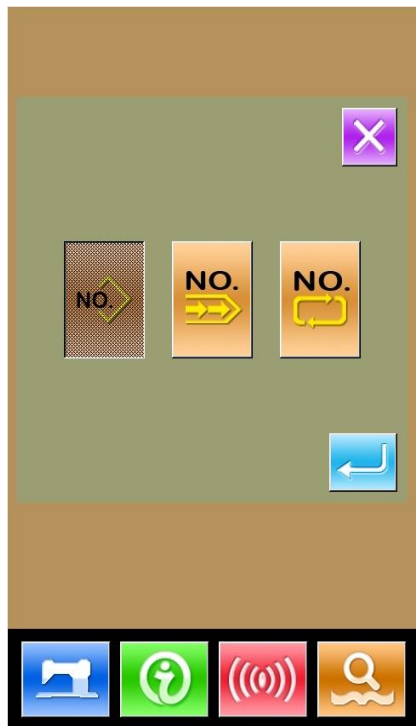

- ⑯ Select the sewing pattern
- ⑰ Set the necessary sewing parameter
- ⑱ Select the presser type
- ⑲ Perform the necessary editing operation (Registration, copy, naming and so on)

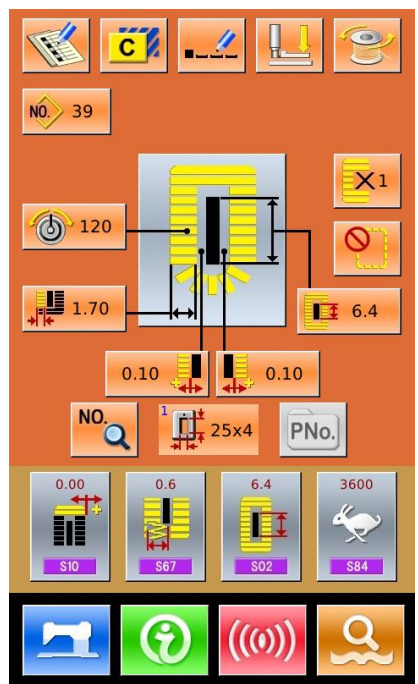

- ⑳ Press  to enter the sewing interface for sewing
- ㉑ Set knife and speed at sewing interface
- ㉒ Set the counter
- ㉓ Select the Trial Sewing if necessary
- ㉔ Drop the presser, step the pedal and start sewing

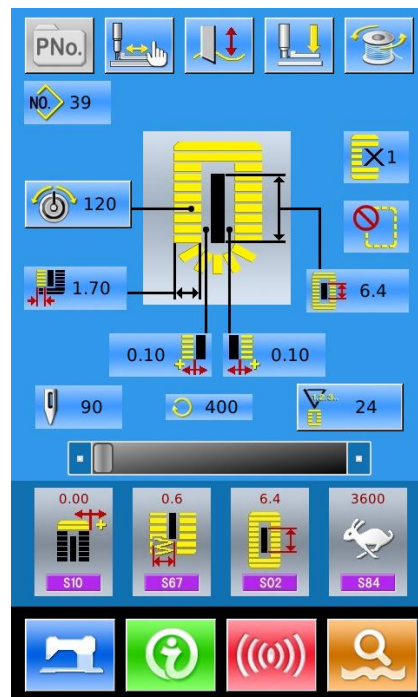

### 3.5 Operation of Continuous Sewing

The interface for the continuous sewing is shown at right. For the function of each button, please refer to “5. Continuous Pattern Sewing”.



Operation Steps:

- ㉑ Press  to enter the Mode Setting





⑫ Press  then select 

⑬ Press  and then press  to display the main interface of continuous sewing

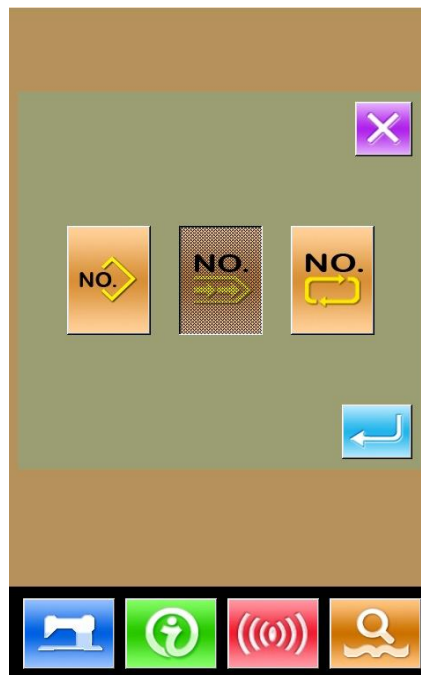

⑭ In the main interface of continuous sewing, please add the pattern used and the cloth-feeding amount.

⑮ Perform the necessary editing operations (Copy, Naming, Adding and Deletion)

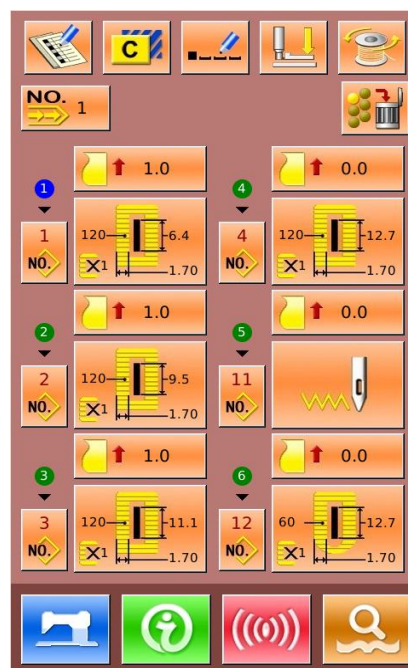

- ⑩ Press  to enter the sewing interface for sewing
- ⑪ Set knife and speed at sewing interface
- ⑫ Set the counter
- ⑬ Select the Trial Sewing if necessary
- ⑭ Drop the presser, step the pedal and start sewing

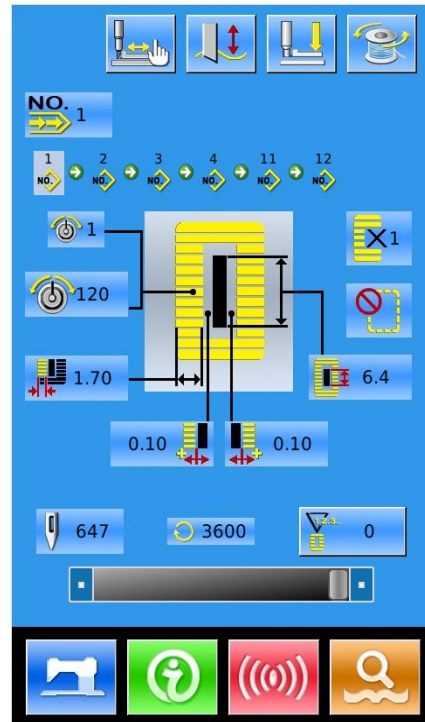





### 3.6 Operation of Cyclic Sewing

The interface for the cyclic sewing is shown at right. For the function of each button, please refer to “6. Cyclic Pattern Sewing”.

Operation Steps:

- ⑬ Press  to enter the Mode Setting



- ⑭ Press  then select 
- ⑮ Press  and then press  to display the main interface of cyclic sewing

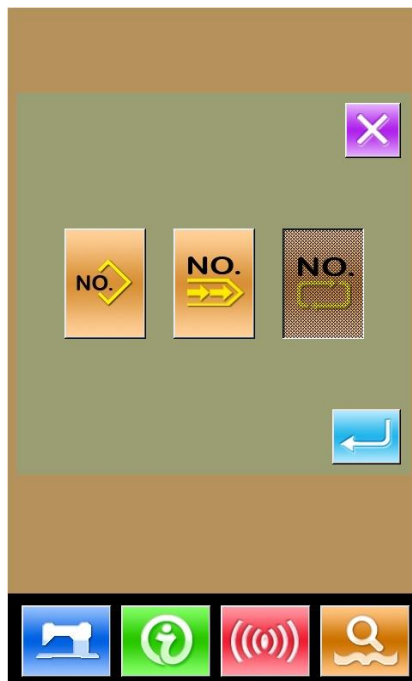

- ⑯ In the main interface of cyclic sewing, please select the fabric
- ⑰ Move the sewing position and add the pattern for cyclic sewing
- ⑱ Set the parameter of the pattern
- ⑲ Perform the necessary editing operations (Copy, Naming, Adding and Deletion)



- ⑳ Press  to enter the sewing interface for sewing
- 21 Set knife, tension and speed at sewing interface
- 22 Set the counter
- 23 Select the Trial Sewing if necessary
- 24 Drop the presser, step the pedal and start sewing

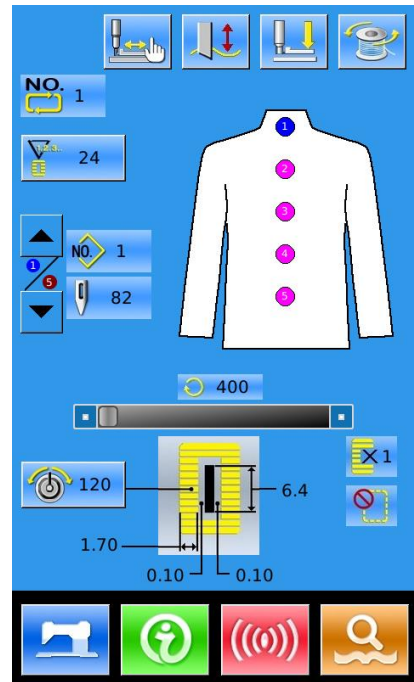

# 4 Normal Pattern Sewing

When the system is sold, the default mode in it is the normal pattern sewing mode. The operation steps of it are described in “3. Operation Instruction”. In this chapter, we will give the detailed description on this mode.

## 4.1 Function Keys





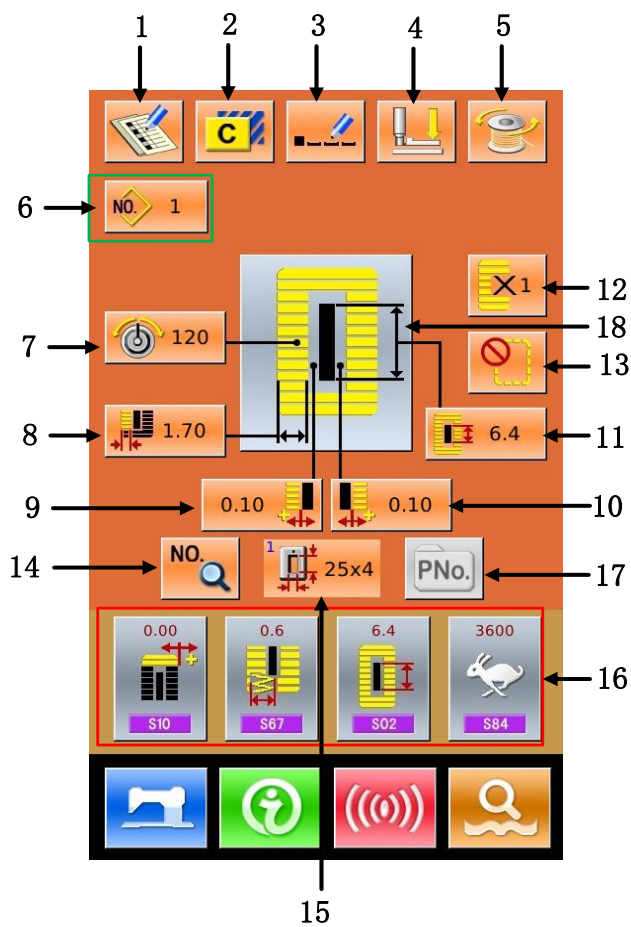







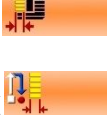

### (1) Interface for Inputting Sewing Data

The interface of data input is shown as the Figure at right. For the detailed functions, please take the Function Key List for reference.



Function Key List:

No.	Figure	Function	Remarks
1		Pattern Registration	
2		Pattern Copy	
3		Pattern Naming	

No.	Figure	Function	Remarks
4		Threading (Lower the presser foot )	User can change needle in this status
5		Winding	
6		Pattern No. Selection	Pressing this button can enter the pattern selection interface
7		Set Upper-Thread Tension (S51, S52, S55, S56)	S52 and S56 will be influenced by the data switch of sewing.
8		Set/Return to Left Over-edging Width	For the pattern from No.1~ No.26, this button means to set left over-edging width; while for the patterns from No.27~ No.30, this button means to return to the Width Setting
9		Set Left Width of Knife Groove	Unavailable for Pattern No.27 &No.29
10		Set Right Width of Knife Groove	Unavailable for Pattern No.27 &No.28
11		Length of Cloth Cutting	
12		Set Double Stitching or Single Stitching	Unavailable for Pattern No.27, No.28&No.29
13		Set Numbers of Basting	Unavailable for Pattern No. 30
14		Set Sewing Data	
15		Select Type of Presser foot	
16		Customer Management	Set 4 buttons on the main interface for the 4 most frequently used sewing data groups
17		Directly Select Pattern by Number	
18		Sewing Pattern Selection	

(2) Interface of Sewing

Press  to enter the Sewing Interface shown as the figure at right. For detailed functions please take the Function Key List for reference.

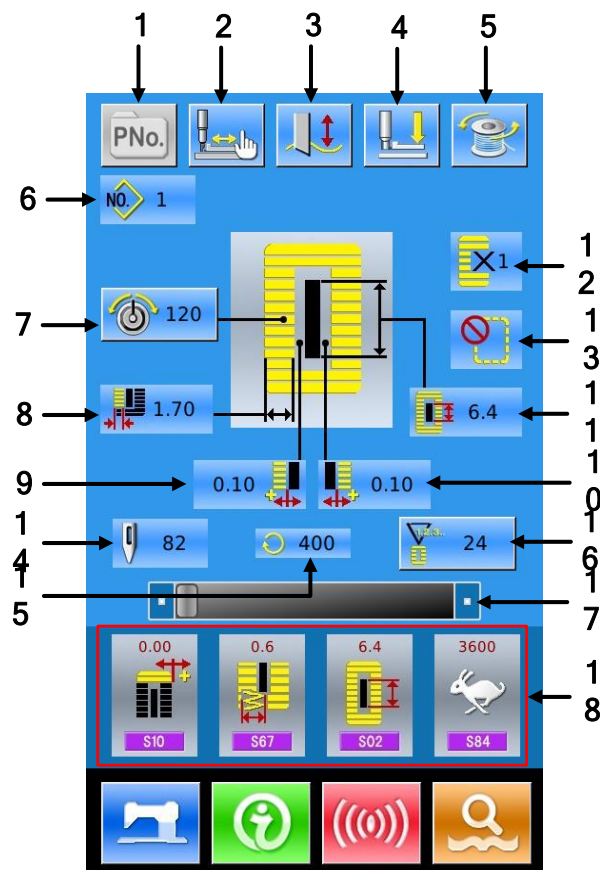

Function Key List:

No.	Figure	Function	Remarks
1		P Pattern Selection Key	Controlled by Parameter k18
2		Trial sewing	
3		 : Knife Available  : Knife Unavailable	Shift Knife Status
4		Threading (Lower the presser)	
5		Winding	
6		Pattern No. Display	
7		Upper-thread Tension Setting	
8		Left Over-edging Width	

No.	Figure	Function	Remarks
9		Left Width of Knife Groove	
10		Right Width of Knife Groove	
11		Length of Cloth Cutting	
12		Single Stitching/ Double Stitching	
13		Numbers of Basting	
14		Total Number of Stitches	
15		Current Sewing Speed	
16		Counter Value  : Sewing Counter : No. of piece counter	
17		Speed Setting	Controlled by Parameter k07
18		Customer Management	

## 4. 2 Pattern Registration

500 normal patterns can be registered for the most.

press to enter the interface of Pattern Registration (shown as the right figure):

### ② Input Pattern No.

Input the pattern No. via keyboard. If the pattern number is already existed in the system, the look and relevant information of the registered pattern will be shown on the upper interface. The used

number can't be reused, but by pressing ,

the unregistered number can be searched.

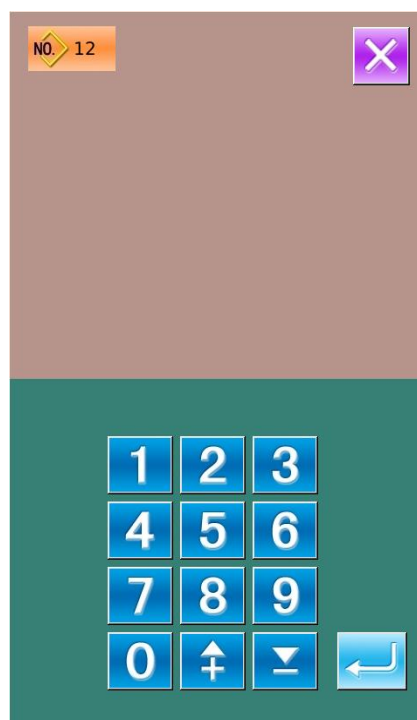



③ Select the 1st bar-tacking Sewing shape

After setting the pattern number, user can press  to enter the interface for selecting the 1st bar-tacking sewing shape (as shown in right figure).

Press  to quit the selection.

**Note: The Number of Sewing Shape is controlled by the parameter K04. Please refer to the Section 4.9 Sewing Shape Selection.**



④ Finish the Selection

After user selects the 1st bar-tacking shape, the system will enter the interface of selecting the finish shape (as shown in the right figure).

Press  to finish the registration of new pattern and return to the main interface. According to the selected shape for sewing, user can set the initial value of sewing data

Press  to quit the selection

**Note: The Number of Sewing Shape is controlled by the parameter K04. Please refer to the Section 4.9 Sewing Shape Selection.**

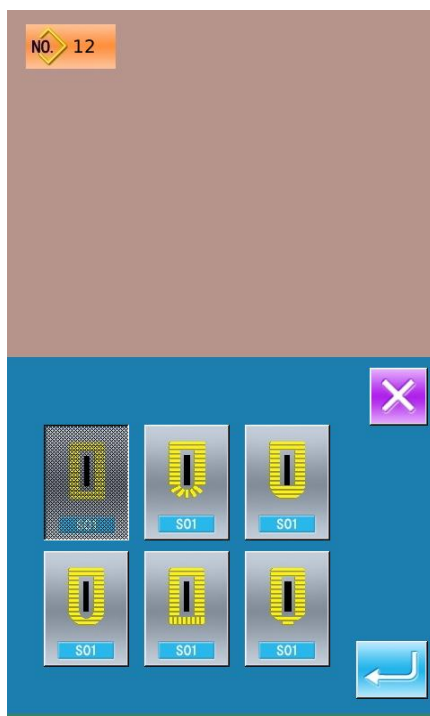

### 4.3 Pattern Copy

#### ① Select the target pattern

Press  to enter the interface for copying the pattern (as shown in right figure).

A、Among the registered patterns, select the pattern number of the copied one and press . Then the system will enter the interface for inputting the registration number.

B、Press  to quit the pattern copy interface directly

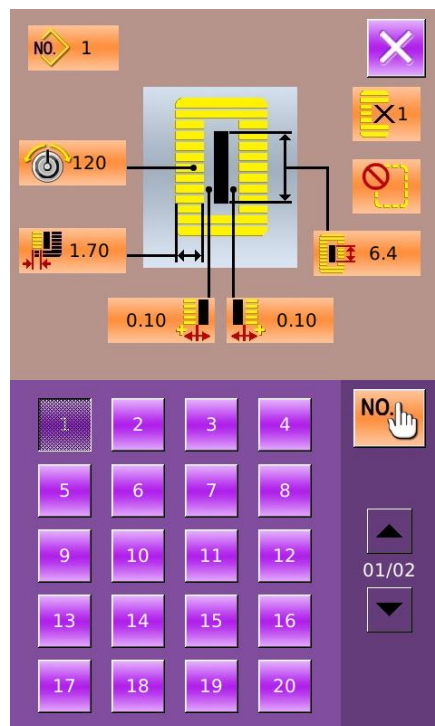

#### ② Input the newly registered pattern number

In the interface, the upper area displays the shape and relevant sewing data of the copied pattern. The user can select the unregistered pattern number via the numeral keys. The registered pattern number can't be registered again.



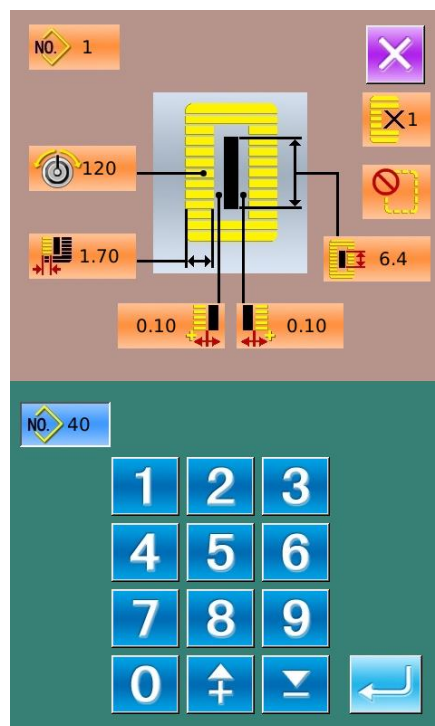

A、Press  to finish the operation of copying the pattern. And return to the pattern copy interface



B、Press  to quit the number input interface directly.



### 4. 4 Pattern Naming

Press  to enter the interface for naming pattern (as shown in the right figure), 12 figures can be inputted at the most.

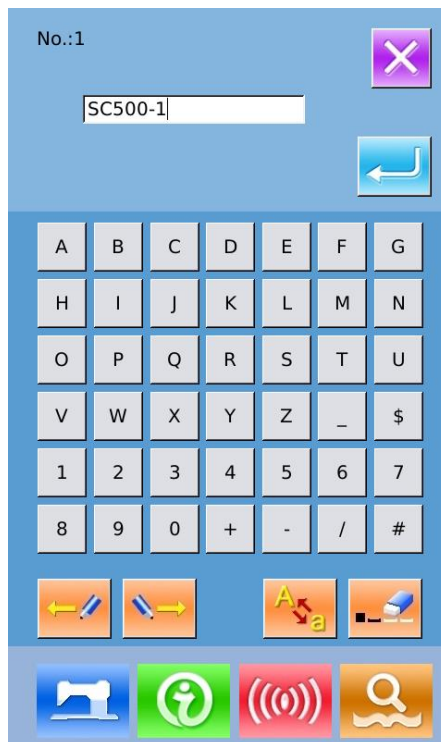

-  : Icon Right-moving
-  : Icon Left-moving
-  : Caps Locks
-  : Eraser

- A、 Select the figure wanted, press  to end the operation of naming the pattern.
- B、 The position of figure can be determined by moving the icon, the Eraser is used to delete the figure
- C、 Press  to quit directly.



### 4. 5 Threading

Press  to enter the interface of threading; at this moment, the presser foot is lowering. Pressing the Presser Foot Up will lift the presser and have the screen to return to the main interface.

-  : Presser Down
-  : Presser Up

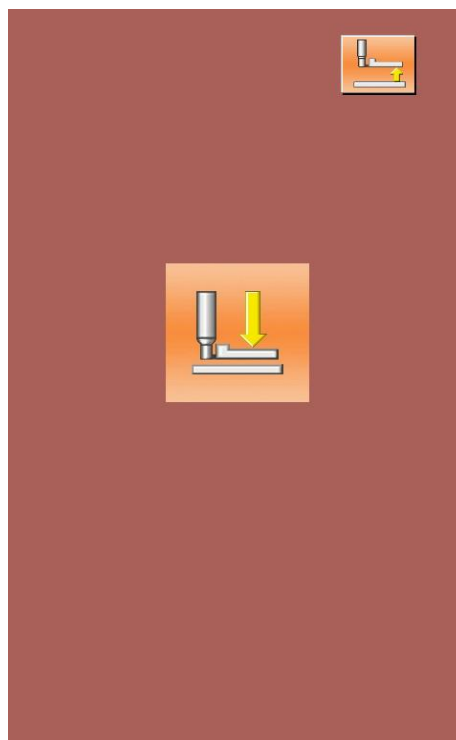

## 4.6 Winding

### ① Install the shuttle core

Fit the shuttle core fully onto the winder shaft. Then push the thread guide in the direction of the arrow (as shown in the figure in right)

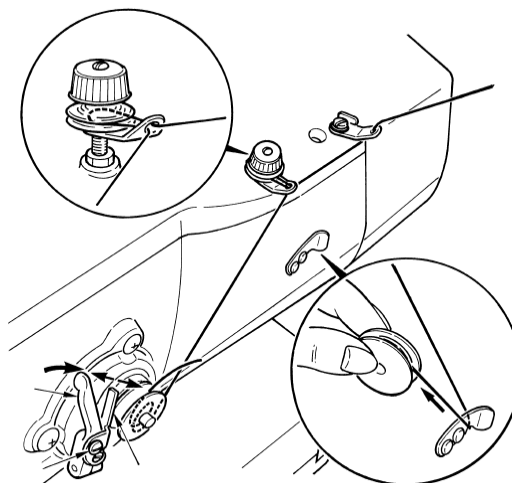

### ② Display the bobbin thread winding screen

Press  in the data input interface (orange) or the sewing interface (blue), and then the winding interface will be displayed (as shown in the right figure)

### ③ Start Winding

Step the start pedal, and then the sewing machine runs and starts winding bobbin thread.

### ④ Stop the sewing machine

Press STOP button  to stop the sewing machine. The system will return to the normal mode. By the way, in the bottom-thread winding mode, stepping the start pedal will stop the machine at this mode. Step the pedal again to resume winding. This function can be used at winding several shuttle cores.

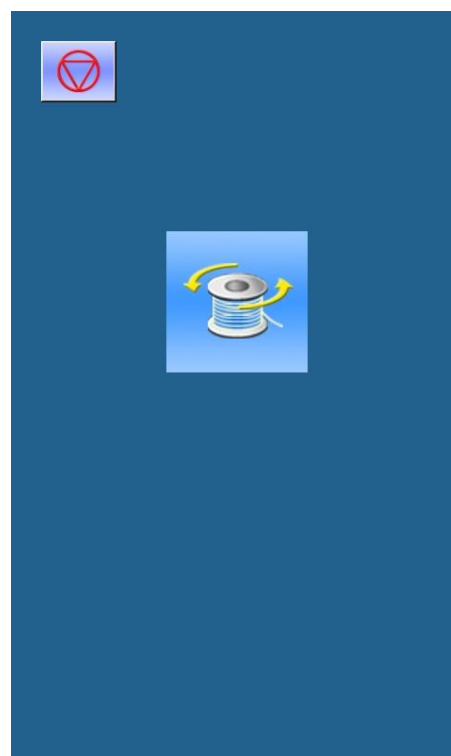

### 4. 7 Select the Type of Presser

① Display the data input Interface

Only at the data input interface (orange), can user change the contents of setting. In the sewing interface (blue), press READY key to display the data input interface.

② Call the interface for selecting presser type

Press Presser Type Selection (A) to display the interface for selecting the presser type (as shown at right).

③ Select the type of presser

Press button of presser type according to the presser mounted on the sewing machine. The button pressed is displayed in shadow. For selecting the presser type, please refer to the table below

	Type	Presser Type
	Type 1	
	Type 2	
	Type 3	
	Type 5	—

※ Set type 5 when using the presser foot other than type 1 to 3. Change memory switch (level 1) according to U15 Presser size width and U16 Presser size length. When using type 5 with stitch width at 6 mm or more and length at 41 mm or more, it is necessary to replace components such as presser arm, feed plate, etc

④ Determine the presser type

Press to close the interface and finish the

change. Pressing is to quit directly

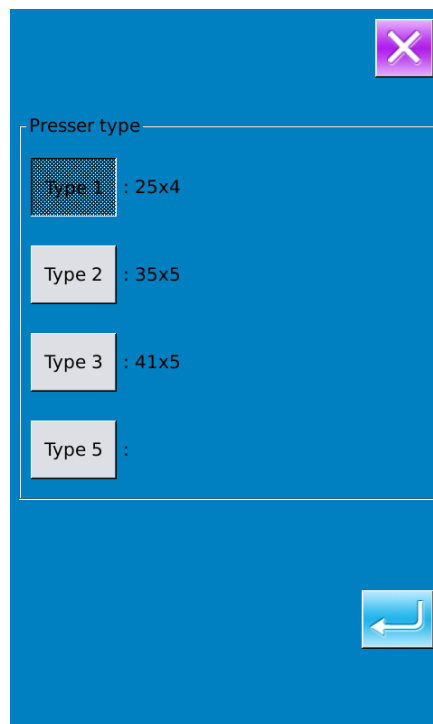
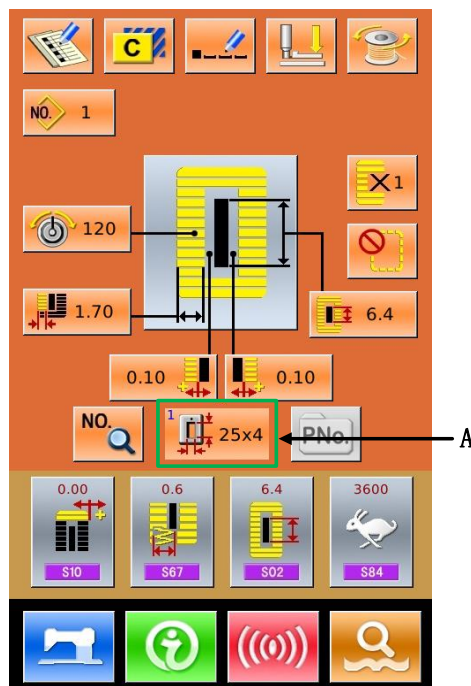

## 4.8 Pattern Selection

Press  to enter the interface for selecting pattern (as shown in the right figure), the upper area shows the shape and relevant data of the selected pattern while the lower area shows the registered number of the pattern.

: Input the number to inquire pattern

: Delete the pattern

### ① Pattern Selection

Every 20 numbers will be showed in one page, if exceeding, the page-turning key will be displayed and available in the interface. When the number of the registered pattern is selected, the upper area of the interface will show the details of the pattern.

Press  to finish the operation of pattern selection.

Press  to quit the Pattern Selection.

### ② Pattern Inquiry

Press  to activate the interface of Pattern Inquiry, input the number of pattern via the number keys, as shown in Figure 2

### ③ Pattern Deletion

Select the registered pattern and then press , the pattern will be deleted. However, the patterns in following three kinds can't be deleted

- A: Patterns included in continuous sewing
- B: Patterns included in cyclic sewing
- C: Patterns registered to P pattern

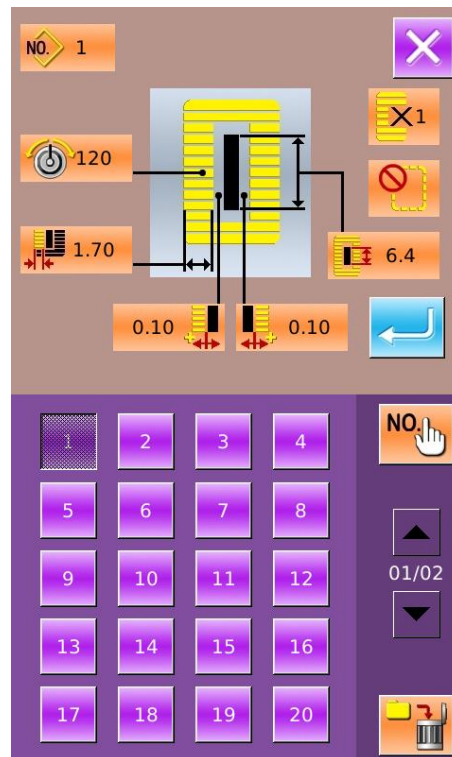

Figure 1

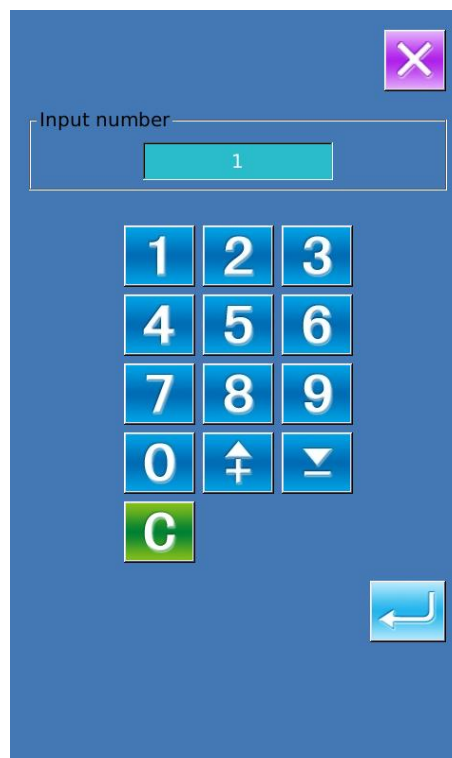



Figure 2

## 4.9 Sewing Shape Selection



Press  to enter the interface for selecting the sewing shape

### ① Select the 1<sup>st</sup> bar-tacking

There are five common 1<sup>st</sup> bar-tacking shapes, which are Square Type, Radial Type, Eyelet Type, Semi-lunar Type and the Round Type. When the parameter K04 is set to 30, another 4 types of bar-tacking section can be used, which are bar-tacking section sewing, bar-tacking with left cut, bar-tacking with right cut and bar-tacking with center cut. Select the 1st bar-tacking section to enter the interface for selecting the shape. For the pattern from No.27 ~No.30, the user can press



to end the selection



Press to quit directly.

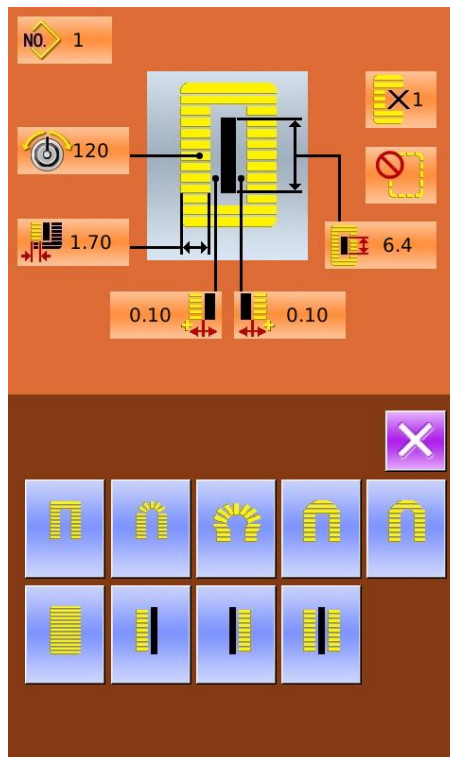

- Note:**
1. The display of 1<sup>st</sup> bar-tacking section is affected by parameter K04;
  2. When changing the 1<sup>st</sup> bar-tacking section, user has to change the sewing parameters of the relating shape. Otherwise, it may affect the data at pattern-designing or the sewing effect;
  3. For the default parameter value of the shape, please refer to 10.4 “Sewing Default Value List” in Appendix 1

② Finish the sewing shape selection

Select the end shape; press  to return to the main interface.

Press  to quit directly. The shape number will not be changed either

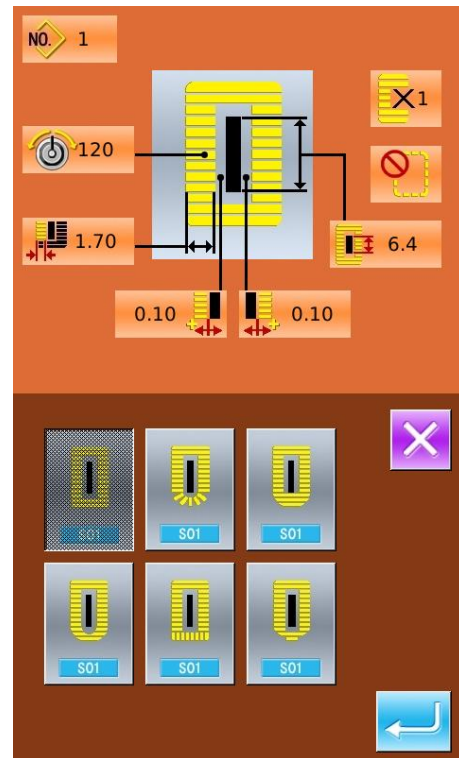











③ Parameter K04

	K04 = 12	K04 = 20	K04 = 30
<b>Square</b>	1	1, 18, 19, 20	1, 18, 19, 20, 21, 22
<b>Radial</b>	3, 4, 5, 6	3, 4, 5, 6	3, 4, 23, 24, 5, 6
<b>Eyelet</b>	7, 8, 9, 10	7, 8, 16, 17, 9, 10	7, 8, 16, 17, 9, 10
<b>Semi-lunar</b>	11	13, 11, 14, 15	13, 25, 11, 26, 14, 15
<b>Round</b>	12, 2	12, 2	12, 2
<b>Bar-tacking</b>			27, 28, 29, 30





















Note 1: The numbers in form are the number of shape.

Note 2: The sewing shapes of No.27, 28, 29 and 30 can only be available when parameter K04 is set at 30.

④ Sewing Shape List

01 Square 	02 Round 	03 Radial Square 	04 Radial 	05 Radial Straight Bar-tacking 
06 Radial Taper Bar-tacking 	07 Eyelet Square 	08 Eyelet Radial 	09 Eyelet Straight Bar-tacking 	10 Eyelet Taper Bar-tacking 

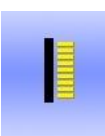

11 Semi-lunar 	12 Round Square 	13 Semi-lunar Square 	14 Semi-lunar Straight Bar-tacking 	15 Semi-lunar Taper Bar-tacking 
16 Eyelet Semi-lunar 	17 Eyelet Round 	18 Square Radial 	19 Square Semi-lunar 	20 Square Round 
21 Square Straight Bar-tacking 	22 Square Taper Bar-tacking 	23 Radial Semi-lunar 	24 Radial Round 	25 Semi-lunar Radial 
26 Semi-lunar Round 	27 Bar-tacking 	28 Bar-tacking Right Cut 	29 Bar-tacking Left Cut 	30 Bar-tacking Center Cut 

### 4. 10 Sewing Data Setting

#### ① Change Sewing Data

Press  to enter the interface for setting sewing (as shown in right figure).  
 Select the sewing data for changing; Then the system will enter the setting status. The parameters with **purple** background are the input type, while the parameters with **blue** background are the selection type

Press  to quit the Sewing Data Setting.

Example at below:

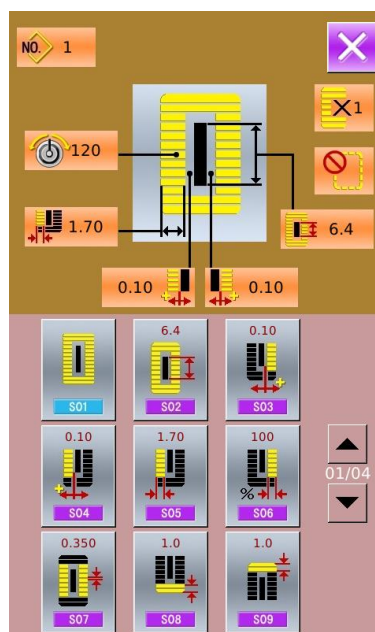

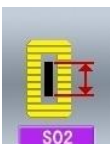
Select  to enter the interface (as shown in right).

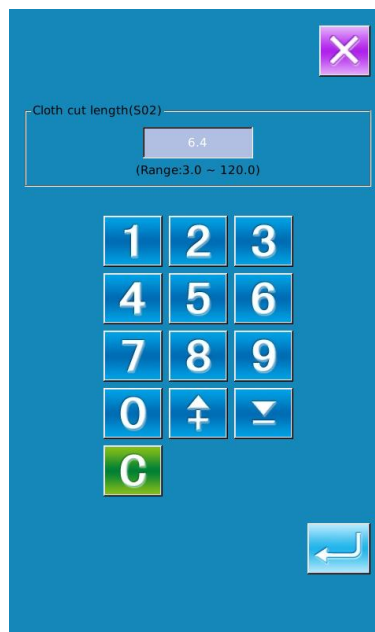

Select  to enter the interface(as shown in right).

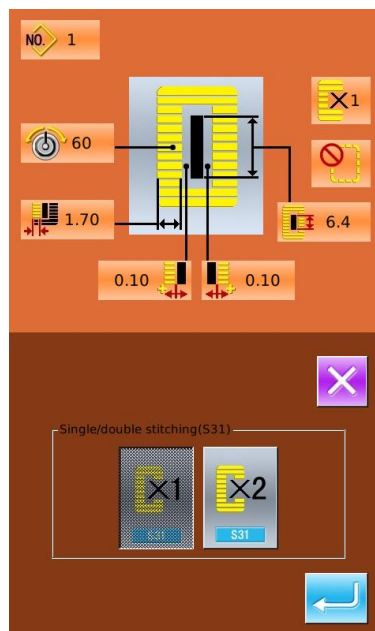

② Sewing Data List















The sewing data is related to the sewing shape selected. The different shape has the different sewing data with different default values

In mode status, user can set whether to open some sewing data. By the way, there are also some sewing data that are affected by others.

No.	Item	Range	Unit	Remarks
 S01	Sewing shape Refer to 4.9 Selection of Sewing Shape	1~30	1	Remarks 5



No.	Item	Range	Unit	Remarks
S02 	Length of cloth cutting This item sets the length of cloth that is cut by knife. However, in case of the shapes of No. 27, 28, 29 and 30, sewing length will be set. When activating U19 parameter (knife action number), the machine will cut the fabric according to the value in U18 (knife size).	3.0~120.0	0.1mm	
S03 	Knife groove width, right This item sets the clearance between knife and right parallel section.	-2.00~2.00	0.05mm	
S04 	Knife groove width, left This item sets the clearance between knife and left parallel section.	-2.00~2.00	0.05mm	
S05 	Over-edging width, left This item sets the over-edging width of left parallel section.	0.10~5.00	0.05mm	
S06 	Ratio of right and left shapes This item sets scale ratio of right side shape with the knife position as the center	50~150	1%	
S07 	Pitch at parallel section This item sets sewing pitch between left and right parallel sections.	0.200~2.500	0.025mm	
S08 	2nd bar-tacking length This item sets length of bar-tacking on the front side  Square Down  Bar-tacking Down   Taper Down 	0.2~5.0	0.1mm	
S09 	1st bar-tacking length This item sets length of bar-tacking on the rear side  Square Up 	0.2~5.0	0.1mm	
S10 	Compensation of bar-tacking width, right This item adjusts right over-edging section. of bar-tacking part Both 1st and 2nd bar-tacking can be adjusted  Square Up  Square Down   Bar-tacking Down 	-1.00~1.00	0.05mm	

No.	Item	Range	Unit	Remarks
S11 	Compensation of bar-tacking width, left This item adjusts left over-edging section of bar-tacking part	-1.00~1.00	0.05mm	
S12 	Left Taper Bar-tacking This item sets length of bar-tacking section in taper bar-tacking shape	0.00~3.00	0.05mm	Remarks 1
S13 	Right Taper Bar-tacking This item sets length of bar-tacking section in taper bar-tacking shape	0.00~3.00	0.05mm	Remarks 1
S14 	Eyelet shape length This item sets upper side length from center of eyelet in the eyelet shape	1.0~10.0	0.1mm	Remarks 1
S15 	Number of stitches of eyelet shape This item sets number of stitches in the upper 90 ° of eyelet shape	1~8	1	Remarks 1
S16 	Eyelet width This item sets the inside crosswise size of the eyelet shape. Actual needle entry point is the dimension to which S04 Knife groove width, left is added.	1.0~10.0	0.1mm	Remarks 1
S17 	Eyelet length This item sets lengthwise size of the inside of eyelet shape.	1.0~10.0	0.1mm	Remarks 1
S18 	Round type shape length This item sets upper side length from the center of round shape Round Up  Radial Up  Semi-lunar Up  Round Down  Radial Down  Semi-lunar Down 	1.0~5.0	0.1mm	Remarks 1
S19 	Number of radial shape stitches This item sets number of stitches in the upper 90 ° of radial shape	1~8	1	Remarks 1
S20	Radial bar-tacking: This item sets with / without bar-tacking stitches of radial shape  : No  : Yes			Remarks 1 Remarks 2
S21 	Pitch at bar-tacking section This item sets the pitch of bar-tacking section. Square Up  Round Up  Semi-lunar Up  Square Down  Round Down  Semi-lunar Down 	0.200~2.500	0.025	

No.	Item	Range	Unit	Remarks
	Straight Bar-tacking Down  Taper Down 			
S22 	1 <sup>st</sup> Clearance This item sets the clearance between 1st bar-tacking and knife groove. This item is applied to all shapes	0.0~4.0	0.1mm	
S23 	2 <sup>nd</sup> Clearance This item sets the clearance between 2nd bar-tacking and knife groove. This item is applied to all shapes	0.0~4.0	0.1mm	
S31	Single/ Double Sewing   : Single Sewing : Double Sewing			
S32	Select Cross at Double Sewing At setting the double sewing, user can select parallel sewing and crossing sewing  : Parallel Sewing  : Cross Sewing			Remark 3
S33 	Compensation of Double Sewing Width This item sets amount to narrow over-edging width of 1st cycle at double stitching.	0.0~2.0	0.1mm	Remark 3
S34	Number of Basting Times This item sets number of basting times.  : Without basting  : 1~9	0~9	1 Time	
S35 	Basting Pitch This item sets pitch at performing the basting.	1.0~5.0	0.1mm	Remark 3
S36 	Rolling Length of Basting This item sets rolling length of needle thread at performing basting.	2.0~20.0	0.1mm	Remark 3
S37 	Rolling Pitch of Basting This item sets rolling pitch of needle thread at performing basting.	0.2~5.0	0.1mm	Remark 3
S38 	Rolling Width of Basting This item sets rolling width of needle thread at performing basting.	0.0~4.0	0.1mm	Remark 3
S39 	Lengthwise Compensation of Needle Entry at Basting This item sets the amount to move needle entry position back and forth at performing basting more than two cycles	0.0~2.5	0.1mm	Remark 2 Remark 3

No.	Item	Range	Unit	Remarks
S40	 <p>Horizontal Compensation of Needle Entry at Basting This item sets the amount to move needle entry position left and right at performing basting more than two cycles.</p>	0.0~1.0	0.1mm	Remark 3
S41	 <p>Compensation of Left Side Position at Basting This item sets the adjustment amount of the standard sewing position at basting from the center of left over-edging.</p>	-2.0~2.0	0.1mm	Remarks 2 Remarks 3
S42	 <p>Compensation of Right Side Position at Basting This item sets the adjustment amount of the standard sewing position at basting from the center of right over-edging.</p>	-2.0~2.0	0.1mm	Remarks 2 Remarks 3
S44	 <p>Basting Speed Set Speed of Basing</p>	400~4200	100rpm	Remarks 3 Remarks 4
S45	<p>Pair-sewing: Select the Start of Sewing。</p>  : Activate  : Deactivate <p>After selecting “Activate”, user can perform the sewing in the order of “Pair Sewing -&gt;Basting-&gt; Normal Sewing”.</p>			
S46	 <p>Pair-sewing Width Set the width at pair-sewing.</p>	1.0~10.0	0.1mm	Remarks 2 Remarks 3
S47	 <p>Pair-sewing Pitch Set the pitch at pair-sewing.</p>	0.2~5.0	0.1mm	Remarks 2 Remarks 3
S51	 <p>Left Parallel Tension Set the needle thread tension at left parallel part.</p>	0~200	1	
S52	 <p>Right Parallel Tension Set the needle thread tension at right parallel part.</p>	0~200	1	Remark 2
S53	 <p>Left Parallel Tension (1<sup>st</sup> lap at double sewing) At double sewing, set the needle thread tension at the 1<sup>st</sup> lap in the left parallel part</p>	0~200	1	Remarks 2 Remarks 3
S54	 <p>Right Parallel Tension (1<sup>st</sup> lap at double sewing) At doubling sewing, set the needle thread tension at the 1<sup>st</sup> lap in the right parallel part</p>	0~200	1	Remarks 2 Remarks 3
S55	 <p>1<sup>st</sup> Bar-tacking Tension Set the upper the read tension at the 1<sup>st</sup> bar-tacking part</p>	0~200	1	

No.	Item	Range	Unit	Remarks
S56 	2 <sup>nd</sup> Bar-tacking Tension Set the upper the read tension at the 2 <sup>nd</sup> bar-tacking part	0~200	1	Remark 2
S57 	Set Needle Thread Tension at Sewing Start Set the needle thread tension of bar-tacking at sewing start	0~200	1	
S58 	Set the Needle Thread Tension at Basting Set the needle thread at basting	0~200	1	Remark 3
S59 	ACT Timing Adjustment at 1st Bar-tacking Start This item adjusts the start timing of needle thread tension output at 1st bar-tacking section.	-5~5	1 Stitch	Remark 2
S60 	ACT Timing Adjustment at Right Over-edging Start This item adjusts the start timing of needle thread tension output at right over-edging.	-5~5	1 Stitch	Remark 2
S61 	ACT Timing Adjustment at 2nd Bar-tacking Start This item adjusts the start timing of needle thread tension output at 2nd bar-tacking section.	-5~5	1 Stitch	Remark 2
S62 	Bar-tacking Stitch Number at Sewing Start Set the stitch number of bar-tacking sewing at sewing start	0~8	1 Stitch	
S63 	Bar-tacking Pitch at Sewing Start Set the stitch pitch of bar-tacking sewing at sewing start	0.00~0.70	0.05mm	Remark 2
S64 	Bar-tacking Width at Sewing Start Set the width of bar-tacking sewing at sewing start	0.0~3.0	0.1mm	
S65 	Vertical Adjustment of Bar-Tacking Sewing at Sewing Start Set the vertical start position of bar-tacking sewing at sewing start	0.0~5.0	0.1mm	Remark 2
S66 	Horizontal Adjustment of Bar-Tacking Sewing at Sewing Start Set the horizontal start position of bar-tacking sewing at sewing start	0.0~2.0	0.1mm	Remark 2
S67 	Bar-tacking Width at Sewing End Set the width of bar-tacking sewing at sewing end	0.1~1.5	0.1mm	
S68 	Bar-tacking Stitch Number at Sewing End Set the stitch number of bar-tacking sewing at sewing end	0~8	1 Stitch	
S69 	Vertical Adjustment of Bar-Tacking Sewing at Sewing End Set the vertical start position of bar-tacking sewing at sewing start	0.0~5.0	0.1mm	Remark 2

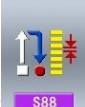
No.	Item	Range	Unit	Remarks
 S70	Horizontal Adjustment of Bar-Tacking Sewing at Sewing End Set the horizontal start position of bar-tacking sewing at sewing start	0.0~2.0	0.1mm	Remark 2
S81	Knife motion This item sets "With/without motion" of knife.  : Knife Off  : Knife On			
S83	Knife motion at 1st lap of double stitching This item sets "With/without motion" of cloth cutting knife at 1st lap at double stitching  : Knife Off  : Knife On			Remarks 2 Remarks 3
 S84	Max Speed Limitation This item sets max speed of the sewing machine. The value is limited by the K07(Set maximum speed limitation)	400~4200	100rpm	Remarks 4
 S86	Pitch of Forward This item sets sewing pitch at forward side of bar-tacking shape (Shape No. 27, 28, 29 and 30 of S01)	0.200~2.500	0.025	Remarks 1
 S87	Width of Forward This item sets sewing width at forward side of bar-tacking shape (Shape No. 27, 28, 29 and 30 of S01)	0.10~3.00	0.05mm	Remarks 1
 S88	Pitch of Return This item sets sewing pitch at return side of bar-tacking shape (Shape No. 27, 28, 29 and 30 of S01)	0.200~2.500	0.025mm	Remarks 1
 S89	Width of Return This item sets sewing width at return side of bar-tacking shape (Shape No. 27, 28, 29 and 30 of S01)	0.10~3.00	0.05mm	Remarks 1

**Remarks 1: Displayed according to the shape**

**Remarks 2: Displayed when it is set as activation**

**Remarks 3: Displayed when the function is selected**

**Remarks 4: It is limited by parameter K07**

**Remarks 5: When change the shape of 1<sup>st</sup> bar-tacking sewing, user needs to change the sewing parameters**



of the relating shape. Otherwise it will affect the generation of the pattern-designing data or the sewing effect

### 4.11 Direct Selection of Pattern

The user can register the 10 frequently used patterns to



the direct keys for selecting directly, press to enter the interface of selection as shown below.

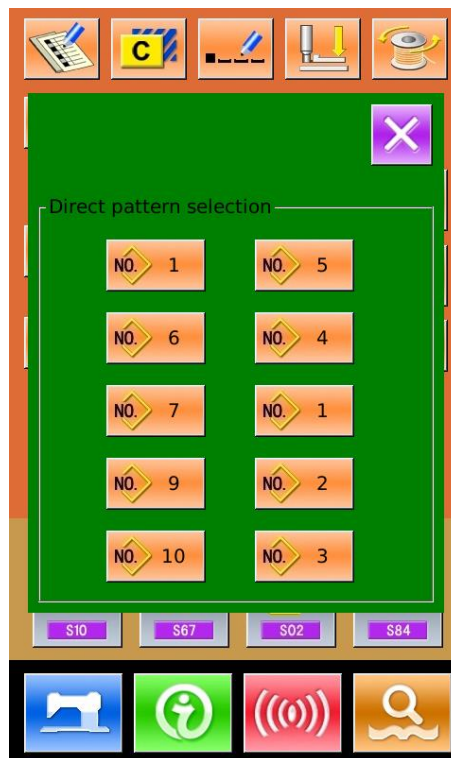

## 4.12 Trial Sewing





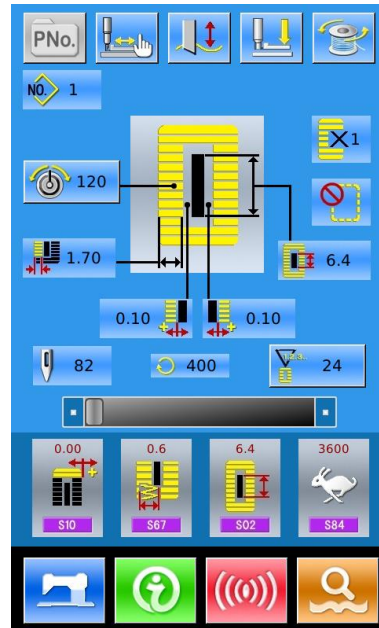





### (1) Display the interface of sewing

At data input interface, press , the background of screen will change to blue, and the system enters the interface for sewing.





### (2) Display of Trial Sewing

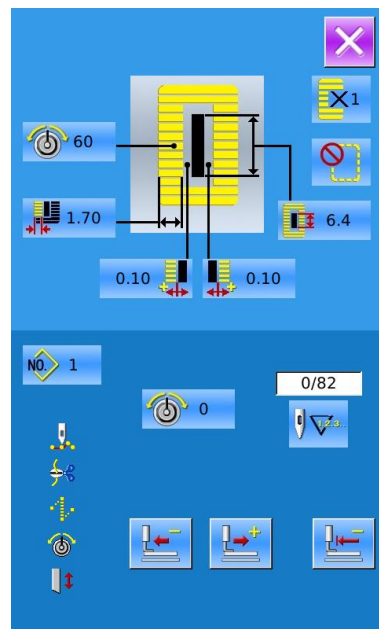

In the sewing interface. Press  to enter the trial sewing interface (As Shown at Right):

-  : Return to Origin
-  : Return
-  : Forward
-  : Tension at Stitch Point
-  : Current/ Total Stitch Number
-  : Sewing Order
-  : Thread Trimming Order
-  : Jump Feed Order
-  : Thread Tension Order
-  : Knife Driving Order



### (3) Begin Trial Sewing

A、By using 、 and  to start trial sewing (Single Step). Under this mode, step on the pedal switch to start the machine for sewing the leftover stitches.

B、Holding  or  will have system to sew the entire pattern as trial.长

C、During the trial sewing. The relating order marks at left side will be displayed in dark according to the sewing data

Exp: When the sewing data is the thread-trimming, the

figure will turn to .

**(4) End Trial Sewing**

Press  to quit the interface of trial sewing and return to the sewing interface.

### 4.13 Set Needle Thread Tension

**At Changing the Thread Tension**

**⑤ Display the Data Input Interface**

Only on the data input screen (orange) or sewing screen (blue), needle thread tension can be changed. At the sewing screen (blue), press READY switch and display the data input screen (orange).

**⑥ Call the interface for changing the needle thread tension**

Press  to display the interface for changing the needle thread tension (as shown in right figure).

**⑦ Change the Needle Thread Tension**

At the interface for changing the needle thread tension, user can change the needle thread tension at parallel part and bar-tacking part. By selecting





user can set S51, S52, S55 or S56 respectively, among which the S52 and S56 can be deactivated at Edition of Sewing Data in Mode Status.

Press **【Tension 1】****【Tension 2】** to shift between two tension groups

⑧ **Finish the Change of Needle Thread Tension**

Press  to close the interface for changing

Needle thread tension. And end the change.

※ **Change the tension other than that at parallel section and bar-tacking section**

**Set value of tension at: 1.Parallel section; 2.Bar-tacking section**

	Set value on panel			
		⊕	Initial value	⊖
<b>Zigzag Buttonhole</b>	①Parallel section tension	Crest is lowered	1 2 0	Crest is raised
	②Bar-tacking tension	Down Tension	3 5	Needle Thread Tension
<b>Straight Buttonhole</b>	①Parallel section tension	Down Tension	6 0	Needle Thread Tension
	②Bar-tacking tension	Down Tension	6 0	Needle Thread Tension

In case of the radial eyelet shape, set the bar-tacking tension to approximately 120 and make the balance of stitches

**About Zigzag Buttonhole and Straight Buttonhole**

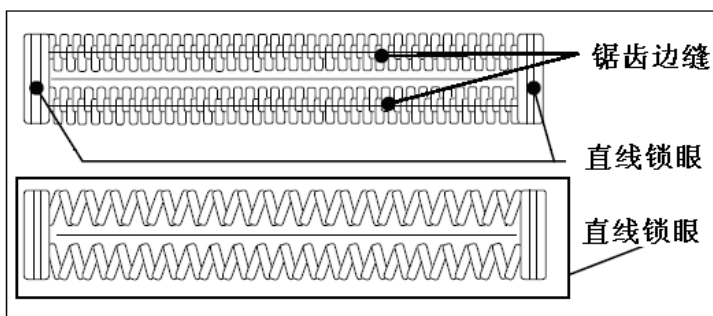

**Zigzag Buttonhole**

It enhances the needle thread tension. It is the zigzag stitch form that pass the center of the stitch form of needle thread at both sides



**Straight Buttonhole**

It is the retrieval stitch form, which only has needle thread on front surface of fabric, while bobbin thread at backside.

**4. 14 Operation of Counter**

(1) **Set Counter**

③ Display the counter interface

In the sewing interface, press  () , the interface of counter setting comes out.



: Sewing Counter



: No. of Pieces Counter

The user can set the type of counter by choosing



and



, and set the value of counter

A、 Press  to activate the setting at return

B、 Press  to cancel the operation and return

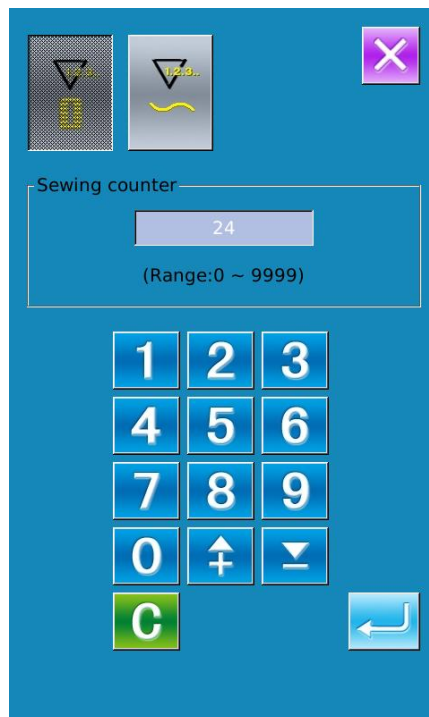

### 4. 15 Emergency Stop

When STOP switch is pressed during sewing, the sewing machine interrupts sewing and stops. The interface, as the figure at right, is displayed

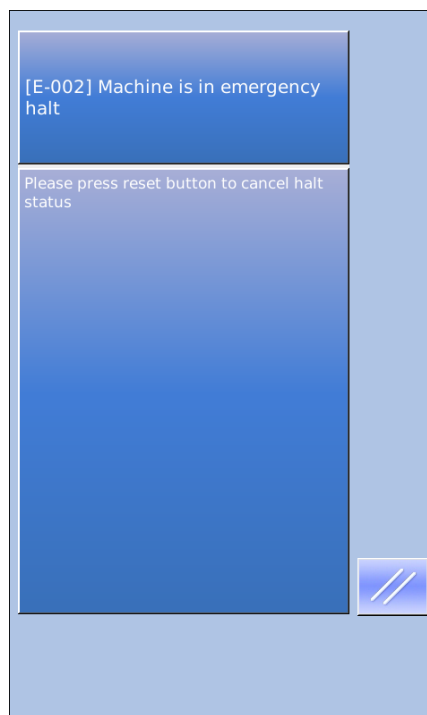

Press  to release the error. And the interface of single-step motion comes out (shown as the figure at right)

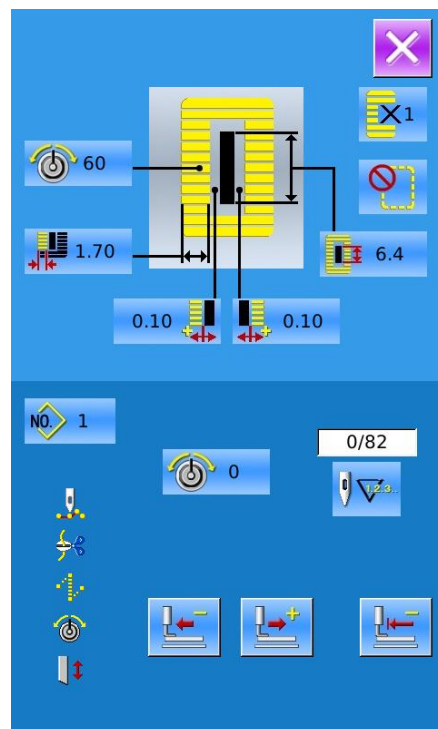



The operation is same as the operations in trial sewing. Step the pedal and continue the sewing.

## 4. 12 VDT Pattern Operation

### 4. 12. 1 Display and Operation of VDT Pattern

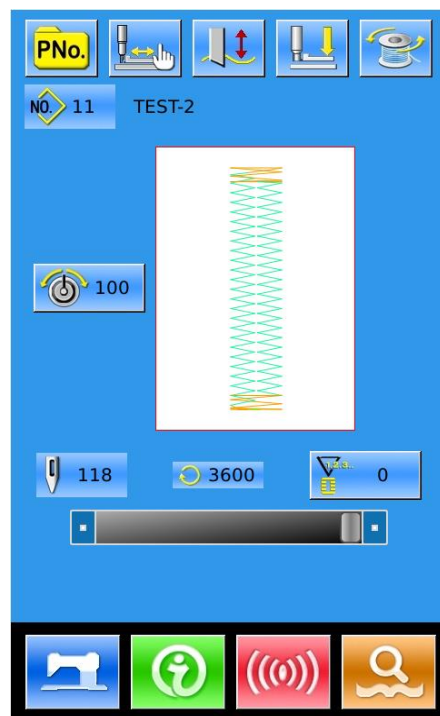
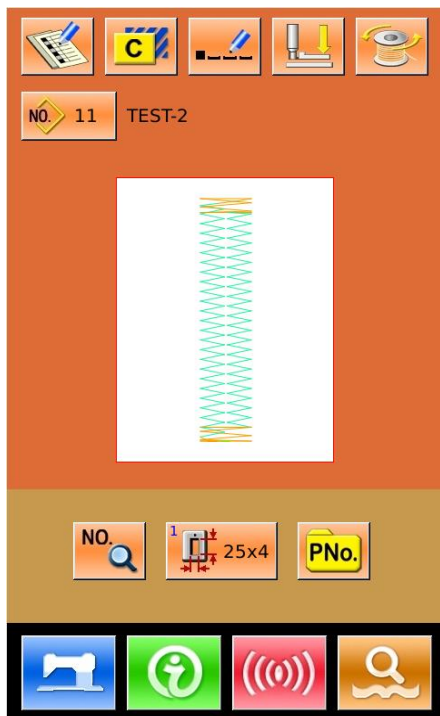
User can use the pattern-making software to create the patterns in VDT format. By inputting it from U disk to memory, the user can activate the data input interface and sewing interface as below:



Press  to enter the sewing data setting interface, as shown at right:



Press  to cancel the operation and return to main interface.



### 4. 12. 2 Sewing Data of VDT Pattern

Sewing Data List of VDT Pattern:

No.	Item	Range	Unit	Initial Value
-----	------	-------	------	---------------

No.	Item	Range	Unit	Initial Value
 S03	Right Width of Knife Groove Set the interval between the knife and right parallel part.	-2.00~2.00	0.05mm	0
 S04	Left Width of Knife Groove Set the interval between the knife and left parallel part	-2.00~2.00	0.05mm	0
S81	Knife motion This item sets "With/without motion" of knife.  : Knife Off  : Knife On			Knife On
 S84	Max Speed Limitation This item sets max speed of the sewing machine. The value is limited by the K07(Set maximum speed limitation)	400~4200	100rpm	Parameter K07
 S91	1 <sup>st</sup> Pitch Adjustment	-9~9	1 针	0
 S92	2 <sup>nd</sup> Pitch Adjustment	-9~9	1 针	0
 S93	Scale Ratio (X Direction)	20~200	1%	100
 S94	Scale Ratio (Y Direction)	20~200	1%	100
 S95	Standard Tension	0~200	1	100



# 5 Continuous Sewing

This kind of sewing can sew 6 shapes at most without lifting presser. At most, 50 continuous sewing patterns can be registered.

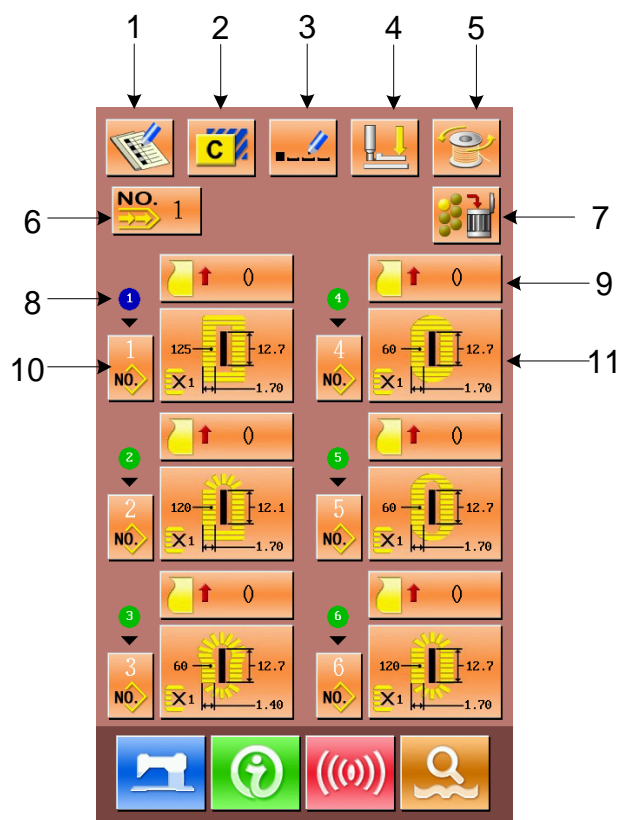

## 5. 1 Function List

No	Figure	Function	Remarks
1		New Pattern Registration	
2		Pattern Copy	
3		Pattern Naming	
4		Threading	
5		Winding	
6		Select Pattern for Continuous Sewing	
7		Delete All	Delete the entire sub-pattern in the existing continuous pattern
8		Sewing Order	

No	Figure	Function	Remarks
9		Feeding Amount Input	
10		Sub-pattern Selection	
11		Sewing Data Edition	



## 5. 2 Edition of Continuous Sewing

### 5. 2. 1 Selection of Continuous Sewing Pattern

Press  to enter the interface for selecting the pattern

(as shown in right figure).

Please operate in the following way:

A、 Press  &  to look up the information of the registered patterns in continuous stitching.

B. Press  to select pattern via number

C、 Press  to delete the selected pattern

D、 Select the proper pattern, press  to end the selection and to return the main interface.

E、 Press  to cancel the operation and return to main interface

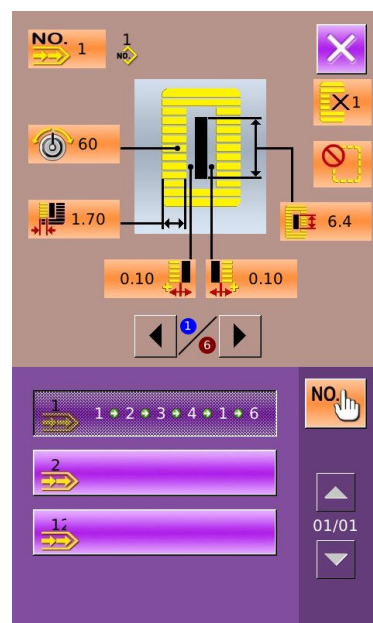

### 5. 2. 2 Edition of Continuous Sewing Pattern

#### ① Set Cloth-feeding Amount

Press  (In figure 1) to enter the interface for setting the feeding amount (figure 2).

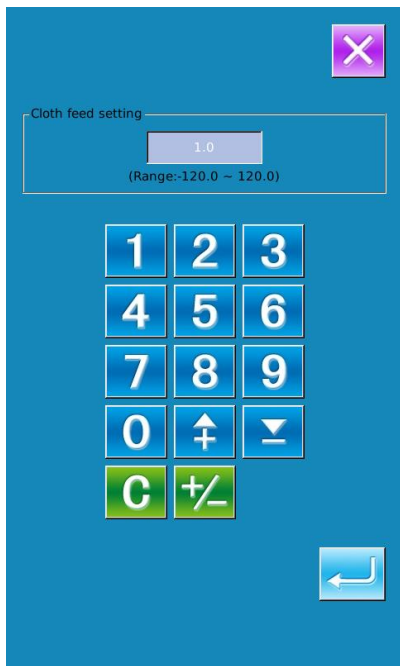

Figure 2

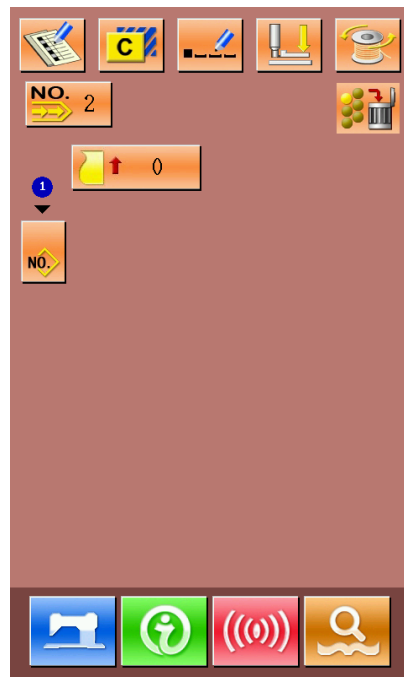





Figure 1

④ Select Pattern

Press  to enter the interface for selecting pattern (as shown in right figure)

A、 In this interface, there are two ways to select pattern:

- Press  to input the pattern number
- Input pattern number directly

B、 Press  to delete the currently selected pattern

C、 Press  to cancel the operation

D、 Select the proper pattern and press  to confirm it.

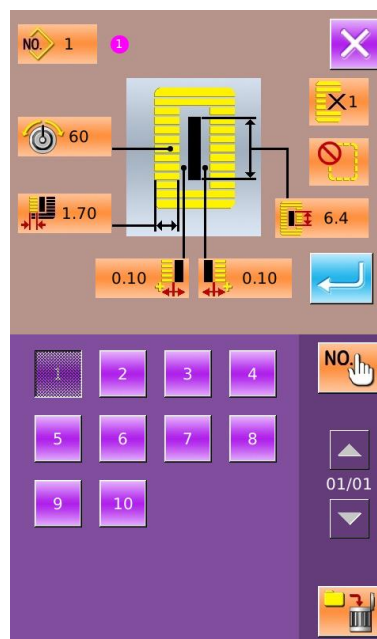

⑤ Change Sewing Data

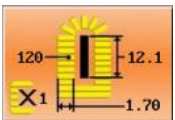
Press  to enter the interface for setting the sewing data (as shown in figure 2 at right).

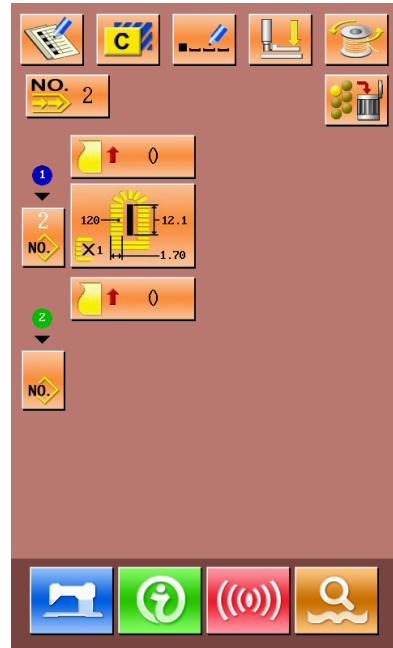

Figure 1

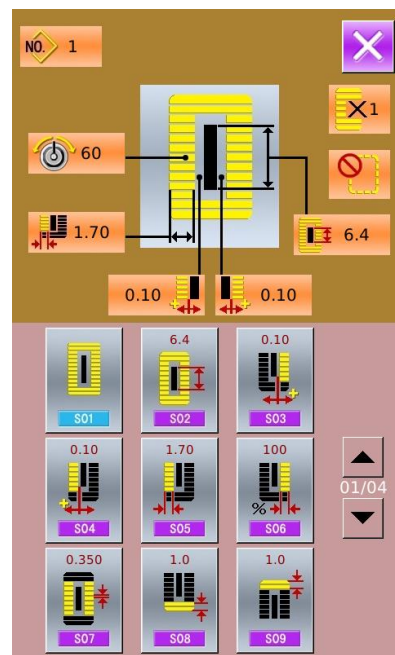





Figure 2

### 5. 2. 3 Continuous Sewing Pattern Registration

50 continuous patterns can be registered for the most. press  to enter the interface of Pattern Registration (shown as the right figure):

#### ③ Input Pattern No.

Input the number of the pattern via key board. The registered number can't be registered again. By pressing  and , user can search the unregistered number.

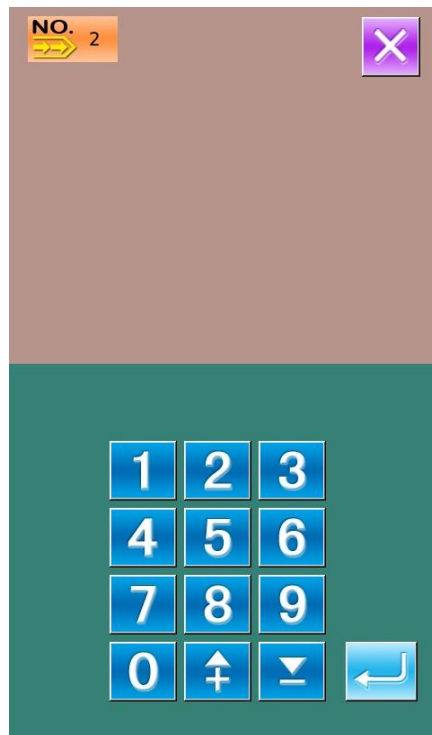

#### ④ Edition of Continuous Sewing

After setting the pattern number, please press



to enter the interface for editing the continuous sewing (as shown in right):

For the following operations, please refer to Section “5.2.2”

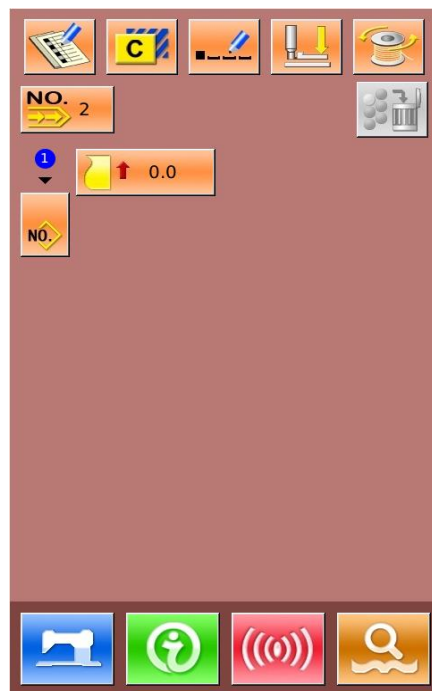



## 5. 2. 4 Continuous Sewing Pattern Copy

### ① Select the target pattern

Press  to enter the interface of pattern copy (as shown at right). Among the registered patterns, select the pattern number of the copied one and

press .

Press  and  to check the pattern shape contained in the continuous sewing

Press  to cancel the copy operation

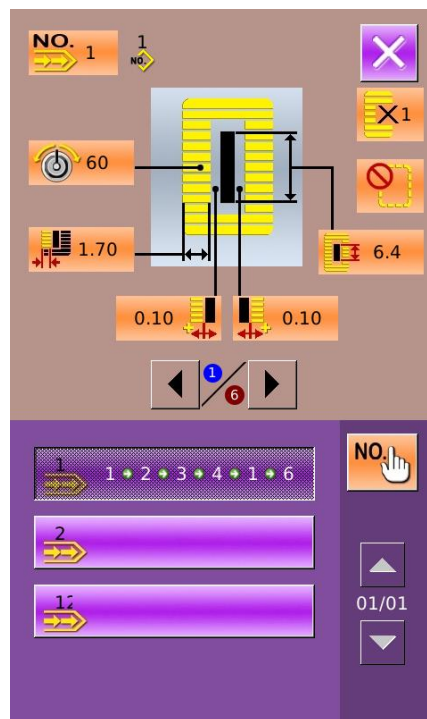

### ② Input the newly registered pattern number

In the interface, the upper area displays the shape and relevant sewing data of the copied pattern. The user can select the unregistered pattern number via the numeral keys.

Press  to finish the pattern copy operation

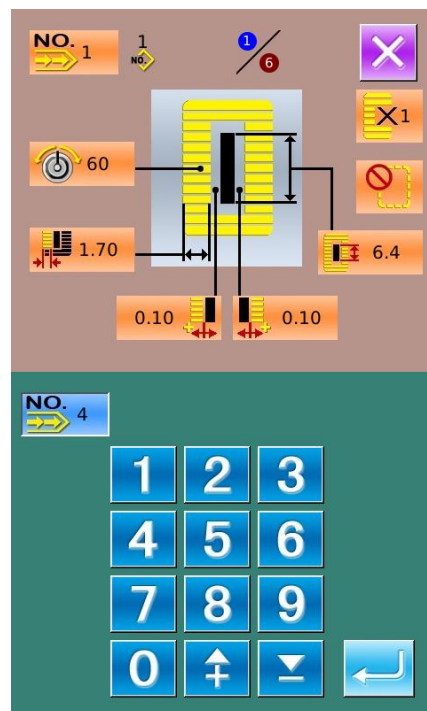

Press  to cancel the operation and return to the upper interface

※ The registered pattern number cannot be registered again.



### 5. 2. 5 Deletion of Continuous Sewing Pattern

④ Select the target pattern

Press  to select pattern. Press  to return to the main interface, as shown at right.

Press  to delete the continuous sewing pattern

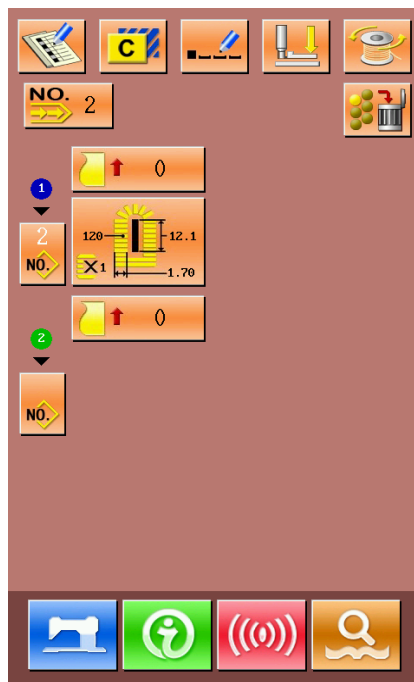

⑤ Confirm the Deletion

Press  to finish the pattern deletion

Press  to cancel the operation

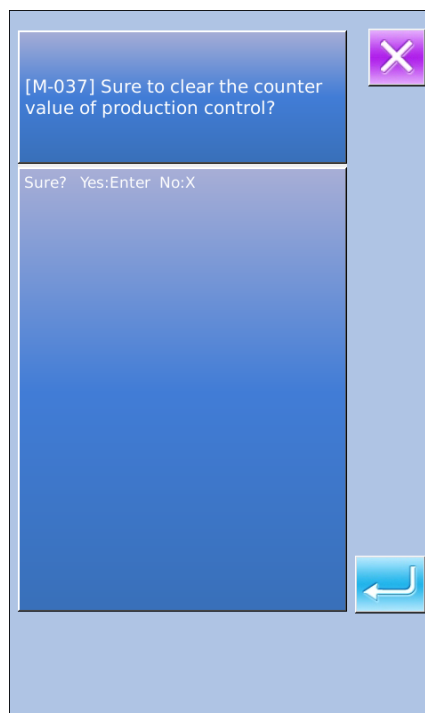

⑥ **Finish the Deletion**

After deleting the continuous sewing pattern, user can have system to return to main interface. Then user can edit the pattern again.

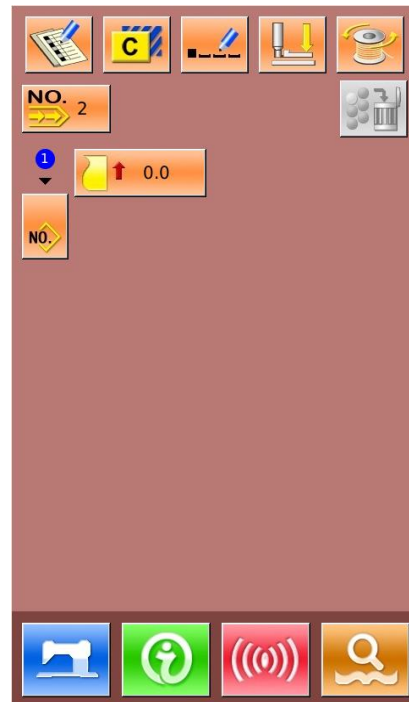

**5. 3 Continuous Sewing Interface**



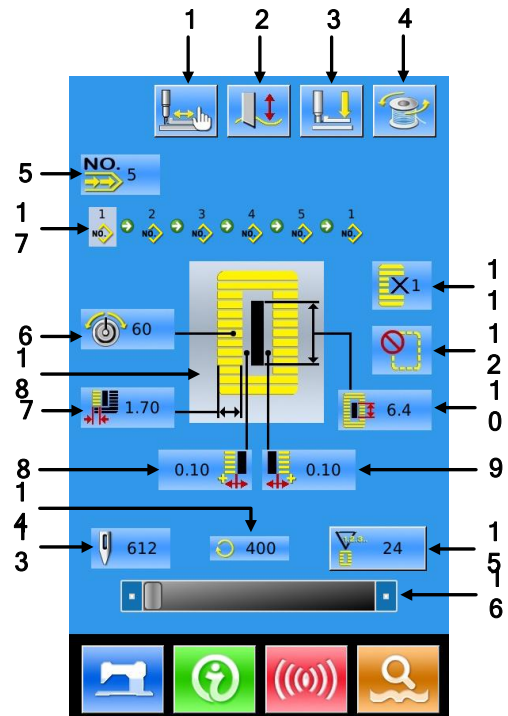















Press  to enter the interface for sewing (as shown in right figure).



**5. 3. 1 Function List**

No.	Figures	Functions	Remarks
-----	---------	-----------	---------



No.	Figures	Functions	Remarks
1		Trial Sewing	
2		Knife Function	Shift knife functions
3		Threading (Presser Down)	
4		Winding	
5		Pattern Number Display	
6		Needle Thread Tension Setting	
7		Left Over-edging Width	
8		Left Width of Knife Groove	
9		Right Width of Knife Groove	
10		Length of Cloth Cutting	
11		Single Sewing/ Double Sewing	
12		Number of Basting	
13		Stitch Number	
14		Current Sewing Speed	
15		Counter Value  : Sewing Counter  : No. of piece counter	
16		Speed Setting	
17		Pattern Number Input at Continuous Sewing Data	
18		Display of Sewing Shape	

### 5.3.2 Trial Sewing for Continuous Sewing





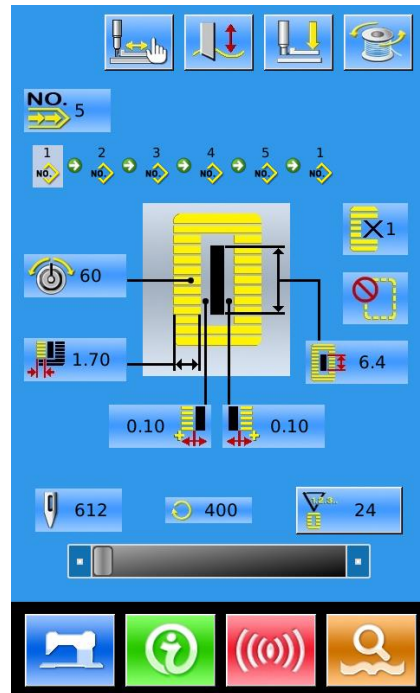





(1) Display the interface of sewing

At data input interface, press , the background of screen will change to blue, and the system enters the interface of sewing.





(2) Display of Trial Sewing

In the sewing interface. Press  to enter the trial sewing interface (As Shown at Right):

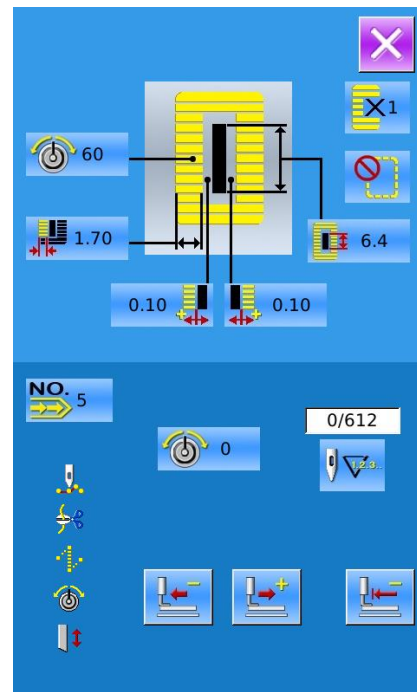
-  : Return to Origin
-  : Return
-  : Forward
-  : Tension at Stitch Point
-  : Current/ Total Stitch Number
-  : Sewing Order
-  : Thread Trimming Order
-  : Jump Feed Order
-  : Thread Tension Order
-  : Knife Driving Order



(3) **Begin trial sewing**

By using ,  and  to start trial sewing. Under this mode, step on the pedal switch to start the machine for sewing the leftover stitches

(4) **End trial sewing**

Press  to quit the interface of trial sewing and return to the sewing interface.

## 6 Cyclic Sewing

This function is used to sew several patterns in a cyclic order. User can input as many as 30 shapes within a cyclic sewing pattern. At most, 50 cyclic sewing patterns can be registered.

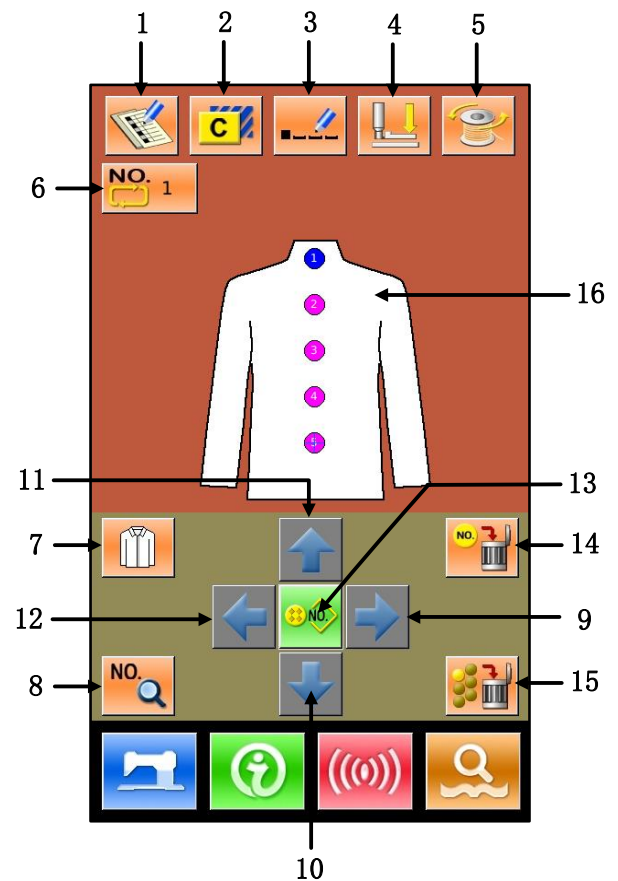



## 6. 1 Function List

No	Figure	Function	Remarks
1		New Pattern Registration	
2		Pattern Copy	
3		Pattern Naming	
4		Threading	
5		Winding	
6		Select Pattern for Cyclic Sewing	
7		Selection of Fabric	
8		Sewing Data Change	
9~12		Direction Key	
13		Pattern Selection	
14		Delete Sub-pattern	Delete the sub-pattern covered by icon
15		Delete All Sub-pattern	Enable to delete the entire sub-pattern within the current cyclic sewing
16		Sewing Order	

## 6. 2 Edition of Cyclic Sewing

### 6. 2. 1 Pattern Registration

Input the pattern number via number keyboard

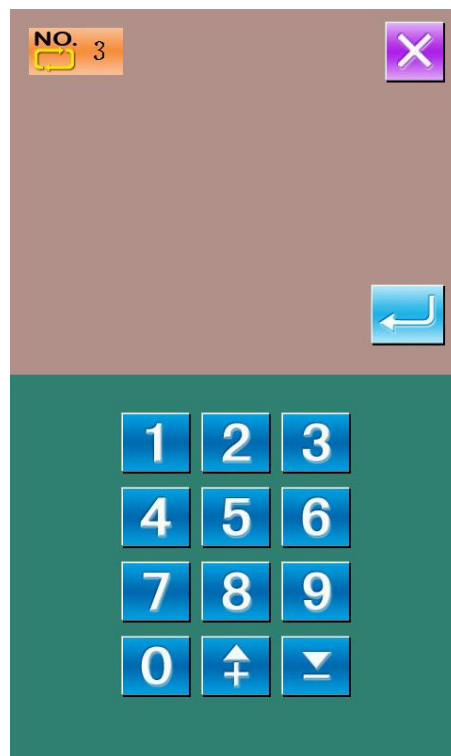

Press  to end selection

Press  to quit selection



## 6. 2. 2 Pattern Copy

### ① Select the target pattern

Press  to enter the interface of pattern copy (as shown at right). Among the registered patterns, select the pattern number of the copied one and press .

Press  to quit the copy operation.

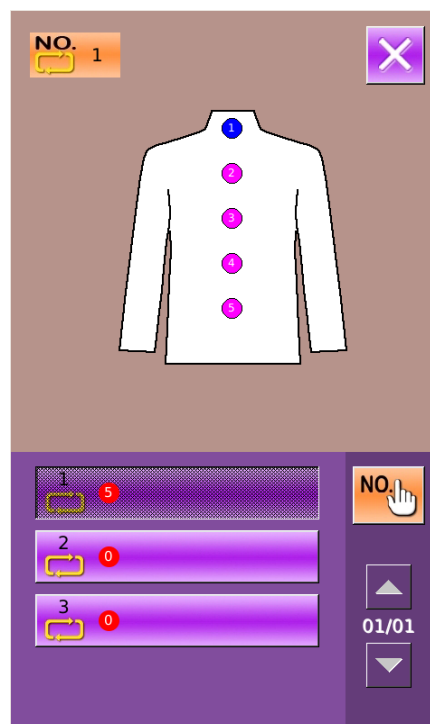

② Input the newly registered pattern number

In the interface, the upper area displays the shape and relevant sewing data of the copied pattern. The user can select the unregistered pattern number via the numeral keys. But the registered pattern number cannot be registered again.

Press  to finish the pattern copy operation

Press  to quit

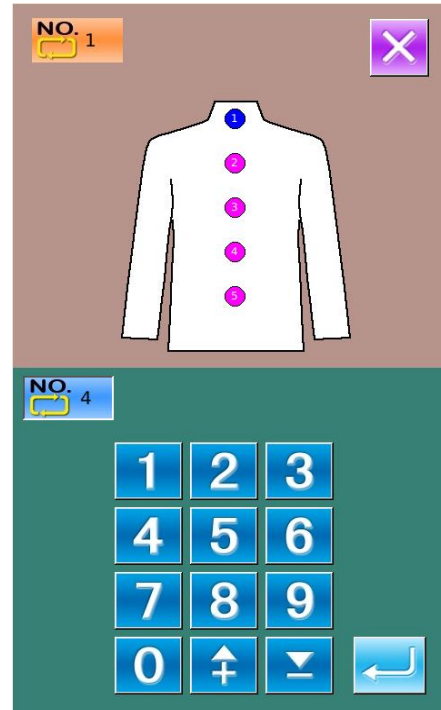

6. 2. 3 Selection of Cyclic Sewing Pattern

Press  to enter the interface for selecting the cyclic sewing pattern (as shown in right).

The operation is same to the operation of normal pattern selection.

Press  to quit the pattern selection

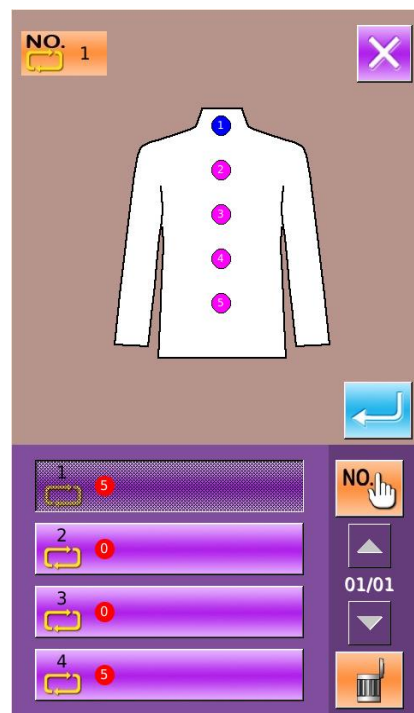

## 6. 2. 4 Edition of Cyclic Sewing Pattern

### ④ Start Edition

Press the direction keys , ,  &  to

select the position wanted, press  to enter the interface of pattern selection (as shown in right figure).

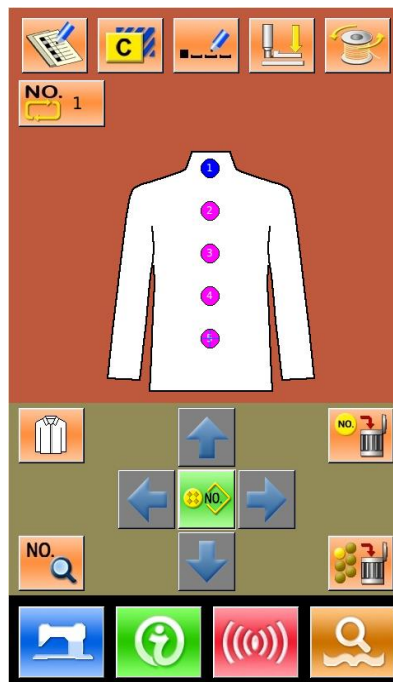

### ⑤ Pattern Selection

: Input number to inquire patterns

: Delete the pattern

: Shift to selection of patterns for continuous sewing

Select the proper pattern and press  to end the selection.

Press  to quit directly.

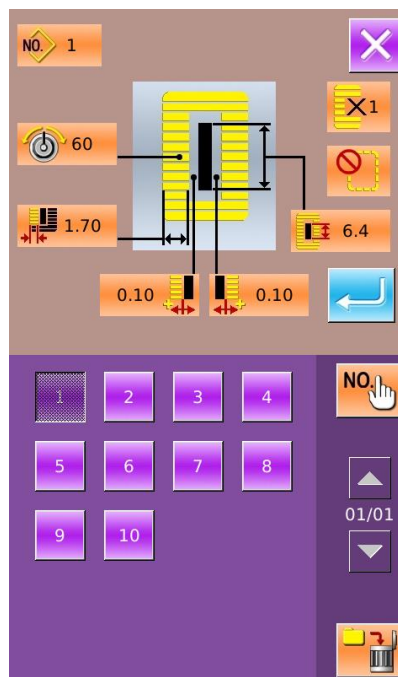

### ⑥ Change Sewing Data

Move the icon to the target position, press  to enter the interface for sewing data setting (as shown the figure below).

Press  to quit the relating sewing data change interface.



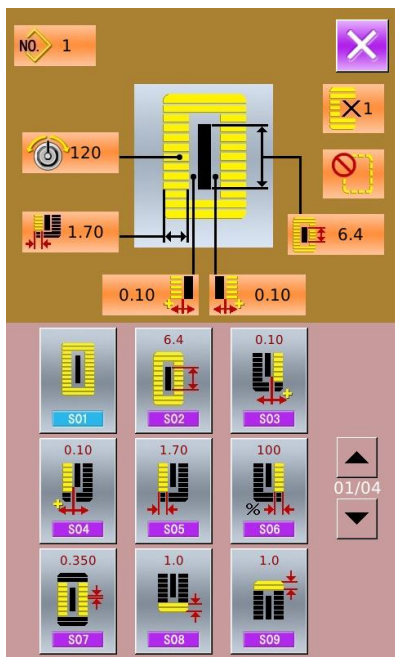

Left figure is the modification on sewing data of normal pattern. For specific operation, please take the section 4.10 Sewing Data Setting for reference.

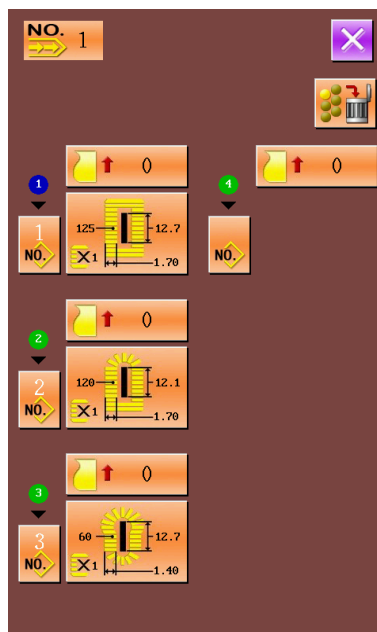

The right figure is the edition on the data of the continuous stitching. On specific operation, please refer to Continuous Sewing Data Input

### 6. 2. 5 Change Fabric

Press  to enter the interface for selecting the fabric (as shown in right figure).In this section, the user can modify the reference design in the interface of sewing data input.

Press  to quit; Press  to confirm the selection







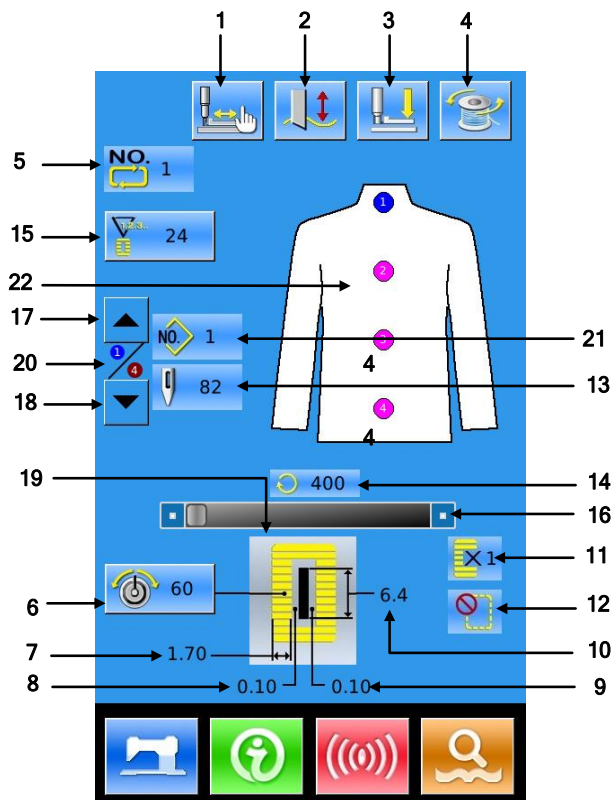



### 6.3 Cyclic Sewing Interface

Press  to enter the sewing interface (as shown in right)



#### 6.3.1 Function List

No.	Figures	Functions	Remarks
1		Trial Sewing	
2		Knife Function	Shift the knife activation
3		Threading (Presser Down)	
4		Winding	
5		Pattern Number Display	
6		Needle Thread Tension Setting	
7		Left Over-edges Width	
8		Left Width of Knife Groove	

No.	Figures	Functions	Remarks
9		Right Width of Knife Groove	
10		Length of Cloth Cutting	
11		Single Sewing/ Double Sewing	
12		Number of Basting	
13		Stitch Number	
14		Current Sewing Speed	
15		Counter Value  : Sewing Counter  : No. of piece counter	
16		Speed Setting	
17		Sewing Order Reverse	Return to the previous sewing order
18		Sewing Order Forward	Go to next sewing order
19		Sewing Shape	
20		Sewing Order at Work	
21		Pattern Number at Current Sewing	
22		Sewing Order	

### 6.3.2 Trial Sewing at Cyclic Sewing





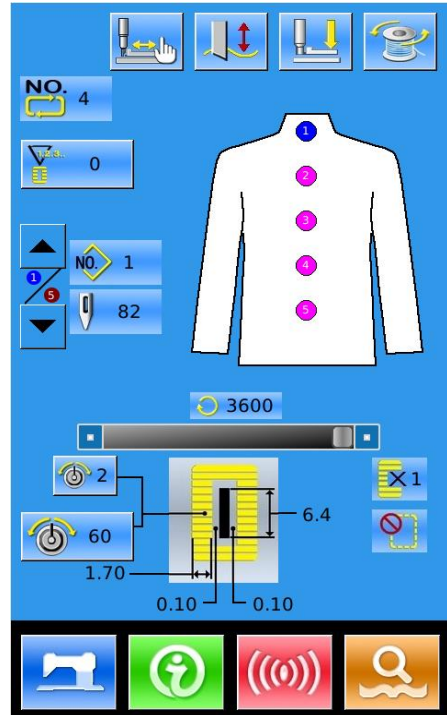





#### (1) Display Sewing Interface

At data input interface, press  , the background of screen will change to blue, and the system enters the interface of sewing.





#### (2) Display of Trial Sewing

In the sewing interface. Press  to enter the trial sewing interface (As Shown at Right):

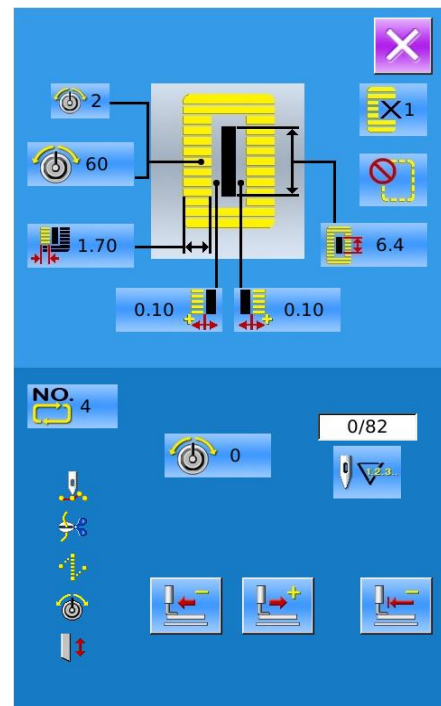
-  : Return to Origin
-  : Return
-  : Forward
-  : Tension at Stitch Point
-  : Current/ Total Stitch Number
-  : Sewing Order
-  : Thread Trimming Order
-  : Jump Feed Order
-  : Thread Tension Order
-  : Knife Driving Order



**(3) Start Trial Sewing**

By using , , and  to start trial sewing. Under this mode, step on the pedal switch to start the machine for sewing the leftover stitches

**(4) End Trial Sewing**

Press  to return to the sewing interface from trial sewing interface



# 7 Mode Setting

Press  to shift between the Data Input Interface and Mode Interface (as shown in the right figure), and the detailed edition and setting can be carried out under this interface.

Note: For some button, user has to hold  to open them.

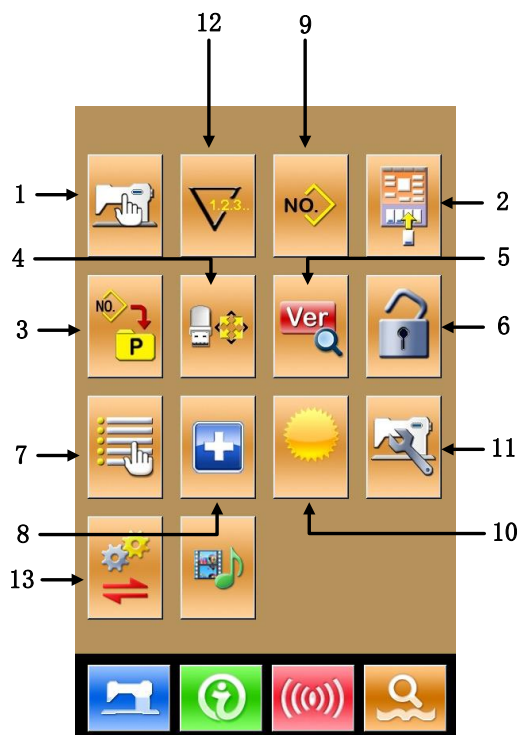

## 7. 1 Function List

No	Figure	Function	Remarks
1		Level 1 Parameter Setting	
2		Sewing Data Edition	
3		P Pattern Setting	
4		Initialization	
5		Software Version Inquiry	
6		Keyboard Lock	
7		User Management Setting	
8		Test Mode	
9		Sewing Type Setting	
10		Brightness Adjustment	
11		Level 2 Parameter Setting	
12		Counter Setting	
13		Parameter Back-up & Recovery	



## 7.2 Level 1 Parameter Setting

### ④ Set Parameter



Select  to enter the interface of Level 1 parameter setting (shown as the figure at right).



Press  to quit the setting interface

When some parameters are changed, the system will display the “Modified” in the parameter setting interface.

Select the parameter for changing; Then the system will enter the setting status. The parameters are separated as “Data Input Type” and “Selection Type”. Please refer to the example at below:

Select U01 and enter the interface below

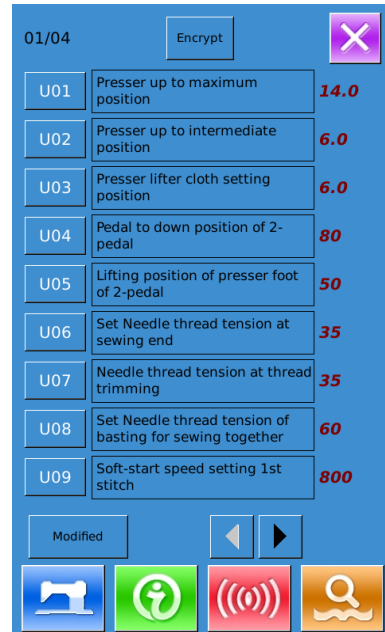
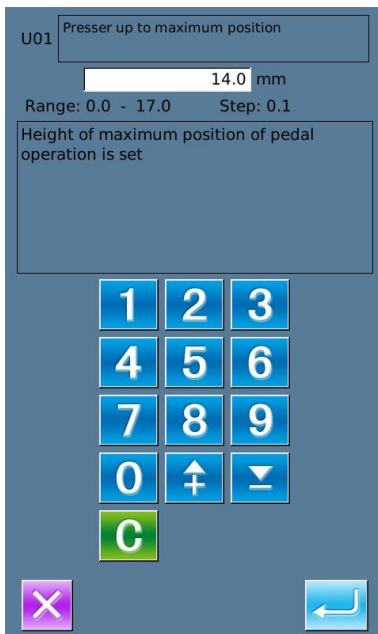



Select U19 and enter the interface below:



⑤ **Parameter Encryption**

A、 Press “Encryption” to enter the password input interface.

Press  to clear all the content

Press  to erase one figure at each pressing

B、 Input the right password to enter the interface for parameter encryption

Select the parameter for encryption

Press **【Select All】** to attach password to all the parameters

Press**【Reverse】** to select parameter for encryption in reverse way

Press **【Change】** to change the password, the default is the manufacturer ID

Press  to quit the encrypting function

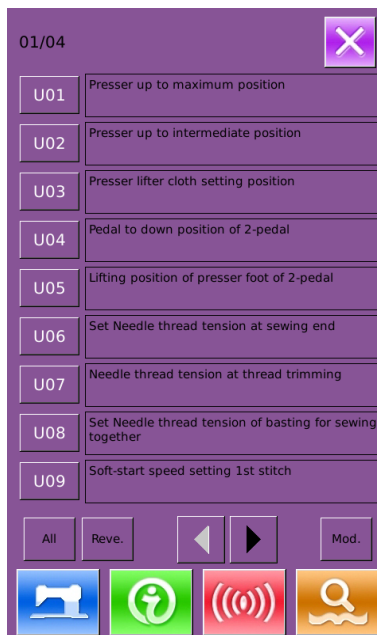
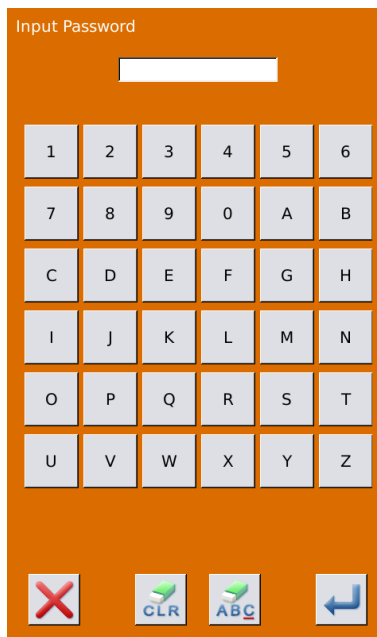

⑥ Check the changed parameters

A、 When parameter is changed, the system will display “Modified” key at parameter setting interface.

B、 In the parameter setting interface, press **【 Modified 】** to check the changed parameters.

At first, the system will ask user to input the password. For the operation at password input interface, please refer to the “A” at ②. After inputting the right password, user can enter the interface for inquiring changed parameters.

C、 Under the interface of changed parameter inquiry, user can find the list containing all the changed parameters with their current value and default value.

In that interface:

- Press **【 All Rest 】** will restore all the changed parameters to their default values
- Click Parameter Name, like **【 Presser Type 】** and then press **【 Select Rest. 】** to restore this parameter to the default value. User can select many parameters at here.
- Press Parameter Number, like **【 U14 】** to enter the parameter setting interface, where user can reset the parameter value.
- When the pages are more than one, user can use arrow key to turn the page.
- Press  to quit the interface.

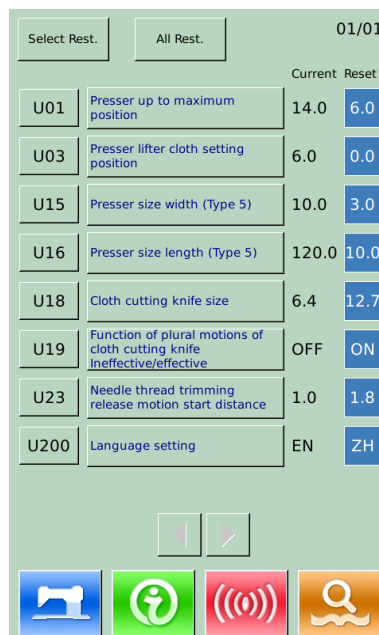
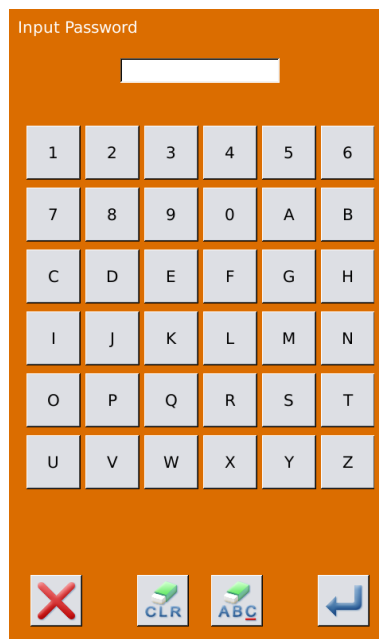

List of Level 1 Parameters

No.	Parameter	Range	Unit	Default value
U01	Presser up to maximum position Height of maximum position of pedal operation is set.	0~17.0	0.1mm	6.mm
U02	Presser up to intermediate position Height of intermediate position of pedal operation is set.	0~14.0	0.1mm	6.0mm
U03	Presser lifter cloth setting position Height of cloth at of pedal operation is set.	0~14.0	0.1mm	0
U04	Down position of 2-pedal (%)	5~95	1%	80%

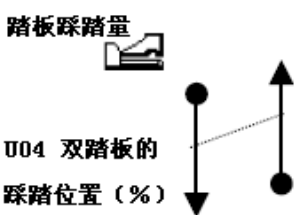
No.	Parameter	Range	Unit	Default value
	Set the operation of the 2-pedal			
U05	Lifting position of presser foot of 2-pedal Operation of 2-pedal is set  	5~95	1%	50%
U06	Set needle thread tension at sewing end	0~200	1	35
U07	Needle thread tension at thread trimming	0~200	1	35
U08	Needle thread tension at basting	0~200	1	60
U09	Soft-start speed setting 1st stitch	400~4200	100rpm	800rpm
U10	Soft-start speed setting 2nd stitch	400~4200	100rpm	800rpm
U11	Soft-start speed setting 3rd stitch	400~4200	100rpm	2000rpm
U12	Soft-start speed setting 4th stitch	400~4200	100rpm	3000rpm
U13	Soft-start speed setting 5th stitch	400~4200	100rpm	3600rpm
U14	Type of presser (Type 1, 2, 3, 5) 1: 25 x 4    2: 35 x 5 3: 41 x 5    5: User Defined	1, 2, 3, 5		Type 1
U15	Presser size width (Type 5) When U14 is set at type 5, user can input the width.	3.0~10.0	0.1mm	3.0mm
U16	Presser size width (Type 5) When U14 is set at type 5, user can input the length.	10.0~120.0	0.5mm	10.0mm
U17	Sewing start position (Feeding direction) Set the sewing start position to the presser. Set this item when starting position needs to move due to overlapped section or the like	2.5~110.0	0.1mm	2.5mm
U18	Cloth cutting knife size	3.0~32.0	0.1mm	12.7mm
U19	Function of plural motions of cloth cutting knife	ON、OFF		ON
U20	Thread Breakage Detection	ON、OFF		ON
U21	Selection of presser position at the time of ON of READY key Set presser foot position when READY key is pressed UP: Up DN: Down	UP、DN		UP
U22	Selection of presser position at sewing finish. Set presser foot position when sewing is completed. (only effective at single pedal type) UP: Up DN: Down	UP、DN		UP

No.	Parameter	Range	Unit	Default value
U23	Needle thread trimming release motion start distance Input the distance for needle thread trimmer motor to release the trimmer at sewing start.	0~15.0	0.1mm	1.8mm
U24	Bobbin thread trimming release motion start distance Input the distance for bobbin thread trimmer motor to release the trimmer at sewing start.	0~15.0	0.1mm	1.5mm
U25	Counter updating unit Update Unit in sewing counter	1~30	1	1
U26	Forbid Changes at Counter	ON、 OFF		OFF
U27	Operation of machine at counter reaching set value	ON 、 OFF		OFF
U49	Light Brightness Adjustment	0-5	1	0
U50	Voice of Buzzer OFF: Buzzer off PAN: Control Panel Voice available ALL: Voice of Control Panel and buzzer available	OFF、 PAN、 ALL		ALL
U100	Back Light Auto Off OFF: No Auto Off ON: Auto Off	ON、 OFF		OFF
U101	Back Light Off Wait Time	1~9	1	3s
U102	Volume	30-63	1	50
U200	Language Setting	Chinese, English, Turkish		Chinese
U201	Select Language at Power-on	ON、 OFF		OFF

### 7.3 Level 2 Parameters Setting

#### ④ Set Parameter

In the interface of Mode Setting Level 3, press  to enter the interface for setting parameters of Level 2 (as shown in the right figure). For the operation methods, please take the description in 7.2 Level 1 Parameter Setting for reference

When some parameters are changed, the system will display the “Modified” in the parameter setting interface.

Press  to quit the parameter setting interface

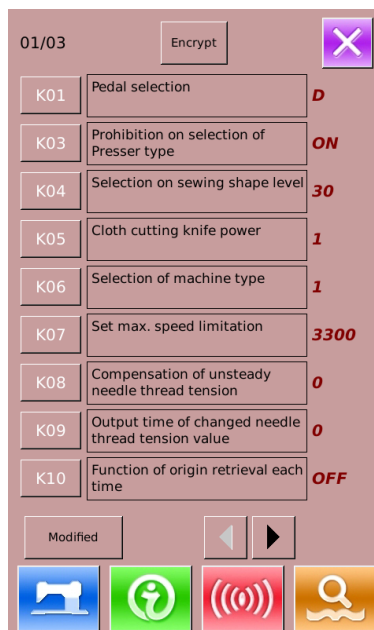

#### ⑤ Parameter Encryption

For the steps of the parameter encryption, please refer to “7.2 Level 1 Parameter Setting”.

Press  to quit the parameter encryption interface.

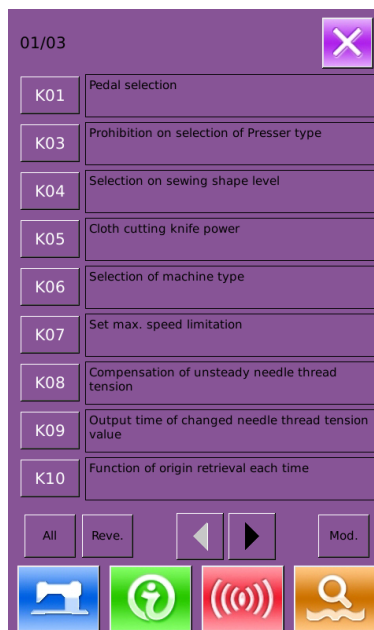

⑥ Check the changed parameters

When parameter is changed, the system will display “Modified” key at parameter setting interface

In the parameter setting interface, press **【Modified】** to check the changed parameters.

User can also reset the parameters here.

For the specific operation, please refer to “7.2 Level 1 Parameter Setting”

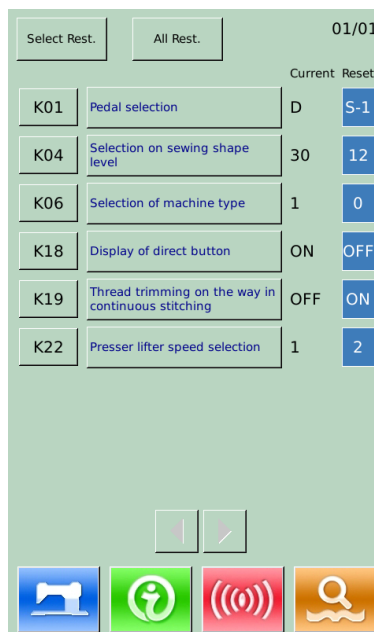

List of Level 2 Parameter

No.	Parameter	Range	Unit	Default value
K01	Pedal Selection D: Double Pedal S-1: Single Pedal (No middle position) S-2: Single Pedal (With middle position)	D、 S-1、 S-2 S-3 S-4 S-5		S-3
K03	Prohibition on selection of Presser type OFF: Prohibit to change ON: Permit to change	ON、 OFF		ON
K04	Selection on sewing shape level ( 12/20/30)	0~2		0
K05	Cloth cutting knife power Set output power of cloth cutting knife	0~3	1	0
K06	Selection of machine type (0-Standard type, 1-Non-oil Type)	0~1	1	0
K07	Set max. speed limitation When K06 Selection of machine type is set to non-oil type, max speed is automatically limited to 3,300 rpm. ※Protected by password	400~4200	100rpm	3600rpm
K08	Compensation of unsteady needle thread tension Output value of needle thread tension is wholly compensated.	-30~30	1	0
K09	Output time of changed needle thread tension value When data related to needle thread tension is changed, the changed value is output only at the set-up time.	0~20	1s	0
K10	Search origin at each time Search origin at each sewing end OFF: NO	OFF、 1、 2		OFF

No.	Parameter	Range	Unit	Default value
	1: After Sewing End 2: After Cycle End			
K11	Needle up by reverse run When U01 Presser lifter maximum position is set to 14.0 mm or more, needle can be lifted by reverse run automatically and the machine stops. Prohibition of the motion can be set OFF: Forbidden ON: Permitted	ON、OFF		ON
K12	Set knife solenoid lowering time	25~100	5ms	35
K13	Set knife solenoid lifting time	5~100	5ms	15
K14	Knife cylinder lowering time (Optional)	5~300	5ms	50
K15	Y-feed motor origin compensation	-120~400	1 Pulse (0.025mm)	0
K16	Needle-rocking motor origin compensation	-10~10	1 Pulse (0.05mm)	0
K17	Presser lifter motor origin compensation	-100~10	1 Pulse (0.05mm)	0
K18	Display of direct button OFF: Not Display ON: Display	ON、OFF		OFF
K19	Thread trimming on the way in continuous stitching In case of prohibited, jump feed setting becomes invalid, and the registered pattern is sewn at the same position. Then multi-sewing is possible OFF: Prohibition ON: Permission	ON、OFF		ON
K20	Change of cloth cutting knife return power This item sets output power at the time of returning the cloth cutting knife.	0~3	1	0
K21	Release amount of bobbin thread trimmer at the start of sewing This item sets the amount of releasing the bobbin thread trimmer at the start of sewing。	1~15	1Pulse	8
K22	Presser lifter speed selection	1~3	1	1
K25	Cutting Origin Adjustment	-100-100	1	0
K28	Transfer Speed Setting	1-5	1	1
K29	Upper Thread Trimming Speed Setting	0-1	1	1
K150	Safty Switch	0-1	0	1
K189	Adjustment of Thread-breakage Detection Sensitivity	1~10	1	3
K190	Adjustment on sensitivity of button	1~5	1	3
K200	Restore to original parameters ※ Protected by Password			
K201	Main Control Programming Site	主控烧录地址 0xA0000:655360 0xB0000:720896 0xC0000:786432 0xD0000:851968	655360-917504	1



No.	Parameter	Range	Unit	Default value
		0xE0000:917504		
K202	Machine Type Setting	0: 1790 1:1796	0-1	0

## 7. 4 Counter Setting



Press  to enter the interface for counter setting(as shown in the right figure)

Operation Steps:

### ⑤ Select Sewing Counter Type

Select Sewing Counter or No. of Pcs Counter

### ⑥ Set the Current Value and Setting Value

At the selected type, press the “Current” or “Setting” to perform the relating operation.

### ⑦ Select Up Counter or Down Counter

At the selected type, please press “Up” and “Down” to perform the relating operations.



Press  to quit counter setting interface



Press  to finish setting and quit.

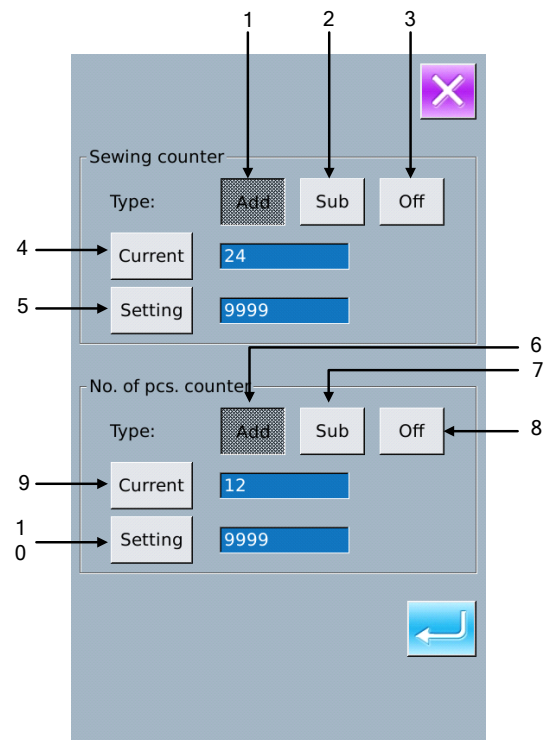

### Sewing UP Counter :

Every time the sewing of one shape is performed, the existing value is counted up 1. When the existing value is equal to the set value, the interface of counter exceed warning will be displayed. Press  to restore the existing value to 0

### Sewing DOWN Counter :

Every time the sewing of one shape is performed, the existing value is counted down 1. When the existing value is reached to "0", the interface of counter exceed warning will be displayed. Press  to restore the existing value to the set value.

### No of piece UP counter :

Every time a cyclic sewing or a continuous sewing is performed, the existing value is counted up 1. When the existing value is equal to the set value, the interface of counter exceed warning will be displayed. Press



to restore the existing value to 0

#### **No of piece DOWN counter:**

Every time a cyclic sewing or a continuous sewing is performed, the existing value is counted down 1. When the existing value is reached to "0", the interface of counter exceed warning will be displayed. Press  to restore the existing value to the set value.

#### **⑧ Turn Off Counter**

At the selected counter type, press "Off" to turn off the counter

### **7. 4. 1 Functions**

<b>No.</b>	<b>Function</b>	<b>Remarks</b>
1	Sewing Add Counter	
2	Sewing Down Counter	
3	Sewing Counter Off	
4	Set Current Sewing Counter Value	
5	Set the Setting Value of Sewing Counter	
6	No.of Pcs Add Counter	
7	No.of Pcs Down Counter	
8	No.of Pcs Counter Off	
9	Set Current No.of Pcs Counter Value	
10	Set the Setting Value of No.of Pcs Counter	

### 7. 5 Settings on User Management

Register parameters which are frequently used to Management button and use them.



Press to enter user management setting interface (shown as the right figure)

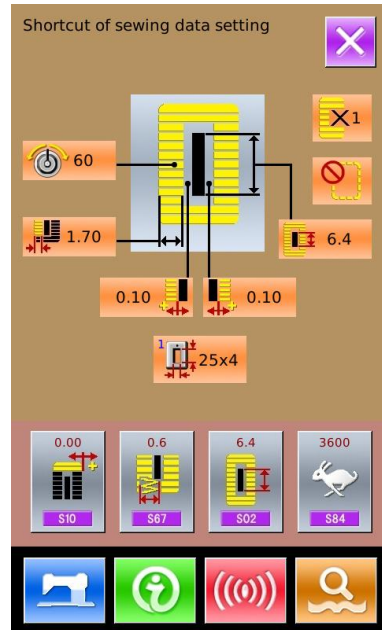

#### ① Register to Management Button

The management buttons can be registered up to four buttons. Four management register buttons are displayed on the screen. When the button located on the position you desire to register is pressed, the sewing data selection screen is displayed. (as shown in right figure)

Press  to quit the interface for setting the customer management.

Select the sewing data you wish to register,

press  to end the operation of registration. The newly registered sewing data will be displayed on the user management button

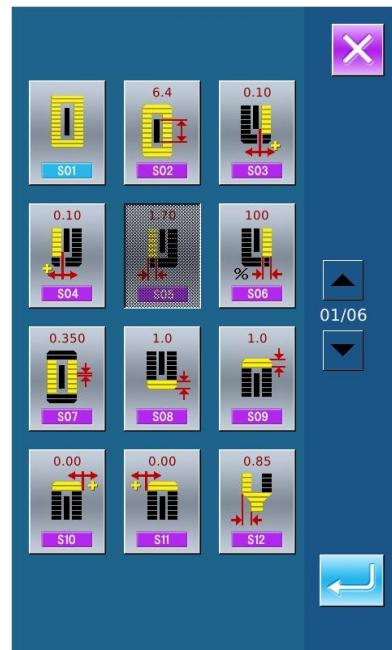

#### ② Original State of Registration

The following items have been registered in order (from the left to the right) at the time of your purchase



S07 : Pitch at parallel section;

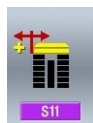

S11 : Compensation of bar-tacking width, left



S10 : Compensation of bar-tacking width, right;



S57 : Setting of needle thread tension at the start of sewing

## 7.6 Edition of Sewing Data

Some sewing data can be set to be opened, press 

to enter the interface of sewing data edition under the Mode Setting Level 2 (as shown in the right figure)





S20 : Sewing data is opened



S20 : Sewing data is closed

Select the sewing you wish to edit. When the button is pressed, the interface will be shifted between reverse

display/non- display. After pressing  , the user can confirm whether the sewing data item is in state of opening

Press  to quit the Sewing Data Edition Interface.

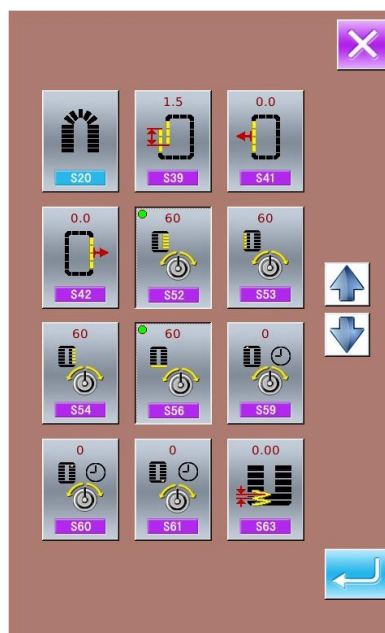

## 7.7 Change Sewing Mode



Press  to enter the interface of sewing type selection (as shown in the right figure).



: Normal Sewing





: Continuous Sewing



: Cyclic Sewing

After confirming the sewing type, press  to end the

operation. Press , then the data input interface of the selected sewing type is displayed.

Press  to quit and the original sewing remains.

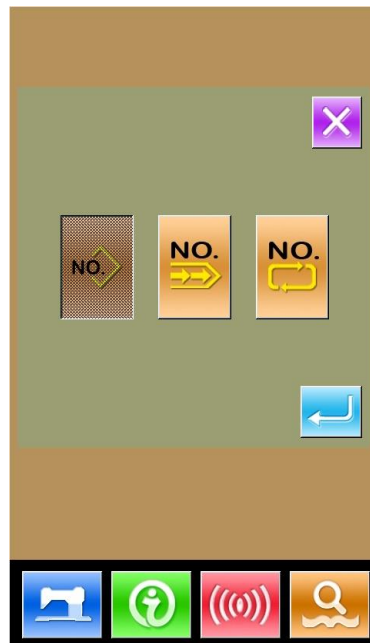

## 7.8 Register Pattern to Direct Button

Register the pattern numbers which are frequently used with the direct buttons for use.



Press  to enter the interface of direct button registration (as shown in right figure).



Press  to quit the Pattern Registration Function

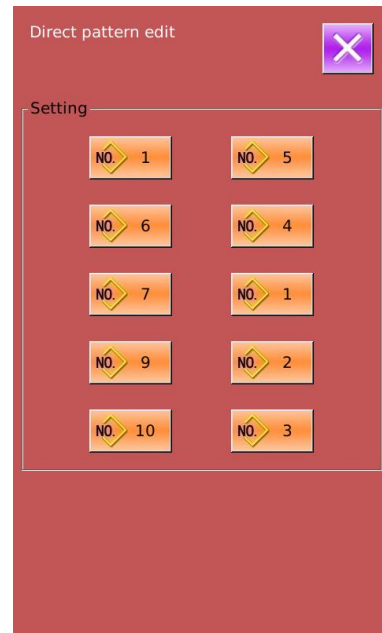

10 pattern numbers can be registered to the direct buttons at most. On 10 displayed direct buttons, the user presses the button he wishes to register, and then enters the pattern select interface. (as shown in the right figure)

The file in blue is the file in VDT format

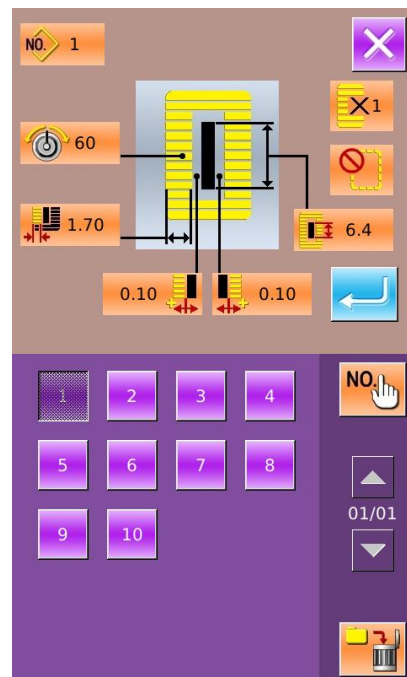

: Pattern Inquiry



: Delete Current Registered Pattern



: Confirm



: Quit

## 7.9 Test Mode

In the Mode Setting Level 2 interface, press  to enter the interface of Test Mode (as shown in right) .

The function of each figure is shown as below:

No.	Name
<b>A</b>	I01 Needle thread trimming
<b>B</b>	I02 Down thread trimming
<b>C</b>	I03 Input inspection
<b>D</b>	I04 Inspection of LCD display
<b>E</b>	I05 Correction of touch panel
<b>F</b>	I06 Output inspection
<b>G</b>	I07 Speed test
<b>H</b>	I08 Continuous running

Press  to quit Test Mode

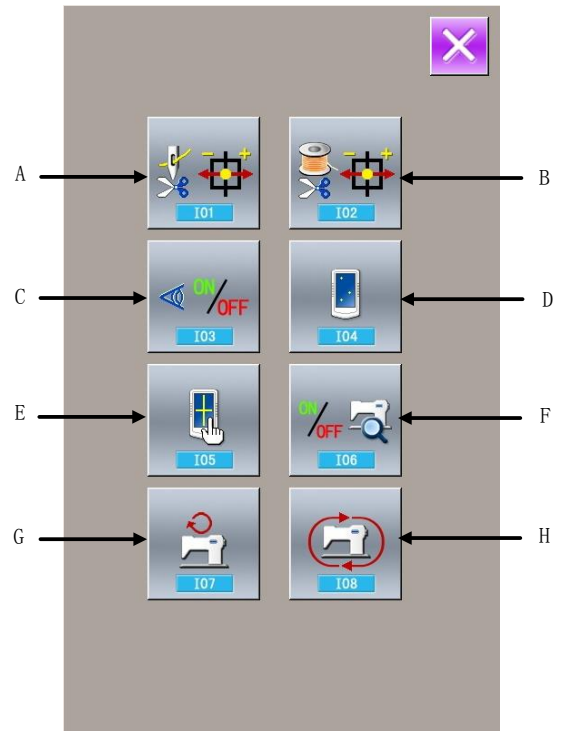

### (1) Adjustment of Needle Thread Trimming

#### ① Adjusting Method

In the interface of Test Mode, press  (I01 Needle thread trimming) to enter the adjustment interface of needle thread trimming (as shown in the right figure):

#### Needle Thread Trimming:

No.	Name	Range	Initial value
<b>A</b>	<b>Origin position</b>		
<b>B</b>	Initial position	-10~10	0
<b>C</b>	Releasing position	-95~-80	-86
<b>D</b>	Position for trimming	0~20	10
<b>E</b>	Post-trimming position	30~50	40

#### ② Select the mode position you wish to adjust

Press  G to select the positions (A, B, C, D) for

adjustment, then press the  /  key to adjust the

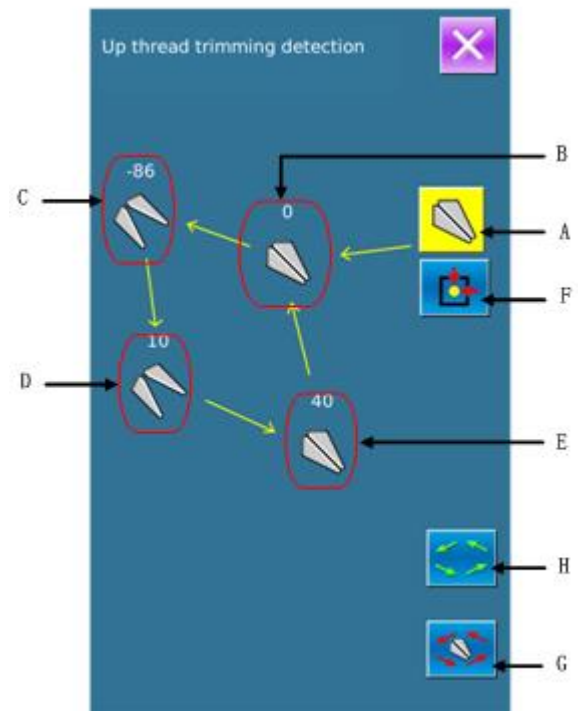

necessary value, at last press  F to return to the origin.

⑦ Press  to return to the Test Mode Interface

(2) Adjustment of Down Thread Trimmer

① Adjusting Method



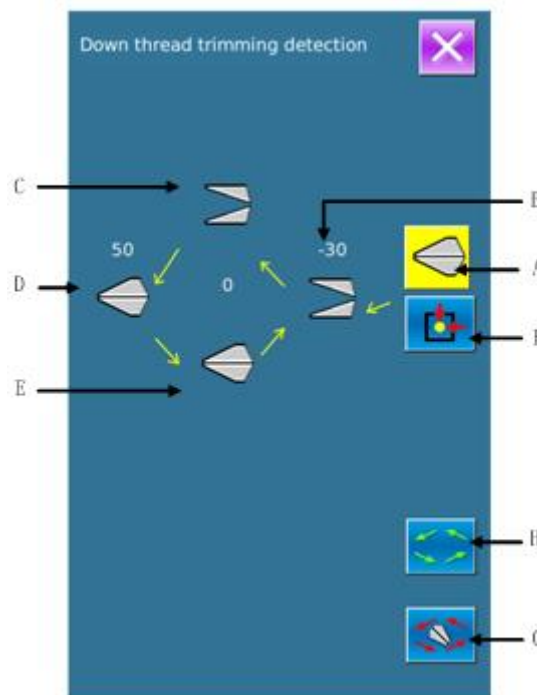

In the interface of Test Mode, press  (I02 Down thread trimming) to enter the adjustment interface of Down thread trimming (as shown in the right figure):

Down Thread Trimming:

No.	Name	Range	Initial value
A	Origin position		
B	Releasing position	-40~-15	-30
C	Position for trimming	-10~10	0
D	Post-trimming position	40~60	50
E	Initial Position	-10~15	0



⑥ Select the mode position you wish to adjust

Press  G to select the positions (A, B, C, D) for adjustment, then press the  /  key to adjust the necessary value, at last press  F to return to the origin

Press  to return to Test Mode Interface.

(3) Input Signal Test Method

In the interface of Test Mode, press  (I03 Input Inspection) to enter the interface of input inspection interface (as shown in right). Users can confirm the input status of each switch and sensor.

**ON:** Turn On

**OFF:** Turn Off

A: mount of pedal pressed

B: Pedal Sensor

C: Thread-breakage Detection

D: Knife Sensor



- E: Head Tilt Sensor
- F: Stop Switch
- G: Needle Rocking Sensor
- H: Semi-lunar Sensor of Sewing Machine
- I: Y Feeding Origin
- J: Presser Origin
- K: Needle Thread Trimming Motor Origin
- L: Bobbin Thread Trimmer Motor Origin

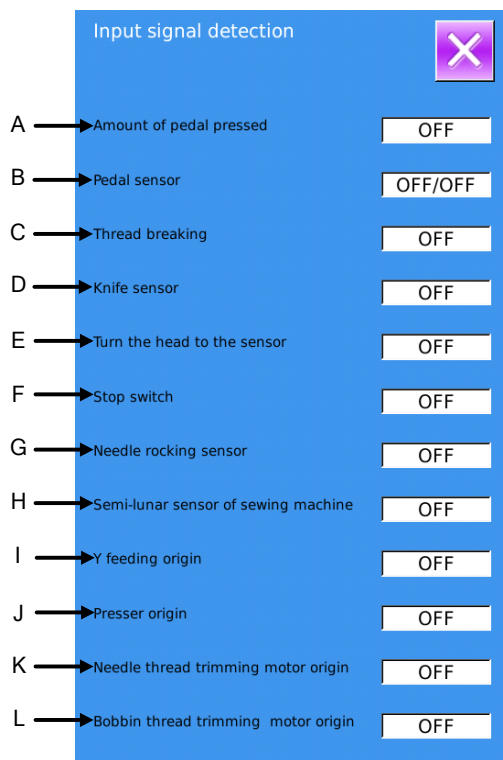

**(4) Inspection of LCD Display**





In the interface of Mode Inspection, press  (I04 Inspection of LCD Display) to enter the interface of LCD Display Inspection (as shown in right figure). Check whether the LCD fades in that status.

Touch the panel to have the screen display in the cycle of “Blue — Black — Red — Green — White”.

Press  to quit the interface of LCD Display Inspection



### (5) Correction of Touching Panel

A、 In the interface of Mode Inspection, Press  (I05 Correction of Touch Panel). Then system will hint user 【Enter Touching Panel Correction Mode?】. Press  to enter the interface for Touch Panel Correction (as shown in right figure). Press  to quit the correction status.

B、 Because the corrections for five spots are needed, the user had better click the cross icon on the screen with tools like touching pen. After the correction, the system will tell user that this operation is successful or not.

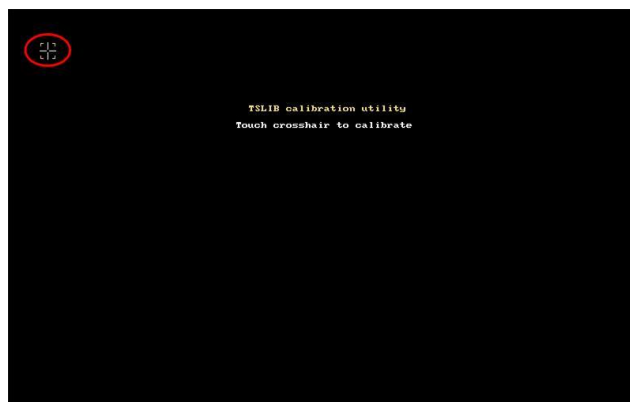



※ During the correction, please do perform the operation according to the positions of crosses. Otherwise, the touching panel will be unable to work normally after the correction.

### (6) Output Inspection

In the interface of Mode Inspection, Press  (I06 Output Inspection) to enter the interface of Output Inspection (as shown in the right figure). The following output status of the solenoid can be checked under that interface.:

- A: Needle-rocking Motor Test
- B: Presser Motor Test
- C: Bobbin Thread-trimming Motor Test
- D: Cloth-feeding Motor Test
- E: Needle Thread Motor Test
- F: Tension Solenoid
- G: Knife Solenoid

- When user presses A~E, the system will display . Press【+】and【-】to display the motor origin test status.
- At user pressing F~G, the corresponding solenoid will move
- Press  to quit output inspection interface

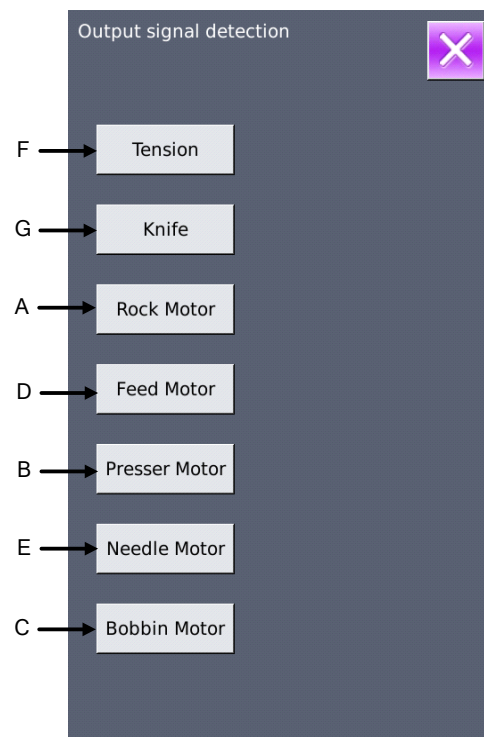

※ Attention: Sewing machine will perform relating actions.

### (7) Speed Test

#### ① Interface for Speed Test

In the interface of Mode Inspection, Press  (I07speed test) to enter the interface for Speed Test (as shown in right figure). The speed of main shaft motor can be tested in that interface.

Press  to quit the speed test interface.

#### ② Continuous running setting

Press “+” & “-” to set the speed of the main shaft motor.

Press , then the motor will run at the set speed. At this moment, the actual tested speed is displayed in the interface.

Press  to stop the machine.

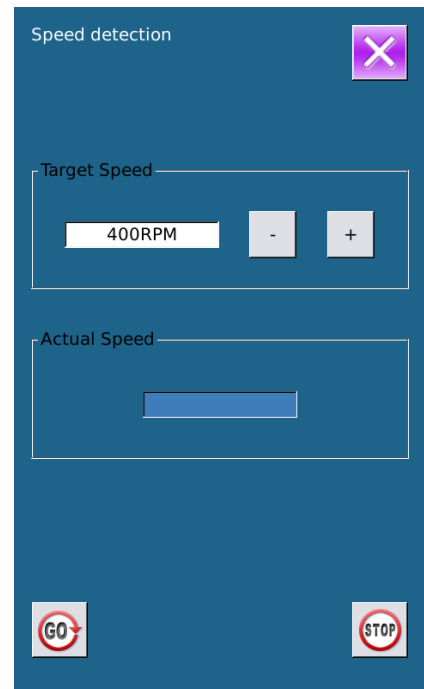

### (8) Continuous Running

#### ① Display the interface for continuous running

In the interface of Mode Inspection, Press  (I08 continuous running) to enter the interface of continuous running (as shown in right figure).

- A: Action interval
- B: Origin Detection

Press  to quit that interface.



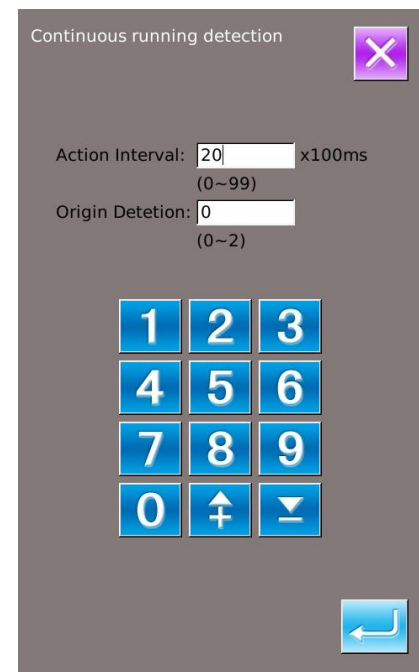

#### ② Continuous running setting

Click the columns under the interface of Continuous Running to set the Action interval and Origin Detection. Set the value with the number keys.

Press  and step the pedal to start the continuous running. During the running, user can use the pause switch to stop machine or he can stop machine by stepping the pedal or pressing pause switch at action end



### 7. 10 Brightness Adjustment

In the Mode Setting Level 2 interface, press  to enter the interface for brightness adjustment (as shown in right figure), the brightness value can be adjusted from 20 to 100 by pressing  or , it also can be adjusted by inputting the value via keyboard. Press  to finish the input. Press  to quit that interface

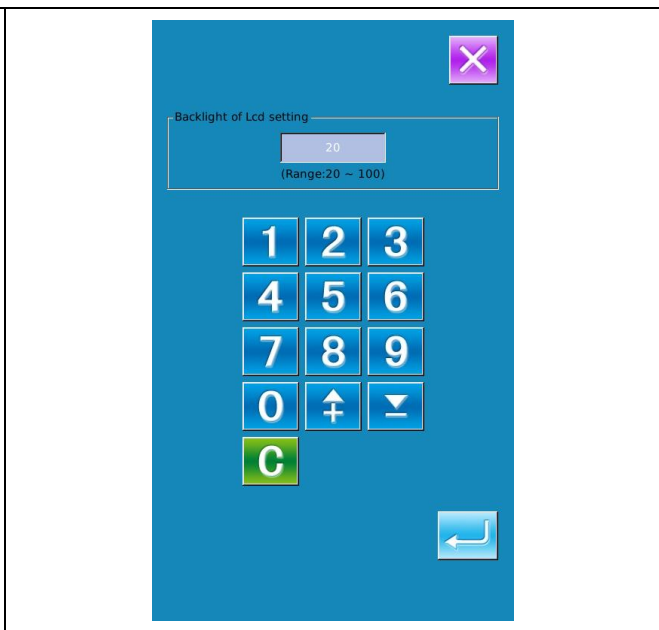



### 7. 11 Operation of Keyboard Lock

In the Mode Setting Level 2 interface, press  to enter the interface of Keyboard Lock Setting.

#### ① Lock the keyboard

 : Keyboard unlocked

 : Keyboard locked

Press  and  to lock the keyboard. Press  to quit this interface

#### ② Display of locking keyboard status

Close the interface of parameter setting mode, and return to the data input interface, like right figure. We

can see there is a figure to show the locking status  under the pattern number. Only can the available figures shown under the status of keyboard locking.

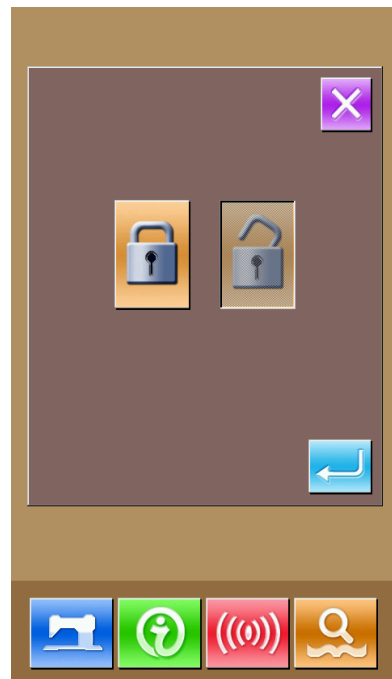

### ③ Scope of locking keyboard

#### 1. Normal sewing data input interface:

- 7) Pattern Registration
- 8) Pattern Copy
- 9) Pattern Naming
- 10) Customer Management
- 11) Presser Selection
- 12) Shape and Relevant Sewing Data

#### 2. Normal Sewing Interface:

- 3) Counter Setting
- 4) Needle Thread Tension Setting

#### 3. Continuous Sewing data input interface:

- 7) Pattern Registration
- 8) Pattern Copy
- 9) Pattern Naming
- 10) Cloth Feeding Amount
- 11) Deletion
- 12) Pattern Sewing Data

#### 4. Continuous Sewing Interface:

- 3) Counter Setting
- 4) Needle Thread Tension Setting

#### 5. Cyclic Sewing Data Input Interface:

- 7) Pattern Registration
- 8) Pattern Copy
- 9) Pattern Naming
- 10) Deletion
- 11) Delete All
- 12) Sewing Fabric

#### 7) Sub-pattern Registration

#### 6. Cyclic Sewing Interface:

- 3) Counter Setting
- 4) Needle Thread Tension Setting

#### 7. Parameter Setting Mode:

- 4) Parameter Level 1
- 5) Parameter Level 2
- 6) P Pattern Edition
- 4) Customer Management
- 5) Sewing Data Edition
- 6) Inspection Mode
- 7) Counter Edition

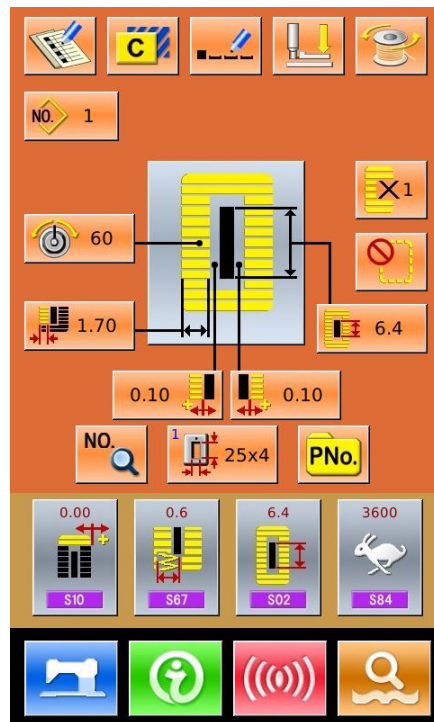

## 7. 12 Initialization



Press  to enter the interface for setting the keyboard lock.

In this interface, user can operate:

- U Disk Initialization
- Memory Initialization
- Customized Initialization

Press the relating functions keys and enter the corresponding interface.

Press  to quit.

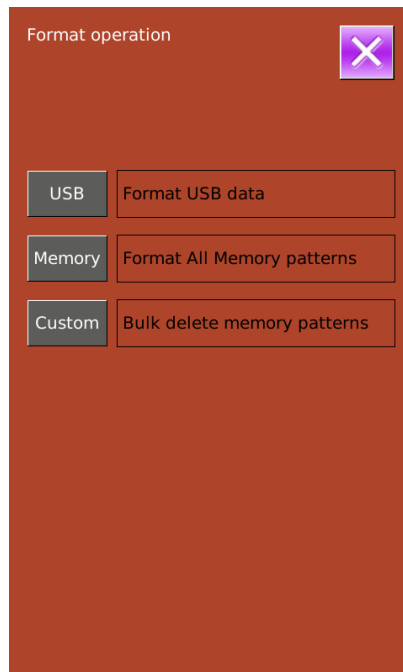

### ⑤ Press “USB” to Initialize U Disk Files

Press  to initialize all the U disk files

Press  to quit U disk initialization

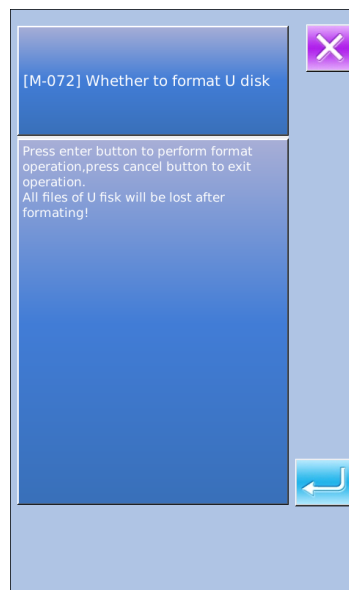

⑥ Press “Memory” to initialize memory patterns

The following patterns can be initialized:

- Normal Pattern
- Continuous Sewing Pattern
- Cyclic Sewing Pattern
- Registered P Pattern

Press  to initialize all the files in memory

Press  to quit

※ **Caution! This operation will delete all the patterns within the memory!**

⑦ Press “Custom” to perform the batch deletion

In this interface, the system will display all the pattern files within the memory. Click the corresponding button to perform the batch deletion.

Operations at this function:

- A. Use “Up Arrow”, “Down Arrow” to turn the page
- B. Use the following three operations to select patterns

➤ Press  to select all the patterns

➤ Press  to select pattern in contrary way

➤ Input pattern number

C. Press  to delete the patterns in batch

D. Press  to quit Initialization Interface

※ **The files with blue mark are in vdt format.**

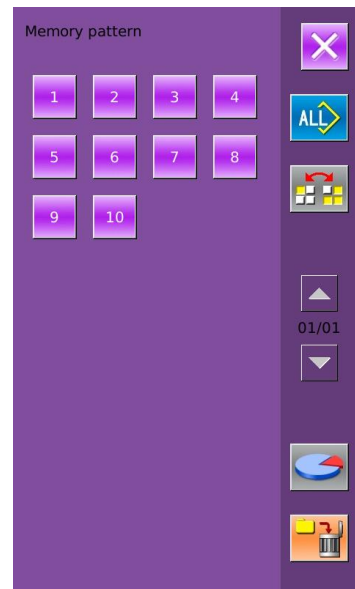
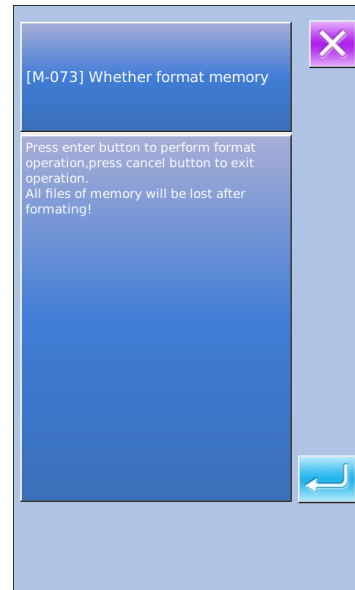

⑧ Under the Interface of Custom Initialization,

press  to display the free room of the memory and the number of patterns in each format.

Press  to return to the upper interface.

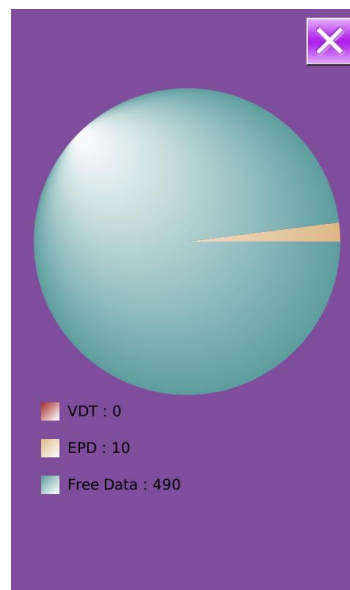

### 7. 13 Parameter Back-up & Restoration

In order to use in future, user can save 8 groups of U level parameters according to needs

In setting mode level 2, press  to enter the interface of parameter back-up & restoration, as shown in right:

Clear: Clear all the customized parameters that are saved.

Save: Save current parameters

Restore: Restore the current parameters

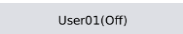
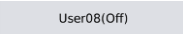
① Click and key among  ~  to set the position for saving the parameter. And then press 「 Save 」 to save that parameter.

② Check the content on「User xx(On/Off)」. If 「On」 is displayed in bracket, that means this position has the user parameter, for an example .

③ Select the button with parameters, press 「 Restore 」 to reload the corresponding parameter values

④ Press 「 Clear 」 to delete all the saved parameters.

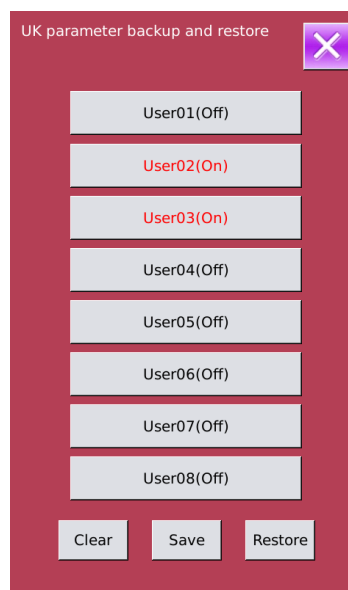



## 8 Communication

At Communication, user can perform the following functions:

- Download the sewing data made at other sewing machines or produced by the pattern-designing software to the sewing machine;
- Load sewing data to U disk or computer
- Load parameters from U disk
- Input the parameters within the operation panel to U disk
- Update the software within the operation panel

### 8.1 About the Available Data

The following two kinds of sewing data are available for operation; please check their formats in the form below:

Name	Suffix	Content
Vector Data	[0-9][0-9][1-9].vdt	Needle entry point data
Parameter Data	[0-9][0-9][1-9]. epd	Sewing shape designed in sewing machine.

When saving data to the U disk, user needs save it to the DH\_PAT folder. Otherwise, the file is unable to be read.

### 8.2 Operations

#### ④ Display the Communication Interface

In the data input interface, press  to display the communication interface.

#### ⑤ Select the relating operations

The following three kinds of functions can be selected in this interface:

- Pattern Transfer
- Parameter Transfer
- Software Update

Click the corresponding figure to perform the operations

#### ⑥ Press to quit the Communication

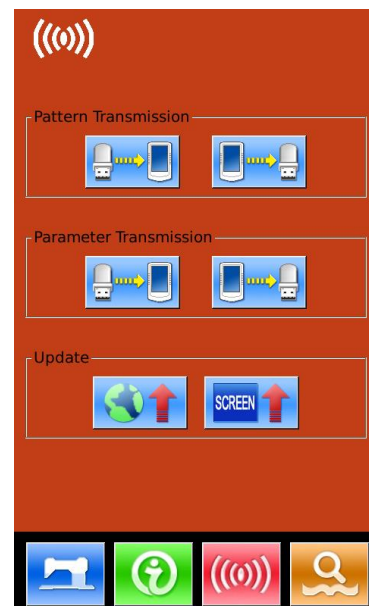

## 8.3 Pattern Transfer

### ④ Display the Communication Interface

In communication interface, press:

A: Input patterns from U Disk to Operation Panel

B: Output patterns from Operation Panel to U Disk

Path of U Disk: DH\_PAT

※ **When inputting patterns from U disk, user has to save the pattern into the DH\_PAT in the U disk.**

※ **When outputting patterns from operation panel, user has to save the pattern into the DH\_PAT in the U disk**

※ **Naming Method of Patterns within U Disk**

When inputting patterns from U disk, user needs follow the naming rule at below::

**File Name: 3 figures, 001~500**

**Suffix: epd、vdt**

**Example:**

**Right Names: 001.epd、100.vdt、003.EPD、102.VDT**

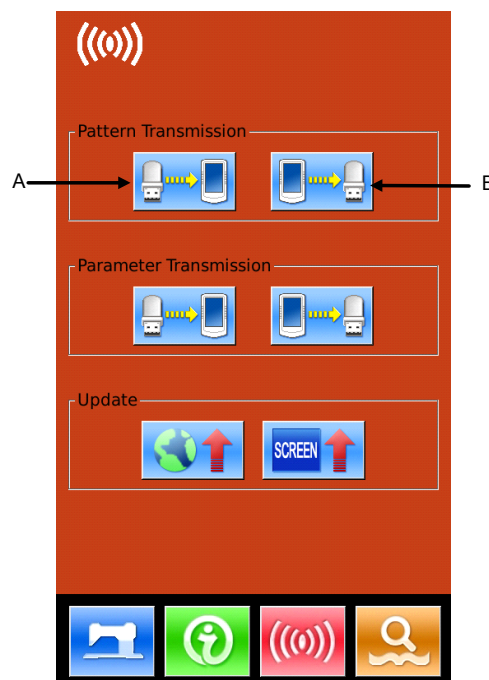

**Other naming methods are wrong, which can not be recognized by machine**





⑤ Press button A to enter the interface for inputting patterns from U Disk

A、Use【Up Arrow】，【Down Arrow】to turn the page

B、Use these three methods to select patterns

- Press  to select all the patterns
- Press  to select in contrary way
- Input Pattern Number

C、Press  to finish pattern input

D、Press  to delete the selected pattern

E、Press  to quit Communication Interface

F、Press  to display the interface shown at right.

Input the pattern number for saving;

Press  to copy the selected pattern within U Disk and save it to the pointed pattern number and return to the upper interface

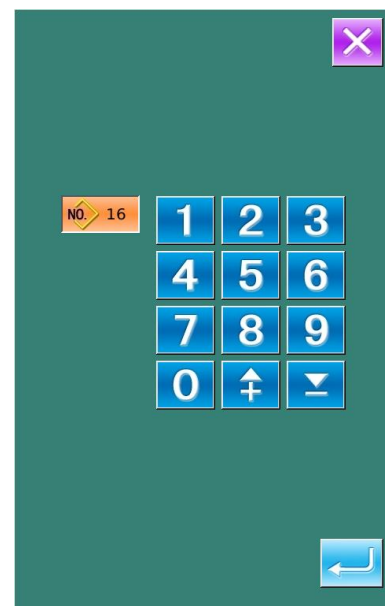
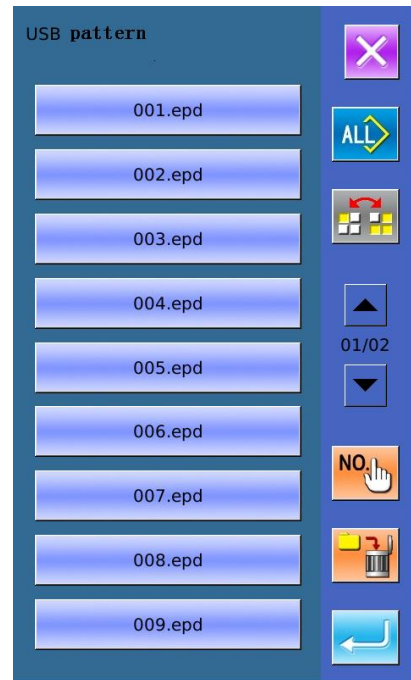

Press  to quit.





⑥ Press Button B to enter the interface for inputting patterns to U Disk.

A、 Use 【Up Arrow】 , 【Down Arrow】 to turn the page

B、 Use these three methods to select patterns

- Press  to select all the patterns
- Press  to select in contrary way
- Input Pattern Number

C、 Press  to delete the selected pattern

D、 Press  to finish pattern output

E、 Press  to quit Communication Interface

F、 In this interface, press  to display the free room of the memory and the number of patterns in each format.

※ The files with blue mark are in vdt format

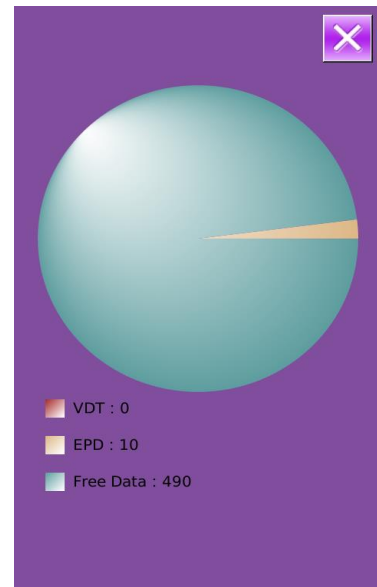
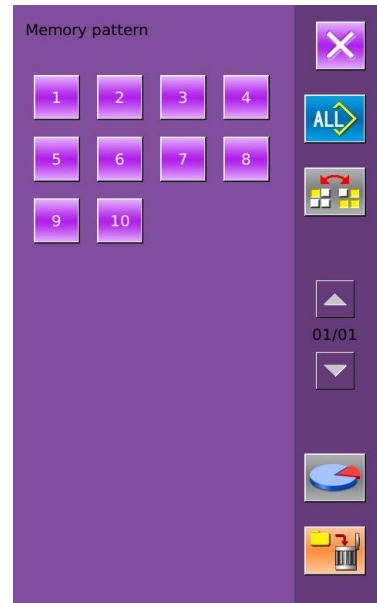

## 8. 4 Parameter Transfer

### ④ Display the Communication Interface

In communication interface, press:

A: Input parameters from U Disk to Operation Panel

B: Output parameters from Operation Panel to U Disk

- ※ When inputting patterns from U disk, user has to save the parameters into the DH\_PARA in the U disk with name PS\_Param.
- ※ When outputting patterns from operation panel, user has to save the parameters into the DH\_PARA in the U disk with name PS\_Param.
- ※ The parameter file is the binary file, which is operated on the control panel. User can not change that file manually on PC, or the file may be damaged.

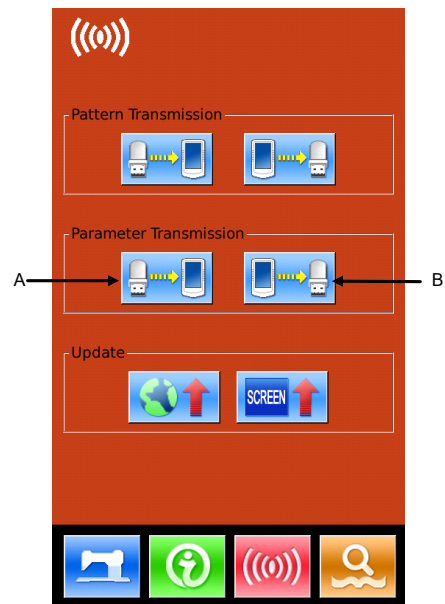



### ⑤ Press Button A to Input Parameters from U Disk to Operation Panel

A、 Press  to input the parameters and quit

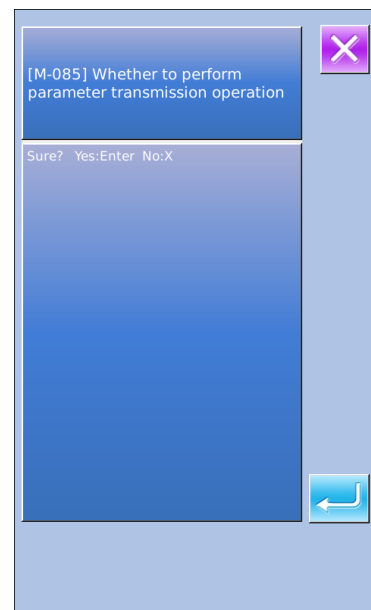
B、 Press  to quit directly.



⑥ Press Button B to Output Parameters to U Disk

- A、 Press  to output parameters from operation panel to U disk and quit
- B、 Press  to quit directly

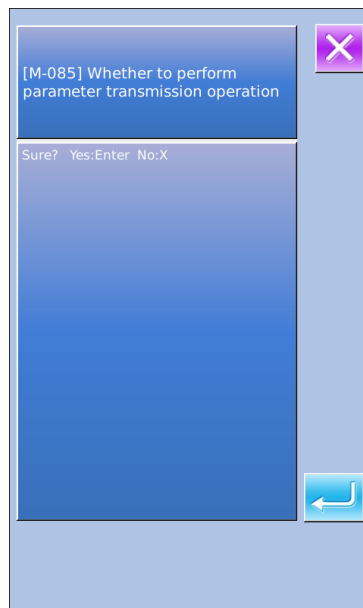

## 8.5 Software Update

① Display the Interface

In Communication interface, press A to enter Software Update Interface

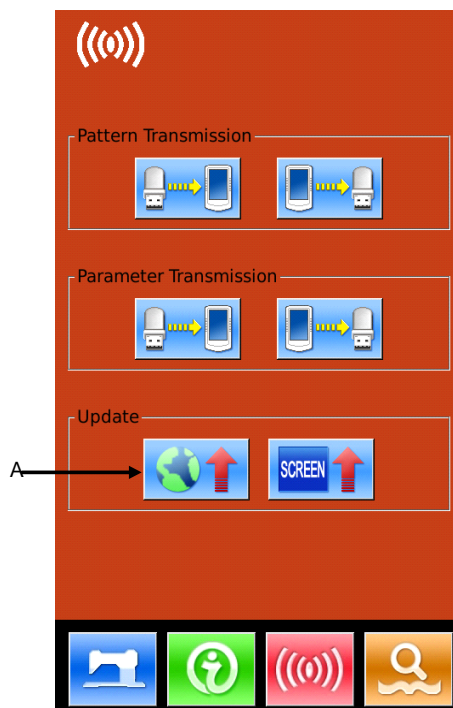

## ② Update Selection

The software update contains:

- ◆ Operation Panel Software
- ◆ Icon
- ◆ Font
- ◆ Power-on Screen

Press  and  to turn the page

A、 Press  to finish the selected update and quit

B、 press  to quit directly

C、 User can select several items for update at same time. The system will perform the update according to the order

D、 After the update, please restart the machine

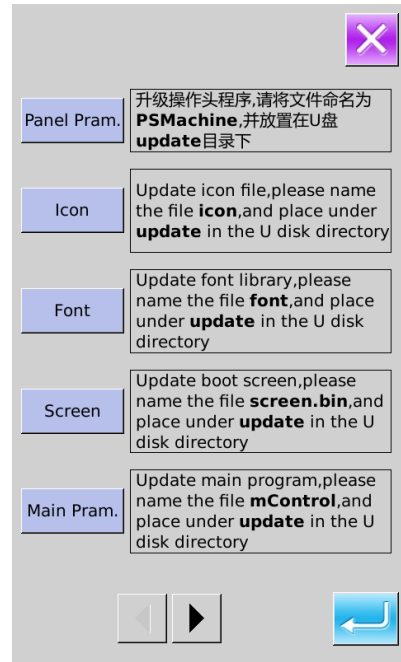

# 9 Information

There are three functions in the information function as below

- 1) Oil replacement time, needle replacement time, cleaning time and so on, are designated and the warning notice is performed when the designated time has passed;
- 2) Speed can be checked at a glance, and the target achieving consciousness of group is increased as well, by using the function to display the target value and the actual value.
- 3) Display the threading

## 9.1 Check the Maintenance Information

### ① Display the information interface

In the data input interface, press the information key (A) the interface of information will be displayed.

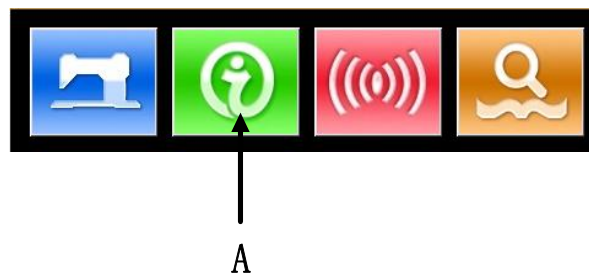

### ② Display the maintenance interface.

Please press button  ( B ) .

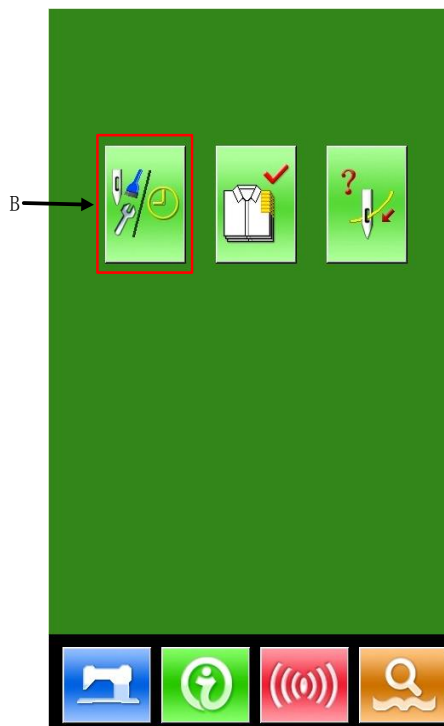



Information on the following three items is displayed in the maintenance information interface.



: Needle replacement (1,000 stitches)



: Cleaning time (hour)



: Oil replacement time (hour)

Each item is displayed as C. The time interval is displayed at D, while remaining time is displayed at E

The remaining time can be cleared, by pressing the corresponding button.

Press  to quit to information interface

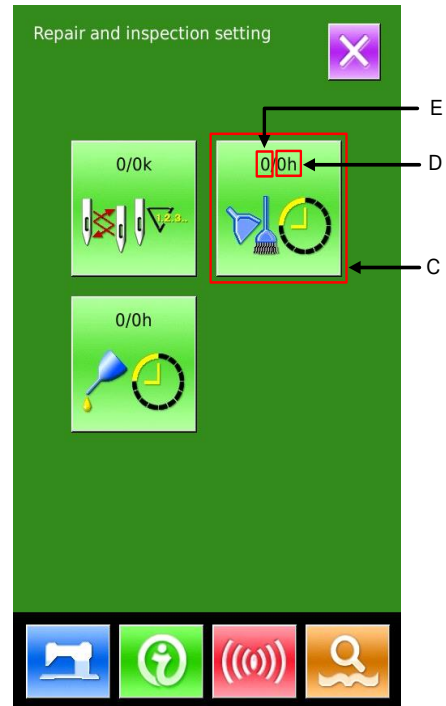

## 9. 2 Set the Maintenance Time

### ⑤ Display the information interface (maintenance personnel level)

In the data input interface, hold the information key (A) for 3 second, the interface of information (maintenance level) will be displaced. In the interface, 6 keys are displayed.

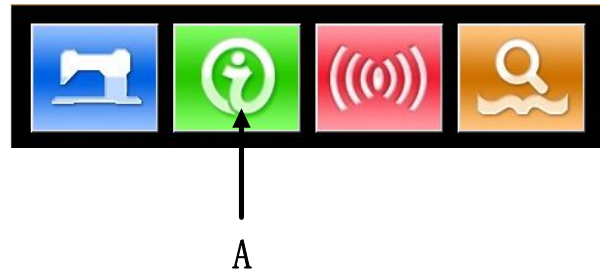

⑥ **Functions Displayed**

At maintenance level, 6 functions are displayed

 : Maintenance

 : Production Control

 : Threading

 : Warning Record

 : Running Record

 : Periodical Password

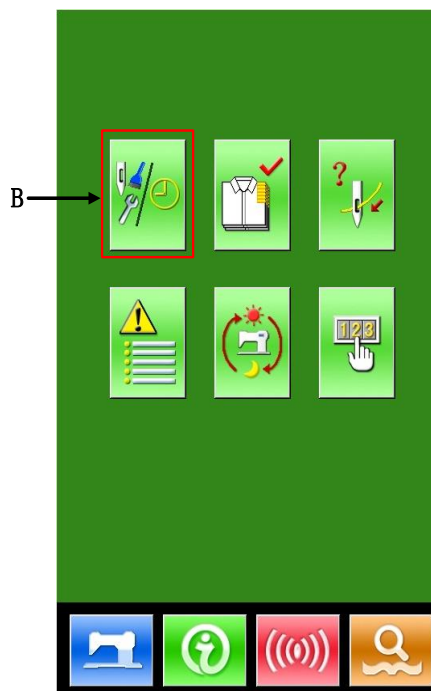

Please press the Maintenance Button  ( B ) to enter the maintenance interface.

⑦ **Maintenance Setting**

In the maintenance information interface, the same information as that in the normal maintenance interface is displayed. Press button (C) to activate the relating input interface.

Press  to set the time for cleaning.

Press  to quit to information interface

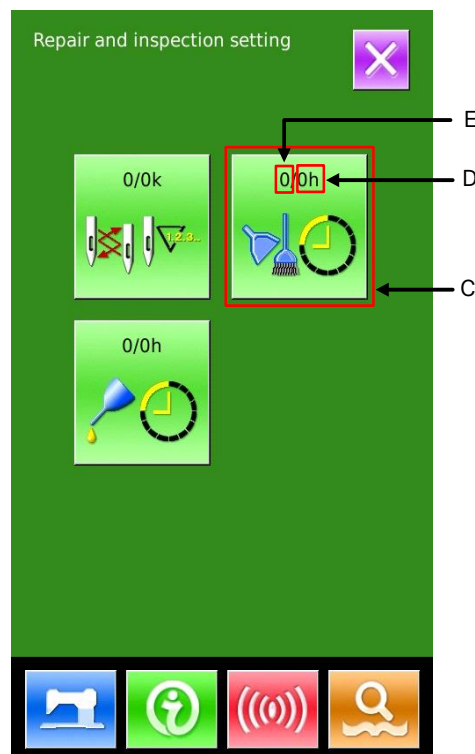

### ⑧ Set item for maintenance

Set the set value of the maintenance item at 0, the system will stop the function of maintenance.

The items of maintenance include:

- ◆ Needle Replacement Time
- ◆ Cleaning Time
- ◆ Oil Replacement Time

Press the figure to enter the relating interface:

A、 Use number keys to input the set value of these items.

B、 Press  to confirm the input.

C、 Press  to quit to maintenance interface.

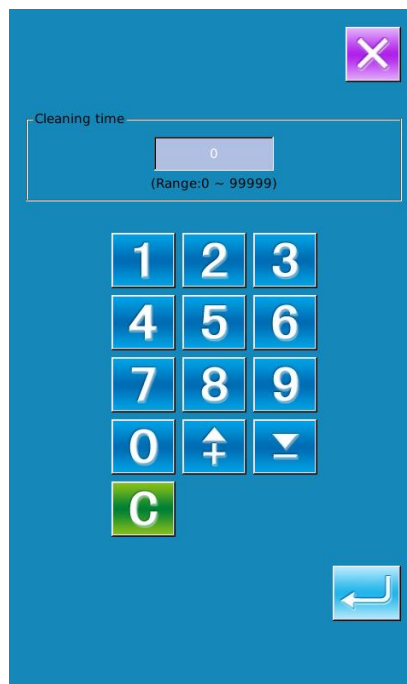

## 9.3 Method to Release the Warning

When the designated inspection time is reached, the warning interface is coming out. Press  to release the warning. Before releasing the maintenance and repair time, the information warning interface will come out upon the complete of each stitch.

The following are the warning code for each item:

- Needle Replacement : M031
- Oil Replacement Time: M032
- Cleaning Time : M033

## 9.4 Information of Production Control

In the production control interface, the system can display the number of production from the start to present and the target number of production, as long as, receiving the start order. There are two ways to enter the interface of production control as below::

- Via Information Interface
- Via Sewing Interface

### 9.4.1 Via Information Interface

① **Display of information interface**

Press the Information Key (A) locating at the switch part in the data input interface, then the system will display the information interface.

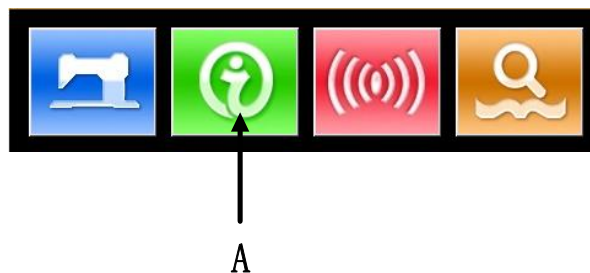

② **Display of production control interface**

Press the production control interface display key (B) in the information interface to enter the interface of production control (as shown in right figure).

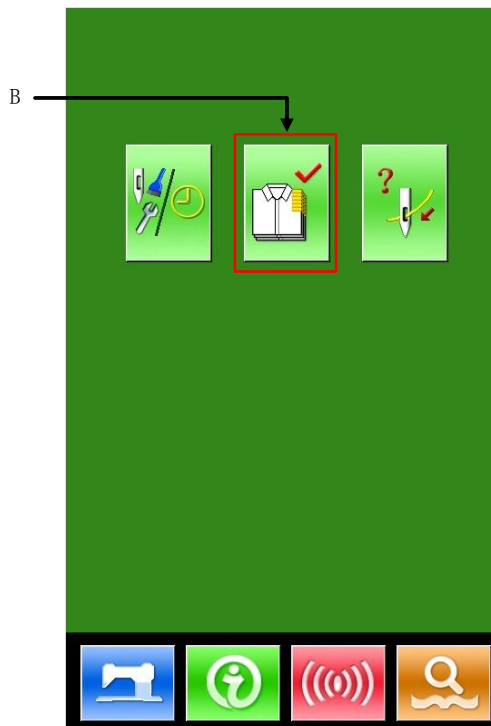

There are five items displayed on the interface of production control as below:

**A : Existing Target Value**

The number of current target pieces is automatically displayed according to the pitch time.

**B : Actual Result Value**

The number of the finished pieces is displayed automatically.

**C : Final Target Value**

Set the final target number of products

**D : Pitch Time of Target**

Time (second) needed for setting one progress.

**E : Unit Interval of Actual**

Time actually needed for completing a process.

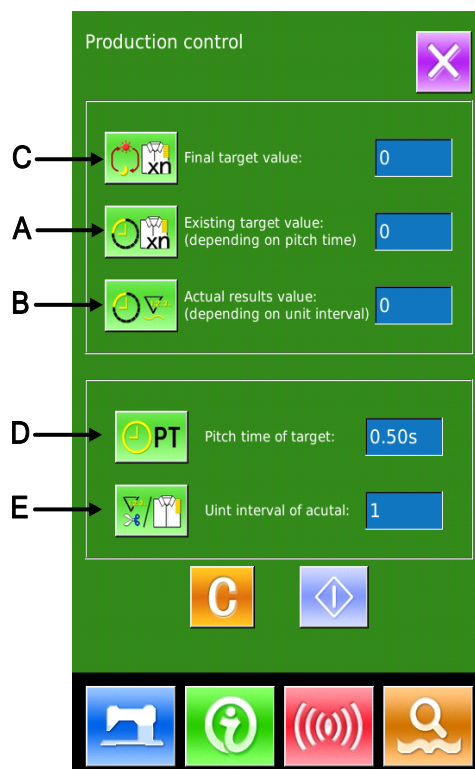

### 9. 4. 2 Via Sewing Interface

① Display the sewing interface

Press the Ready Key  in the data input interface to show the sewing interface.

② Display the production control interface

Press Information Key (A) in the sewing interface to enter the interface of production control.

The contents displayed and functions are the same to the description in 9.4.1.

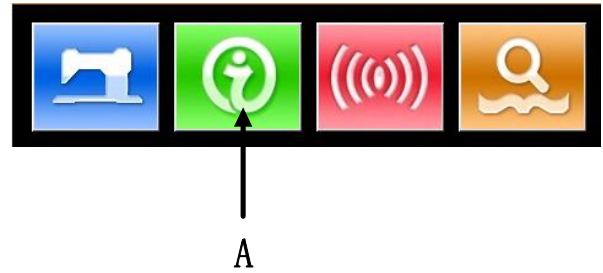

### 9. 4. 3 Setting of Production Control Information

① Display the production control interface

Press  to display the production control interface

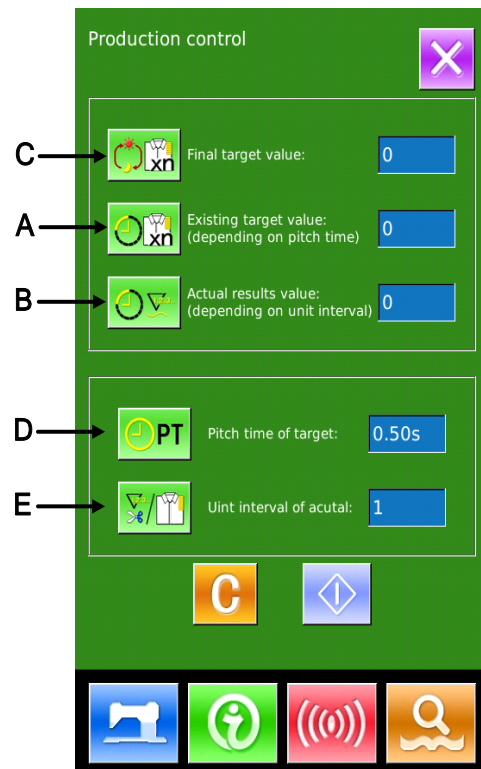



### ② Input the Final Target Value

At first, please input the number of production target pieces in the process to which sewing is performed from now on. Press the Final Target

Value Key  (C) to enter the interface of final target value.

Press the number keys or the “+” button and “-” button to input the figure you want, and then

press  for confirmation. Press  to quit

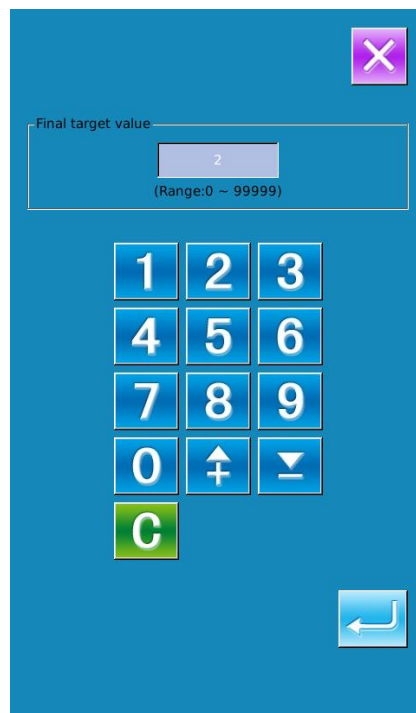



### ③ Input Pitch Time

Then please input the pitch time needed in one

process. Press the Pitch Time Key  (D) in the former page to enter the interface for inputting the pitch time.

Press the number keys or the “+” button and “-” button to input the figure you want, and then

press  for confirmation. Press  to quit

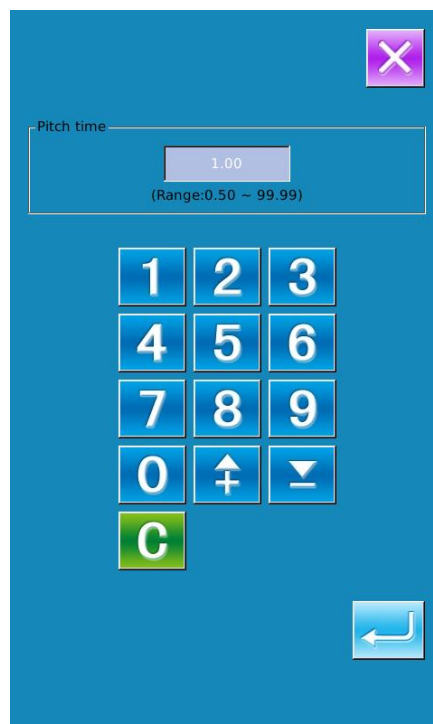

④ **Input the Unit Interval of Actual**

Then we need input the average number of thread trimming in one process. Press the Unit Interval of



Actual (E) in former page to enter the interface for inputting number of thread trimming.

Press the number keys or the “+” button and “-“ button to input the figure you want, and then

press for confirmation. Press to quit

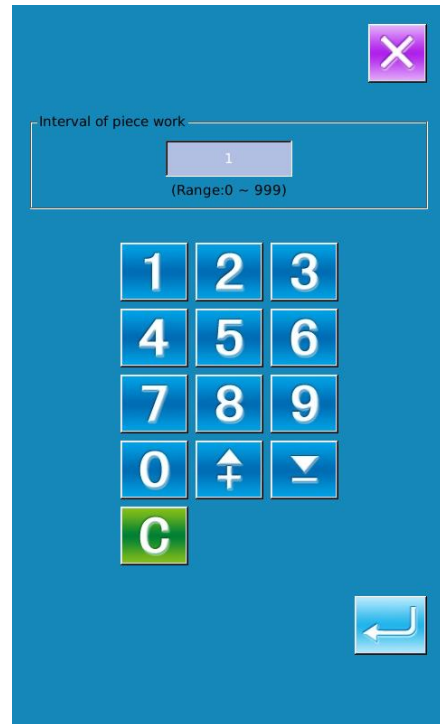

⑤ **Start to count number of production pieces**

Press (I); then the **【Final Target Value】**, **【Existing Target Value】** and **【Actual Result Value】** will go dark and the system will start counting the number of the production pieces.

**Final Target Value:** can be used as the reference of time

**Existing Target Value:** According to the set value at Pitch Time of Target, the machine begin timing and add one to this value after a set time pitch

**Actual Result Value:** When entering via “9.4.2 Via Sewing Interface”, the Actual Result Value will start counting according to the value set at **【Unit Interval of Actual】** and add one to this value at each finish of a piece



**By setting the Existing Target Value and the Actual Result Value, user can find out whether the productivity of one piece is increased or decreased.**

⑥ **Stop counting**

Under the counting status, the Stop Key is

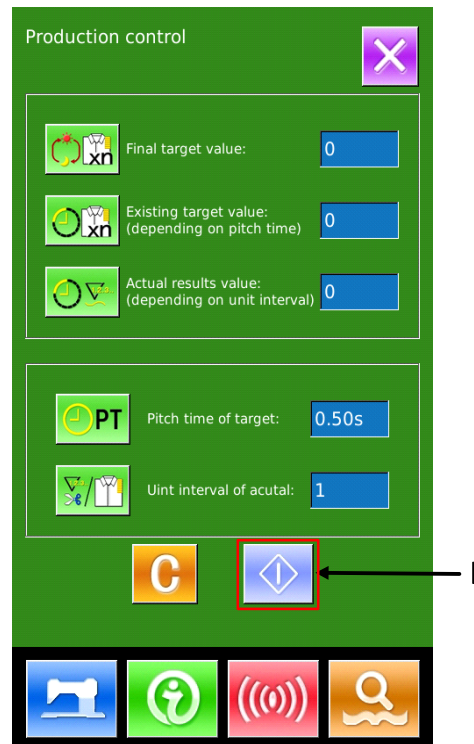
displayed. Press the Stop Key to stop counting.





After the counter stops, the Counting Key  is displayed at the position of the Stop Key. If needing to continue counting, please press the Counting Key . The counted value will not be cleared until the Clear Key  is pressed.

Press  to quit directly



### ⑦ Clear the counted value

When clearing the counted value, make sure the counter is stopped, and then press Clear Key .

The present target value  and the actual value  can be cleared.

(Note: The Clear Key can only be displayed at the counter stopping.)

Press the Clear Key  to enter the interface for confirming the clearing.

In the interface of clearing confirmation, press the  to confirm the clearing. Press  to quit,

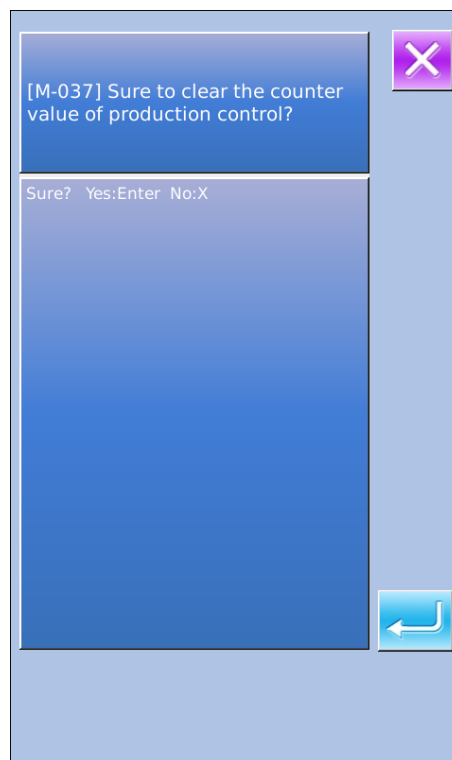





### 9. 5 Threading Figure

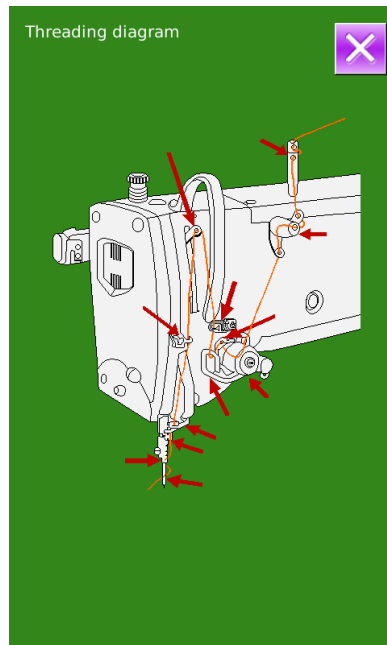
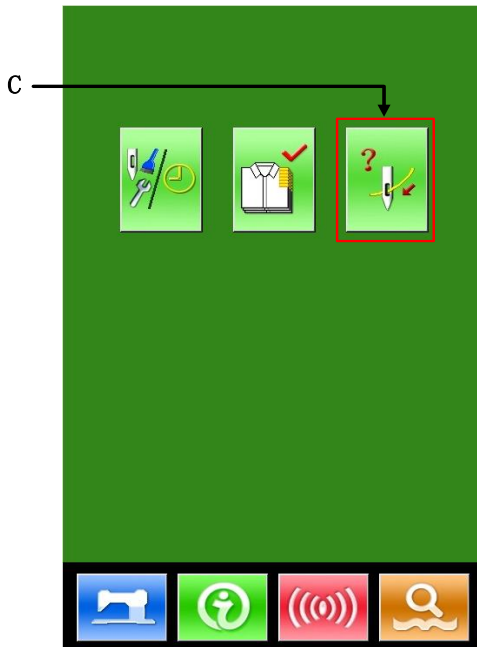

In information interface, press (C) to display the threading figure for your reference.



## 9.6 Warning Record





- ④ In the interface of maintenance level, press the  to inquire the warning records.



- ⑤ Press  to check the records

As in the picture, the warning information and the times of occurrence are displayed

Function of Keys:

- A、 Press  or  to turn pages
- B、 Press  to quit the inquiry
- C、 Press  to clear the saved record

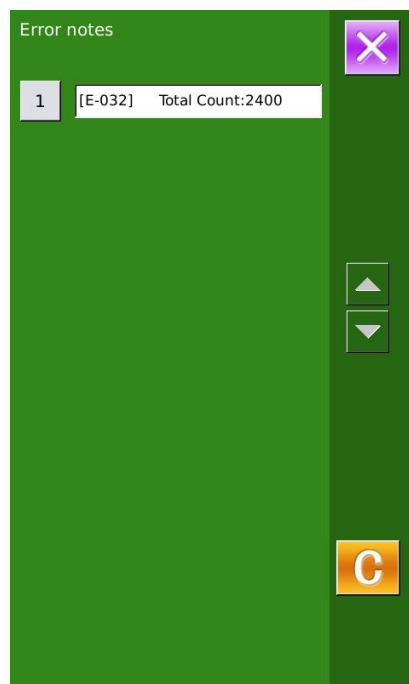

③ Press the number key at the left of the column to display the details of the warning records

Press “ 1 ” to hint the information at right

A、 Press  to quit

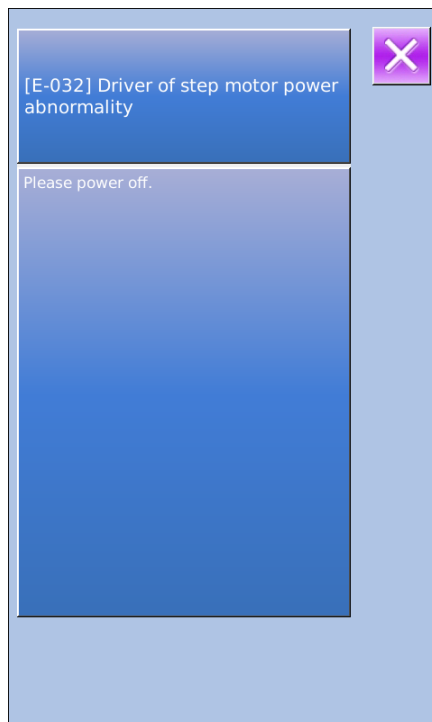

## 9.7 Running Record

③ In the interface of maintenance level, press  to check the running information of the machine.



④ The Running records contain:



: Accumulated running time (Hour)



: Accumulated times for thread trimming



: Accumulated time of power-on (Hour)



: Accumulated number of stitch (1000stitch)

A. Press  to quit

B. Press  to clear the record

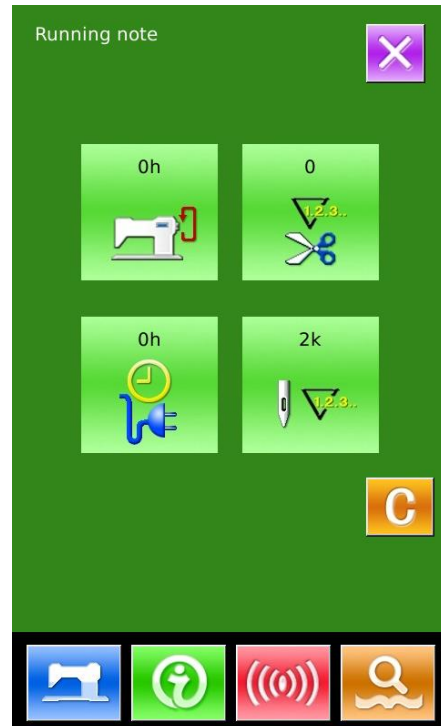

## 9.8 Setting of Periodical Password

⑫ In maintenance level, Press  to set periodical password

In this interface, the system will ask user to input the User ID. Input the right manufacturer ID to enter the password management mode, where user can set and manage the periodical passwords.

- ◆ At most ten periodical passwords with different activation dates can be set
- ◆ The system will display the information of passwords set by manufacturer.



⑬ Press  To input User ID

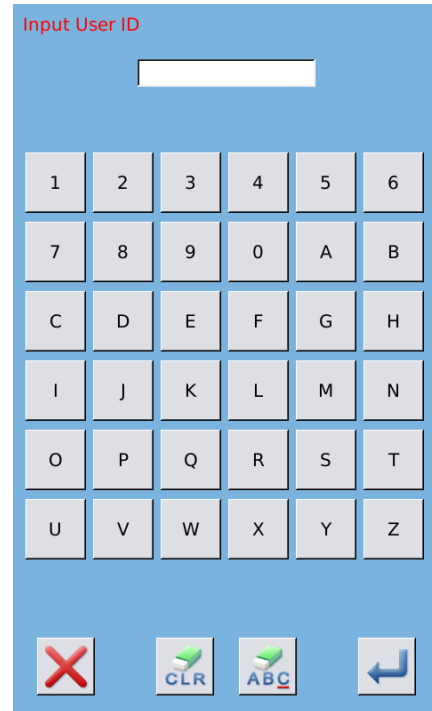

⑭ **Input the Correct Factory ID to enter the password setting interface**

Procedure for setting the periodical password:

- A、 Continue inputting other periodical passwords

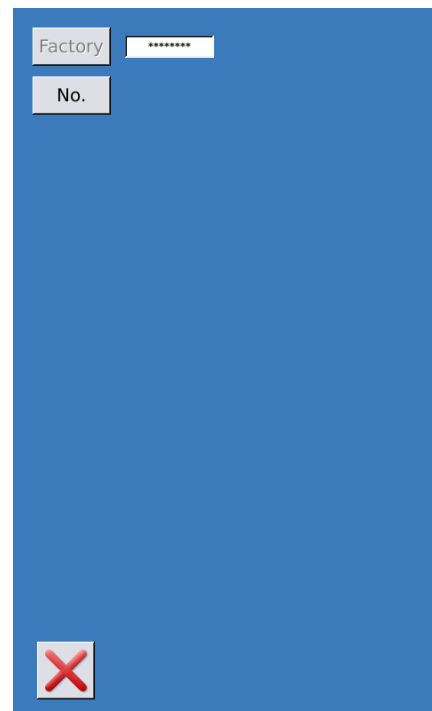

**15 Input Board Number**

Press **【Board Number】** to enter the board number input interface. Input the board number and press



to finish the input

※ The board is a four-figure number, from 0~9999

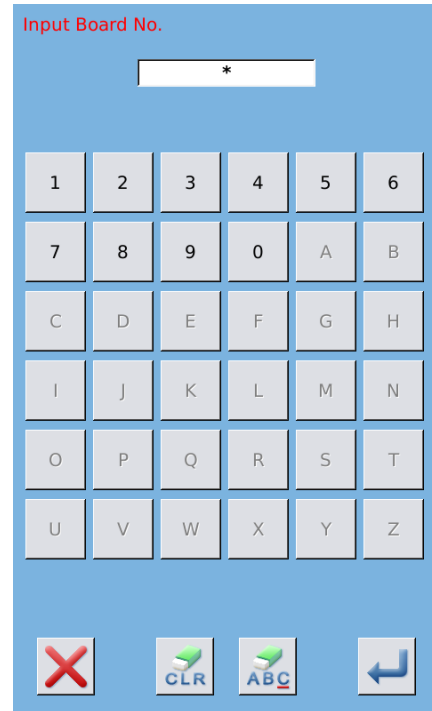

**16 Input System Clock**

Press **【Clock】** to enter the interface for setting the system clock. And set the time



**17 Input the super password**

Press the **【Super Password】** to enter the interface for setting super password

- ※ **At most, nine super passwords can be input**
- ※ **At the password confirmation, make sure the two input passwords are same**

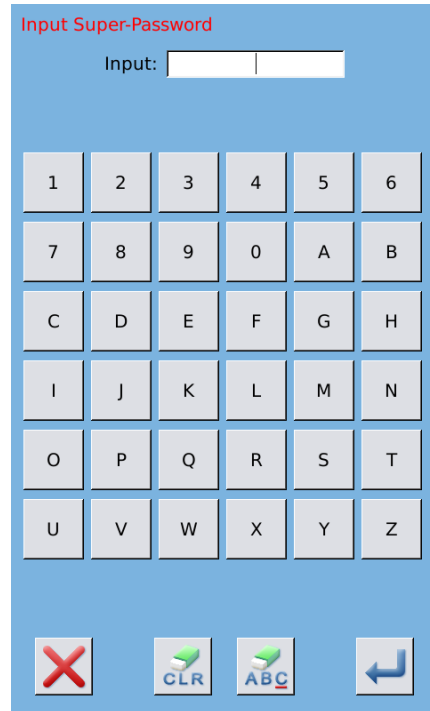

**18 Input periodical password**

Press **【Password-1】** to enter the first password date, where user can input the first date for activation. After selecting the proper date, user can press  for confirmation. Then enter the password setting interface to input the password.

- ※ **The date should not be earlier than the system date**
- ※ **At the password confirmation, make sure the two input passwords are same**

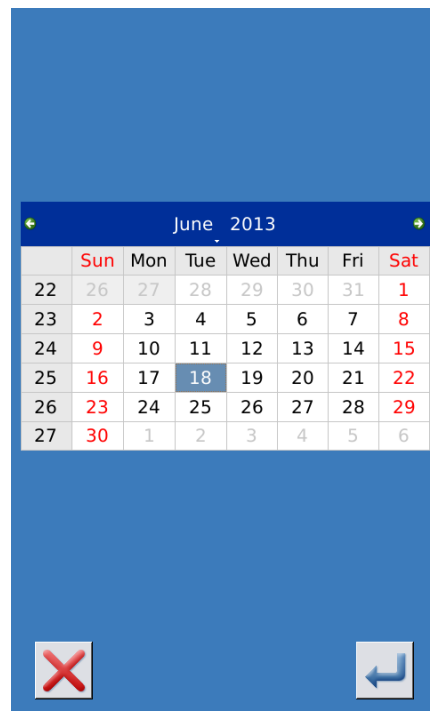

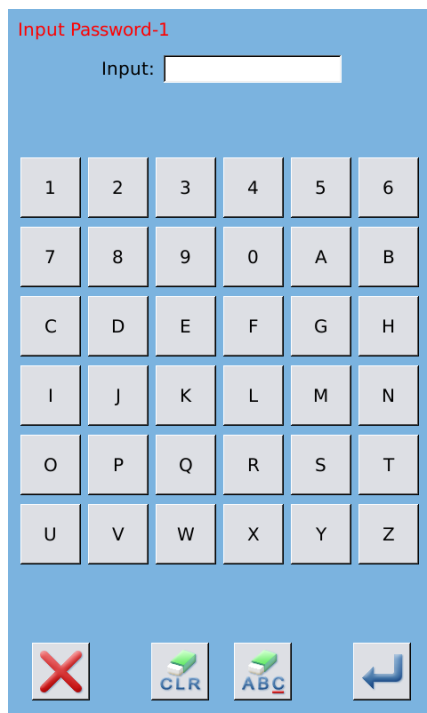

⑲ **Input other periodical password**

The setting of other periodical password is same to that in step ⑦. Please take the reference to that

※ **The next activation date shall be later than the previous date.**

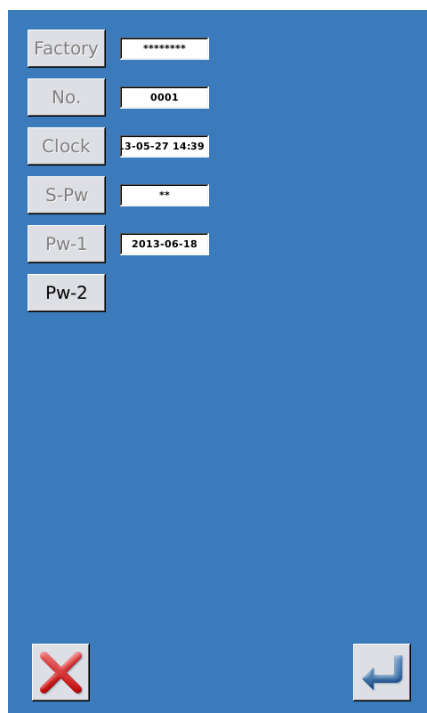



**20 Save Password**

A、 After inputting the password, please press



B、 After the password is saved, the system will display **【Save the password successfully】** .

Press to finish the operation and return to the **【main interface of information】** .

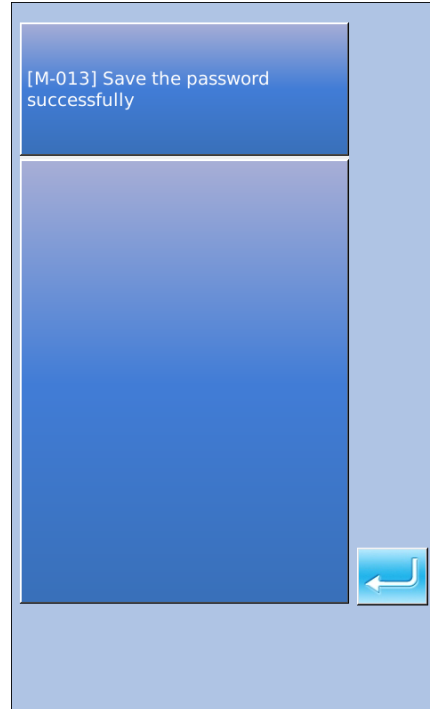

**21 Clear Password before Activation**

It is to clear the passwords before its activation.

A、 The method for entering the password interface is same to that of the password setting

B、 Input the right factory ID to activate the right interface.

C、 The system will display current clock and the activation dates

D、 Press to delete the password orderly

Input the right periodical password to clear the current password. If the super password is input, all passwords will be cleared;

After the deletion of the password, the date of that password will be displayed in **red**.

If all the passwords are cleared, the system will automatically quit to the main interface of information.

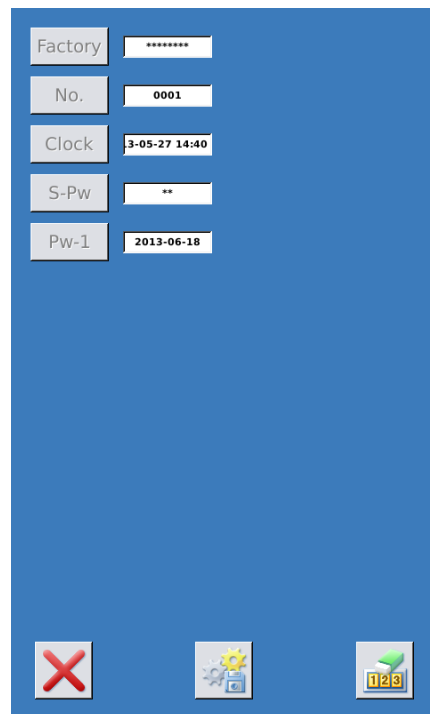

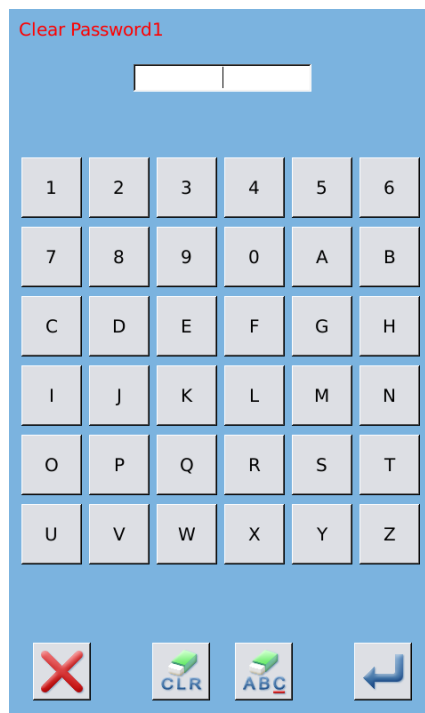

## 22 Clear Password at Activation

If the system has password and that password is still effective, it will be activated at the activation day.

If user wants to use the machine he should input the right password.



A、The effective passwords include current password and super password

B、If the current password is input, the current password will be deleted. After user clears the current password, if it is the last password in machine, no more activation of password will happen in future.

C、If the super password is input, all the periodical passwords will be deleted.

# 10 Appendix 1

## 10. 1 Warning List

No.	Name of Problem	How to recover
E-001	Pedal not at intermediate Position	Self-recovery
E-002	Emergency stop	Press “Reset”
E-004	Main voltage (300V) too low	Turn off Machine
E-005	Main voltage (300V) too high	Self-recovery
E-007	IPM over-voltage or over-current	Turn off Machine
E-008	Supplementary device (24V) over-voltage	Turn off Machine
E-009	Supplementary device (24V) low-voltage	Turn off Machine
E-013	Encoder error or unconnected	Turn off Machine
E-014	Motor running error	Turn off Machine
E-015	Over sewing range	Turn off Machine
E-016	Needle-rod upper position error	Press 
E-017	Thread break detector error	Press 
E-018	Knife position error	Turn off Machine
E-019	Emergency stop switch not at proper position	Self-recovery
E-020	Confirmation of tilt of machine head	Turn off Machine
E-024	Panel is connected to the machine other than supposed	Turn off Machine
E-025	X origin detect error	Turn off Machine
E-026	Y origin detect error	Turn off Machine
E-027	Presser origin detect error	Turn off Machine
E-028	Needle thread trimming origin detect error	Turn off Machine
E-029	Bobbin thread trimming origin detect error	Turn off Machine
E-030	Step driver communication error	Turn off Machine
E-031	Step motor over-current	Turn off Machine
E-032	Step driver power supply error	Turn off Machine
E-033	Needle-rocking over range	Turn off Machine
E-035	Needle thread trimming motor error	Turn off Machine
E-036	Bobbin thread trimming motor error	Turn off Machine
E-037	Knife can't return	Press 
E-038	Knife sensor error	Turn off Machine
E-041	Stepping driver version error	Turn off Machine
E-042	Pattern communication error	Press 

No.	Name of Problem	How to recover
E-043	Parameter transfer error	Press 
E-044	Head board EEROM I/O error	Press 
E-050	System Error	Turn off Machine
E-051	System Error	Turn off Machine
E-060	Stepping Over-current 1	Turn off Machine
E-061	Stepping Over-current 2	Turn off Machine
E-062	Stepping Over-speed 1	Turn off Machine
E-063	Stepping Over-speed 2	Turn off Machine
E-064	Stepping Over-difference 1	Turn off Machine
E-065	Stepping Over-difference 2	Turn off Machine
E-066	Order Covered 1	Turn off Machine
E-067	Order Covered2	Turn off Machine
E-068	MD1 Loading Error	Turn off Machine
E-069	MD1 Communication Error	Turn off Machine
E-090	Stepping Over-current 3	Turn off Machine
E-091	Stepping Over-current 4	Turn off Machine
E-092	Stepping Over-speed 3	Turn off Machine
E-093	Stepping Over-speed 4	Turn off Machine
E-094	Stepping Over-difference 3	Turn off Machine
E-095	Stepping Over-difference 4	Turn off Machine
E-096	Order Covered3	Turn off Machine
E-097	Order Covered4	Turn off Machine
E-098	MD2 Loading Error	Turn off Machine
E-099	MD2 Communication Error	Turn off Machine
E-100	Main-shaft Origin Error	Turn off Machine
E-101	Cooling Fan Abnormal	Turn off Machine
E-102	Presser Cylinder 1 Position Abnormal	Turn off Machine
E-103	Presser Cylinder 2 Position Abnormal	Turn off Machine
E-254	Undefined error	Press 

## 10. 2 Hint List

No.	Name	Content
M-001	Set value too large	Please input value within range
M-002	Set value too small	Please input value within range
M-003	Parameter save error	Press Enter to recover default setting
M-004	Communication error	Communication error between operation panel and control box
M-005	Operation head not match to control box	Please check the model and the software version

M-006	Clock error	The hardware clock is down, please contact manufacturer for repair
M-007	Wrong password	Input again
M-008	Wrong user ID	Input again
M-009	Fail to confirm password	Input password again
M-010	Can not change system time	Periodical password has been set, can not change system time
M-011	Password file input error	
M-012	Password file load error	
M-013	Password save successful	
M-014	Clear all password failed	Can not delete password file
M-015	Fail to clear password	After clearance of password, the input of file has problem
M-016	Password file is deleted without authorization	Password file is deleted without authorization, please turn off machine
M-017	Can not input blank	Input password again
M-018	Current password not match	Input current password again
M-019	New password not match	Input new password again
M-020	Periodical password is same to super password error	Input password again
M-021	Enter touching panel correction mode	Are You Sure? Yes: enter No: X
M-022	Correction successful	Correction is successful, please restart machine
M-023	Correction failed	Please perform correction again
M-024	SRAM initialization	Clear all the data within SRAM, please turn off machine and restore the DIP switch
M-025	Turning off	
M-026	No warning record	
M-027	Clear warning record	Are You Sure? Yes: enter No: X
M-028	USB is pulled out	USB is pulled out
M-029	Can not find pattern in U disk	
M-030	Save software version successful	Software version is saved to the root directory of U disk
M-031	Replace needle	Needle replacement set value is reached, please replace needle
M-032	Replace oil	Oil replacement set value is reached, please replace oil
M-033	Clean machine	Cleaning machine set value is reached, please clean machine
M-034	Clear needle replacement set value	Are You Sure? Yes: enter No: X
M-035	Clear oil replacement set value	Are You Sure? Yes: enter No: X
M-036	Clear cleaning time value	Are You Sure? Yes: enter No: X
M-037	Clear production control value	Are You Sure? Yes: enter No: X
M-038	Over sewing range	Please make sure the pattern is within the sewing range

M-039	Stitch number over range	Please reduce patter stitch number
M-040	Load default patterns	No pattern in memory, please load default patterns
M-041	Patter data not exist	Reload or input from pattern-design software
M-042	Pattern data error	Current pattern data error, it will be replaced by default patterns
M-043	Pattern information file open failed	Restore to default pattern configuration
M-044	Pattern is existed	Can not repeat the pattern
M-045	Memory full	Please delete the unused patterns
M-046	Cover the pattern	Are You Sure? Yes: enter No: X
M-047	Continuous sewing pattern open error	Pattern file has mistake, it will be deleted
M-048	Cyclic sewing pattern open error	Pattern file has mistake, it will be deleted
M-049	Delete pattern data	Press Enter to delete; Press ESC to quit
M-050	Delete the selected pattern	Are You Sure? Yes: enter No: X
M-051	Pattern is used, can not delete	Please release the quotation at other pattern type
M-052	Save at least one pattern	Can not delete last pattern
M-053	Number not exist	Input again
M-054	Sewing counter reaches set value	Please pres Enter to cleat it
M-055	No.of pcs counter reaches set value	Please pres Enter to cleat it
M-056	Pattern-designing calculation error	
M-057	Knife size error	
M-058	Sewing code created at pattern-designing error	
M-059	Over max stitch interval	
M-060	Pattern file type error	
M-061	Delete the selected sub-pattern	Are You Sure? Yes: enter No: X
M-062	Delete all sub-patterns	Are You Sure? Yes: enter No: X
M-063	Restore to default setting	Press Enter to perform operation; Press ESC to quit
M-064	EEPROM knife parameter error	Press Enter to recover default setting
M-065	Restore all the settings	Are You Sure? Yes: enter No: X
M-066	Restore the selected items	Are You Sure? Yes: enter No: X
M-067	Not select an item	Please select one or several parameters
M-068	Clear running records	Are You Sure? Yes: enter No: X
M-069	Successful	Current operation is successful
M-070	Failed	Current operation is failed
M-071	Current cyclic sewing pattern is empty or the quoted continuous sewing pattern is empty	Edit again
M-072	Initialize U disk	Press Enter to perform operation; Press ESC to quit. The initialization will delete all the files in U disk
M-073	Initialize memory	Press Enter to perform operation; Press ESC to quit. The initialization will delete all the files in memory
M-074	Please turn off machine	Current operation is finished, please restart machine
M-075	Parameter restoration successful	Parameter restoration successful, please restart machine
M-076	Fail to open file	Fail to open file

M-077	Not select update item	Please select at least one item for update
M-078	Selected item for update is not existed	If the item has no update file, the system will cancel the selection. If user wants to update the rest, please confirm again
M-079	Update successful	Update successful, please restart machine
M-080	Copy failed, please check memory room	Check the room of memory
M-081	Copy failed, please check U Disk	Check whether the U disk is pulled out
M-082	File I/O error	File I/O error
M-083	Verification failed at updating main software	
M-084	Can not delete pattern data	The selected sewing data is in use
M-085	Perform parameter transfer	Are You Sure? Yes: enter No: X
M-086	Can not open changed pattern	Please confirm pattern file
M-087	Changed pattern format error	Please confirm pattern file
M-088	Changed pattern data is too long	Please confirm pattern file
M-089	Pattern-designing data error	EPD parameter is abnormal
M-090	Can not change counter	At changing, please turn off the setting
M-091	Verification failed at updating main software	

### 10.3 Common Problems and Solutions

No.	Name	Solutions and Steps
E-004	Main voltage too low	3、 Check the input voltage. Make sure it is stable
E-005	Main voltage too high	4、 Check the working condition of main motor
E-007	IPM over-voltage or over-current	
E-008	Supplementary device (24V) over-voltage	3、 Check the connection of cable L451 (X16 Port Cable on control box);
E-009	Supplementary device (24V) low-voltage	4、 Check needle-thread-trimming motor and bobbin thread-trimming motor
E-013	Encoder error or unconnected	4、 Check the connection of Main motor cables (X4 & X5 Port Cable on control box)
E-014	Motor running error	5、 Make sure the mechanical part is not blocked 6、 Check the condition of main motor
E-018	Knife position error	6、 Check mechanical installation. Make sure the knife can return to the origin and the light shield can cover the sensor
E-037	Knife can't return	
E-038	Knife sensor error	7、 Check the connection of L438 Cable 8、 Check the connection of cable L453 (X9 Port Cable on control box) 9、 Enter Test Mode and check the working condition of knife sensor. It should display "OFF" at being covered, and "ON" at being exposed

		10、 Check the condition of knife solenoid and the connecting cable. Use parameter K05 to change the working current of knife solenoid. User can check the working condition of it in test mode
E-025	X origin detect error	6、 Check installing position of mechanical devices, especially the sensor. Generally speaking, the distance between the sensor and the shielding sheet should be kept at 3mm; 7、 Check the cable of the needle-rocking sensor, as well as its connection 8、 Check the connection of cable L453 (X9 Port Cable on control box); 9、 Check the needle-rocking motor and its cable connection (X15 Port Cable of Control Box); 10、 Enter the Test Mode and check the needle-rocking origin sensor. When the needle is at left, the system should display “OFF”, while the “ON” at right. Push the needle from right to left or from left to right, and check the change of display. If the display changes more than once, please adjust the installation position.
E-026	Y origin detect error	6、 Check installing position of mechanical devices, especially the sensor. Generally speaking, the distance between the sensor and the shielding sheet should be kept at 3mm; 7、 Check the cable of the feeding origin sensor, as well as its connection 8、 Check the connection of cable L453 (X9 Port Cable on control box); 9、 Check the feeding motor and its cable (X13 Port Cable on control box) , as well as its connection 10、 Enter the Input Test Mode and check the feeding origin sensor. When the sensor is covered, the system should display “ON”, while the “OFF” at being exposed.
E-027	Presser origin detect error	6、 Check installing position of mechanical devices, especially the sensor. Generally speaking, the distance between the sensor and the shielding sheet should be kept at 3mm; 7、 Check the cable of the presser origin sensor, as well as its connection; 8、 Check the connection of cable L453 (X9 Port Cable on control box); 9、 Check the presser motor and its cable (X12 Port Cable on control box) , as well as its connection.

































		10、 Enter the Input Test Mode and check the presser origin sensor. When the sensor is covered, the system should display “ON”, while the “OFF” at being exposed.
E-028	Needle thread trimming origin detect error	6、 Check installing position of mechanical devices, especially the sensor. Make sure no blockage in the installation. Generally speaking, the distance between the sensor and the shielding sheet should be kept at 3mm; 7、 Check the needle-thread-trimming origin sensor. Enter the Input Test Mode; cover the sensor with an iron sheet. The system should display ON at this moment; 8、 Check the connection of cable L453 (X9 Port Cable on control box); 9、 Check the connection of cable L451; 10、 Check the motor and its connecting cables. If the motor has problem, please replace the motor.
E-035	Needle thread trimming motor error	
E-029	Bobbin thread trimming origin detect error	6、 Check installing position of mechanical devices, especially the sensor. Make sure no blockage in the installation. Generally speaking, the distance between the sensor and the shielding sheet should be kept at 3mm; 7、 Check the bobbin-thread-trimming origin sensor. Enter the Input Test Mode; cover the sensor with an iron sheet. The system should display ON at being covered, while “OFF” at being exposed 8、 Check the connection of cable L453 (X9 Port Cable on control box) 9、 Check the connection of cable L451; 10、 Check the motor and its connecting cables. If the motor has problem, please replace the motor.
E-036	Bobbin thread trimming motor error	
E-030	Step driver communication error	3、 Check the Connection of the Cable C059-1 (inside control box) 4、 Check the software of the stepping driver Note: In sometimes, the system will also give this warning at power-off, it is also normal.
E-031	Step motor over-current	3、 Check needle-rocking motor, feeding motor, presser-lifting motor and knife solenoid. Make sure no blockage at mechanism 4、 Repower the machine. If the problem goes still, please replace the board MD301.
E-032	Step driver power supply error	3、 Check the Connection of the Cable H079-1 (inside control box)

		4、 Check the inlet voltage of X12 port. The normal value is 300V
E-041	Stepping driver version error	Replace the stepping driving software or the MD301 board
E-044	Head board EEROM I/O error	3、 Check the connection of cable L453 (X9 Port Cable on control box). If the cable has problem, please replace that cable 4、 If the cable is ok, please replace SC041 board
M-004	Communication error	Check the connection of cable between operation panel and control box (X7 Port Cable on control box)
M-005	Operation head not match to control box	Replace the proper control box software or the operation head software

## 10. 4 Default Values of Sewing Shapes















The following are the Default Values of sewing shape

No.	Item	Unit															
S01	Sewing Shape	mm															
S02	Length of cloth cutting	mm	12.7	12.7	12.7	12.7	12.7	12.7	12.7	12.7	12.7	12.7	12.7	12.7	12.7	12.7	12.7
S03	Knife groove width, right	mm	0.10	0.10	0.10	0.10	0.10	0.10	0.10	0.10	0.10	0.10	0.10	0.10	0.10	0.10	0.10
S04	Knife groove width, left	mm	0.10	0.10	0.10	0.10	0.10	0.10	0.10	0.10	0.10	0.10	0.10	0.10	0.10	0.10	0.10
S05	Over-edging width, left	mm	1.70	1.70	1.70	1.70	1.70	1.70	1.40	1.40	1.40	1.40	1.70	1.70	1.70	1.70	1.70
S06	Ratio of right and left shapes	%	100	100	100	100	100	100	100	100	100	100	100	100	100	100	100
S07	Pitch at parallel section	mm	0.35	0.35	0.35	0.35	0.35	0.35	0.35	0.35	0.35	0.35	0.35	0.35	0.35	0.35	0.35
S08	2nd bar-tacking length	mm	1.0	—	1.0	—	1.5	3.0	1.0	—	1.5	3.0	—	1.0	1.0	1.5	3.0
S09	1st bar-tacking length	mm	1.0	—	—	—	—	—	—	—	—	—	—	—	—	—	—
S10	Compensation of bar-tacking width, right	mm	0	—	0	—	0	—	0	—	0	—	—	0	0	0	—
S11	Compensation of bar-tacking width, left	mm	0	—	0	—	0	—	0	—	0	—	—	0	0	0	—
S12	Left Taper Bar-tacking	mm	—	—	—	—	—	0.85	—	—	—	0.85	—	—	—	—	0.85
S13	Right Taper Bar-tacking	mm	—	—	—	—	—	0.85	—	—	—	0.85	—	—	—	—	0.85
S14	Eyelet shape length	mm	—	—	—	—	—	—	2.0	2.0	2.0	2.0	—	—	—	—	—
S15	Number of stitches of eyelet shape	Stitch	—	—	—	—	—	—	3	3	3	3	—	—	—	—	—
S16	Eyelet width	mm	—	—	—	—	—	—	1.0	1.0	1.0	1.0	—	—	—	—	—
S17	Eyelet length	mm	—	—	—	—	—	—	3.0	3.0	3.0	3.0	—	—	—	—	—
S18	Round type shape length	mm	—	2.0	2.0	2.0	2.0	2.0	—	2.0	—	—	2.0	2.0	2.0	2.0	2.0
S19	Number of radial shape stitches	Stitch	—	—	3	3	3	3	—	3	—	—	—	—	—	—	—
S20	Radial bar-tacking	—	—	—	No	No	No	No	—	No	—	—	—	—	—	—	—
S21	Pitch at bar-tacking section	mm	0.30	0.30	0.30	-	0.30	0.30	0.30	-	0.30	0.30	0.25	0.30	0.25	0.25	0.25
S22	1 <sup>st</sup> clearance	mm	1.5	1.5	1.5	1.5	1.5	1.5	1.5	1.5	1.5	1.5	1.5	1.5	1.5	1.5	1.5
S23	2nd clearance	mm	1.3	1.3	1.3	1.3	1.3	1.3	1.3	1.3	1.3	1.3	1.3	1.3	1.3	1.3	1.3

S31	Single/ Double Sewing	—	Single	Single	Single	Single	Single	Single	Single	Single	Single	Single	Single	Single	Single	Single	Single
S32	Select Cross at Double Sewing	—	<	<	<	<	<	<	<	<	<	<	<	<	<	<	<
S33	Compensation of Double Sewing Width	mm	0	0	0	0	0	0	0	0	0	0	0	0	0	0	0
S34	Number of Basting Times	Time	0	0	0	0	0	0	0	0	0	0	0	0	0	0	0
S35	Basting Pitch	mm	4.0	4.0	4.0	4.0	4.0	4.0	4.0	4.0	4.0	4.0	4.0	4.0	4.0	4.0	4.0
S36	Rolling Length of Basting	mm	8.0	8.0	8.0	8.0	8.0	8.0	8.0	8.0	8.0	8.0	8.0	8.0	8.0	8.0	8.0
S37	Rolling Pitch of Basting	mm	0.8	0.8	0.8	0.8	0.8	0.8	0.8	0.8	0.8	0.8	0.8	0.8	0.8	0.8	0.8
S38	Rolling Width of Basting	mm	1.5	1.5	1.5	1.5	1.5	1.5	1.5	1.5	1.5	1.5	1.5	1.5	1.5	1.5	1.5
S39	Lengthwise Compensation of Needle Entry at Basting	mm	1.5	1.5	1.5	1.5	1.5	1.5	1.5	1.5	1.5	1.5	1.5	1.5	1.5	1.5	1.5
S40	Horizontal Compensation of Needle Entry at Basting	mm	0	0	0	0	0	0	0	0	0	0	0	0	0	0	0
S41	Compensation of Left Side Position at Basting	mm	0	0	0	0	0	0	0	0	0	0	0	0	0	0	0
S42	Compensation of Right Side Position at Basting	mm	0	0	0	0	0	0	0	0	0	0	0	0	0	0	0
S44	Basting Speed	mm	2000	2000	2000	2000	2000	2000	2000	2000	2000	2000	2000	2000	2000	2000	2000
S45	Pair-sewing	—	No	No	No	No	No	No	No	No	No	No	No	No	No	No	No
S46	Pair-sewing Width	mm	2.0	2.0	2.0	2.0	2.0	2.0	2.0	2.0	2.0	2.0	2.0	2.0	2.0	2.0	2.0
S47	Pair-sewing Pitch	mm	2.0	2.0	2.0	2.0	2.0	2.0	2.0	2.0	2.0	2.0	2.0	2.0	2.0	2.0	2.0
S51	Left Parallel Tension	—	60	60	60	60	60	60	60	60	60	60	60	60	60	60	60
S52	Right Parallel Tension	—	60	60	60	60	60	60	60	60	60	60	60	60	60	60	60
S53	Left Parallel Tension (1 <sup>st</sup> lap at double sewing)	—	60	60	60	60	60	60	60	60	60	60	60	60	60	60	60
S54	Right Parallel Tension (1 <sup>st</sup> lap at	—	60	60	60	60	60	60	60	60	60	60	60	60	60	60	60

	double sewing)																
S55	1 <sup>st</sup> Bar-tacking Tension	—	35	60	120	35	35	35	60	60	60	60	60	60	60	60	60
S56	2 <sup>nd</sup> Bar-tacking Tension	—	35	60	35	35	35	35	60	60	60	60	60	60	60	60	606
S57	Set Needle Thread Tension at Sewing Start	—	25	25	25	25	25	25	25	25	25	25	25	25	25	25	25
S58	Set the Needle Thread Tension at Basting	—	80	80	80	80	80	80	80	80	80	80	80	80	80	80	80
S59	ACT Timing Adjustment at 1st Bar-tacking Start	Stitch	0	0	0	0	0	0	0	0	0	0	0	0	0	0	0
S60	ACT Timing Adjustment at Right Over-edging Start	Stitch	0	0	0	0	0	0	0	0	0	0	0	0	0	0	0
S61	ACT Timing Adjustment at 2nd Bar-tacking Start	Stitch	0	0	0	0	0	0	0	0	0	0	0	0	0	0	0
S62	Bar-tacking Stitch Number at Sewing Start	Stitch	3	3	3	3	3	3	3	3	3	3	3	3	3	3	3
S63	Bar-tacking Pitch at Sewing Start	-	0	0	0	0	0	0	0	0	0	0	0	0	0	0	0
S64	Bar-tacking Width at Sewing Start	mm	0.6	0.6	0.6	0.6	0.6	0.6	0.6	0.6	0.6	0.6	0.6	0.6	0.6	0.6	0.6
S65	Vertical Adjustment of Bar-Tacking Sewing at Sewing Start	mm	0	1.5	0	1.5	0	0	0	1.5	0	0	1.5	0	0	0	0
S66	Horizontal Adjustment of Bar-Tacking Sewing at Sewing Start	mm	0	0	0	0	0	0.7	0	0	0	0.7	0	0	0	0	0.7
S67	Bar-tacking Width at Sewing End	mm	0.6	0.6	0.6	0.6	0.6	0.6	0.6	0.6	0.6	0.6	0.6	0.6	0.6	0.6	0.6
S68	Bar-tacking Stitch Number at Sewing End	Stitch	3	3	3	3	3	3	3	3	3	3	3	3	3	3	3
S69	Vertical Adjustment of Bar-Tacking Sewing at Sewing	mm	0	0	0	0	0	0	0	0	0	0	0	0	0	0	0

	End																
S70	Horizontal Adjustment of Bar-Tacking Sewing at Sewing End	mm	0.9	0.9	0.9	0.9	0	0.7	0.9	0.9	0	0.7	0.9	0.9	0.9	0	0.7
S81	Knife motion	—	Yes	Yes	Yes	Yes	Yes	Yes	Yes	Yes	Yes	Yes	Yes	Yes	Yes	Yes	Yes
S83	Knife motion at 1st lap of double stitching	—	No	No	No	No	No	No	No	No	No	No	No	No	No	No	No
S84	Max Speed Limitation	rpm	3600	3600	3600	3600	3600	3600	3600	3600	3600	3600	3600	3600	3600	3600	3600
S86	Pitch of Forward	mm															
S87	Width of Forward	mm															
S88	Pitch of Return	mm															
S89	Width of Return	mm															

No.	Item	Unit																
S01	Sewing Shape	mm																
S02	Length of cloth cutting	mm	12.7	12.7	12.7	12.7	12.7	12.7	12.7	12.7	12.7	12.7	12.7	12.7	13	19.1	19.1	19.1
S03	Knife groove width, right	mm	0.10	0.10	0.10	0.10	0.10	0.10	0.10	0.10	0.10	0.10	0.10	0.10	—	—	0.10	0.10
S04	Knife groove width, left	mm	0.10	0.10	0.10	0.10	0.10	0.10	0.10	0.10	0.10	0.10	0.10	0.10	—	0.10	—	0.10
S05	Over-edging width, left	mm	1.40	1.40	1.70	1.70	1.70	1.70	1.70	1.70	1.70	1.70	1.70	1.70	—	—	—	—
S06	Ratio of right and left shapes	%	100	100	100	100	100	100	100	100	100	100	100	100	—	—	—	—
S07	Pitch at parallel section	mm	0.35	0.35	0.35	0.35	0.35	0.35	0.35	0.35	0.35	0.35	0.35	0.35	—	—	—	—
S08	2nd bar-tacking length	mm	—	—	—	—	—	1.5	3.0	—	—	—	—	—	—	—	—	—
S09	1st bar-tacking length	mm	—	—	1.0	1.0	1.0	1.0	1.0	—	—	—	—	—	—	—	—	—
S10	Compensation of bar-tacking width, right	mm	—	—	0	0	0	0	0	—	—	—	—	—	—	—	—	—
S11	Compensation of bar-tacking width, left	mm	—	—	0	0	0	0	0	—	—	—	—	—	—	—	—	—
S12	Left Taper Bar-tacking	mm	—	—	—	—	—	—	0.85	—	—	—	—	—	—	—	—	—

S13	Right Taper Bar-tacking	mm	—	—	—	—	—	—	0.85	—	—	—	—	—	—	—	—
S14	Length of Eyelet buttonhole	mm	2.0	2.0	—	—	—	—	—	—	—	—	—	—	—	—	—
S15	Number of stitches of eyelet shape	针	3	3	—	—	—	—	—	—	—	—	—	—	—	—	—
S16	Eyelet width	mm	1.0	1.0	—	—	—	—	—	—	—	—	—	—	—	—	—
S17	Eyelet shape length	mm	3.0	3.0	—	—	—	—	—	—	—	—	—	—	—	—	—
S18	Round type shape length	mm	2.0	2.0	2.0	2.0	2.0	—	—	2.0	2.0	2.0	2.0	—	—	—	—
S19	Number of radial shape stitches	Stitch	—	—	3	—	—	—	—	3	3	3	—	—	—	—	—
S20	Radial bar-tacking	—	—	—	No	—	—	—	—	No	No	NO	—	—	—	—	—
S21	Pitch at bar-tacking section	mm	0.25	0.30	0.30	0.25	0.30	0.30	0.30	0.25	0.30	0.25	0.25	—	—	—	—
S22	1 <sup>st</sup> clearance	mm	1.5	1.5	1.5	1.5	1.5	1.5	1.5	1.5	1.5	1.5	1.5	—	2.0	2.0	2.0
S23	2nd clearance	mm	1.3	1.3	1.3	1.3	1.3	1.3	1.3	1.3	1.3	1.3	1.3	—	2.0	2.0	2.0
S31	Single/ Double Sewing	—	Single	Single	Single	Single	Single	Single	Single	Single	Single	Single	Single	—	—	—	Single
S32	Select Cross at Double Sewing	—	<	<	<	<	<	<	<	<	<	<	<	—	—	—	<
S33	Compensation of Double Sewing Width	mm	0	0	0	0	0	0	0	0	0	0	0	—	—	—	—
S34	Number of Basting Times	Time	0	0	0	0	0	0	0	0	0	0	0	3	2	2	—
S35	Basting Pitch	mm	4.0	4.0	4.0	4.0	4.0	4.0	4.0	4.0	4.0	4.0	4.0	4.0	4.0	4.0	—
S36	Rolling Length of Basting	mm	8.0	8.0	8.0	8.0	8.0	8.0	8.0	8.0	8.0	8.0	8.0	8.0	8.0	8.0	—
S37	Rolling Pitch of Basting	mm	0.8	0.8	0.8	0.8	0.8	0.8	0.8	0.8	0.8	0.8	0.8	0.8	0.8	0.8	—
S38	Rolling Width of Basting	mm	1.5	1.5	1.5	1.5	1.5	1.5	1.5	1.5	1.5	1.5	1.5	1.5	1.5	1.5	—
S39	Lengthwise Compensation of Needle Entry at Basting	mm	1.5	1.5	1.5	1.5	1.5	1.5	1.5	1.5	1.5	1.5	1.5	1.5	1.5	1.5	—
S40	Horizontal Compensation of Needle Entry at Basting	mm	0	0	0	0	0	0	0	0	0	0	0	0	0	0	—
S41	Compensation of Left Side Position at	mm	0	0	0	0	0	0	0	0	0	0	0	0	0	0	—

	Basting																	
S42	Compensation of Right Side Position at Basting	mm	0	0	0	0	0	0	0	0	0	0	0	0	0	0	0	—
S44	Basting Speed	mm	2000	2000	2000	2000	2000	2000	2000	2000	2000	2000	2000	2000	2000	2000	2000	—
S45	Pair-sewing	—	No	No	No	No	No	No	No	No	No	No	—	—	—	—	—	—
S46	Pair-sewing Width	mm	2.0	2.0	2.0	2.0	2.0	2.0	2.0	2.0	2.0	2.0	2.0	—	—	—	—	—
S47	Pair-sewing Pitch	mm	2.0	2.0	2.0	2.0	2.0	2.0	2.0	2.0	2.0	2.0	2.0	—	—	—	—	—
S51	Left Parallel Tension	—	60	60	60	60	60	60	60	60	60	60	60	60	60	60	60	60
S52	Right Parallel Tension	—	60	60	60	60	60	60	60	60	60	60	60	60	60	60	60	60
S53	Left Parallel Tension (1 <sup>st</sup> lap at double sewing)	—	60	60	60	60	60	60	60	60	60	60	60	60	—	—	—	—
S54	Right Parallel Tension (1 <sup>st</sup> lap at double sewing)	—	60	60	60	60	60	60	60	60	60	60	60	60	—	—	—	—
S55	1 <sup>st</sup> Bar-tacking Tension	—	60	60	60	60	60	60	60	60	60	60	60	60	—	—	—	—
S56	2 <sup>nd</sup> Bar-tacking Tension	—	60	60	60	60	60	60	60	60	60	60	60	60	—	—	—	—
S57	Set Needle Thread Tension at Sewing Start	—	25	25	25	25	25	25	25	25	25	25	25	25	25	25	25	25
S58	Set the Needle Thread Tension at Basting	—	80	80	80	80	80	80	80	80	80	80	80	80	80	80	80	80
S59	ACT Timing Adjustment at 1 <sup>st</sup> Bar-tacking Start	Stitch	0	0	0	0	0	0	0	0	0	0	0	0	—	—	—	—
S60	ACT Timing Adjustment at Right Over-edging Start	Stitch	0	0	0	0	0	0	0	0	0	0	0	0	0	0	0	0
S61	ACT Timing Adjustment at 2 <sup>nd</sup> Bar-tacking Start	Stitch	0	0	0	0	0	0	0	0	0	0	0	0	—	—	—	—
S62	Bar-tacking Stitch Number at Sewing Start	Stitch	3	3	3	3	3	3	3	3	3	3	3	3	3	3	3	3
S63	Bar-tacking Pitch at Sewing Start	-	0	0	0	0	0	0	0	0	0	0	0	0	0	0	0	0
S64	Bar-tacking Width	mm	0.6	0.6	0.6	0.6	0.6	0.6	0.6	0.6	0.6	0.6	0.6	0.6	0.6	0.6	0.6	0.6



	at Sewing Start																
S65	Vertical Adjustment of Bar-Tacking Sewing at Sewing Start	mm	1.5	1.5	1.5	1.5	1.5	0	0	1.5	1.5	1.5	1.5	0	0	0	0
S66	Horizontal Adjustment of Bar-Tacking Sewing at Sewing Start	mm	0	0	0	0	0	0	0.7	0	0	0	0	0	0	0	0
S67	Bar-tacking Width at Sewing End	mm	0.6	0.6	0.6	0.6	0.6	0.6	0.6	0.6	0.6	0.6	0.6	0.6	0.6	0.6	0.6
S68	Bar-tacking Stitch Number at Sewing End	Stitch	3	3	3	3	3	3	3	3	3	3	3	3	3	3	3
S69	Vertical Adjustment of Bar-Tacking Sewing at Sewing End	mm	0	0	0	0	0	0	0	0	0	0	0	0	0	0	0
S70	Horizontal Adjustment of Bar-Tacking Sewing at Sewing End	mm	0.9	0.9	0.9	0.9	0.9	0	0.7	0.9	0.9	0.9	0.9	0	0	0	0
S81	Knife motion	—	Yes	Yes	Yes	Yes	Yes	Yes	Yes	Yes	Yes	Yes	Yes	—	Yes	Yes	Yes
S83	Knife motion at 1st lap of double stitching	—	No	No	No	No	No	No	No	No	No	No	No	—	—	—	—
S84	Max Speed Limitation	rpm	3600	3600	3600	3600	3600	3600	3600	3600	3600	3600	3600	3600	3600	3600	3600
S86	Pitch of Forward	mm												0.80	0.80	0.80	0.80
S87	Width of Forward	mm												1.7	1.7	1.7	1.7
S88	Pitch of Return	mm												0.80	0.80	0.80	0.80
S89	Width of Return	mm												1.7	1.7	1.7	1.7

# 11 Appendix 2

## 11.1 Installation Size of Control Box

### 1、SC500 Installation Size of Control Box

At present, there are two installation types for the controller, which are 4-hole installation and 3-hole installation. Please refer to the picture at below for the detailed size:

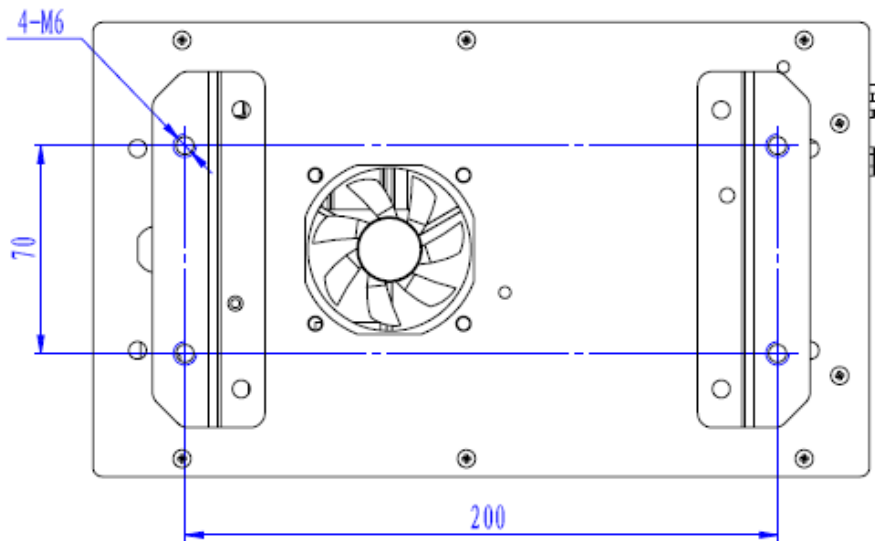

Figure 1 4-hole Installation

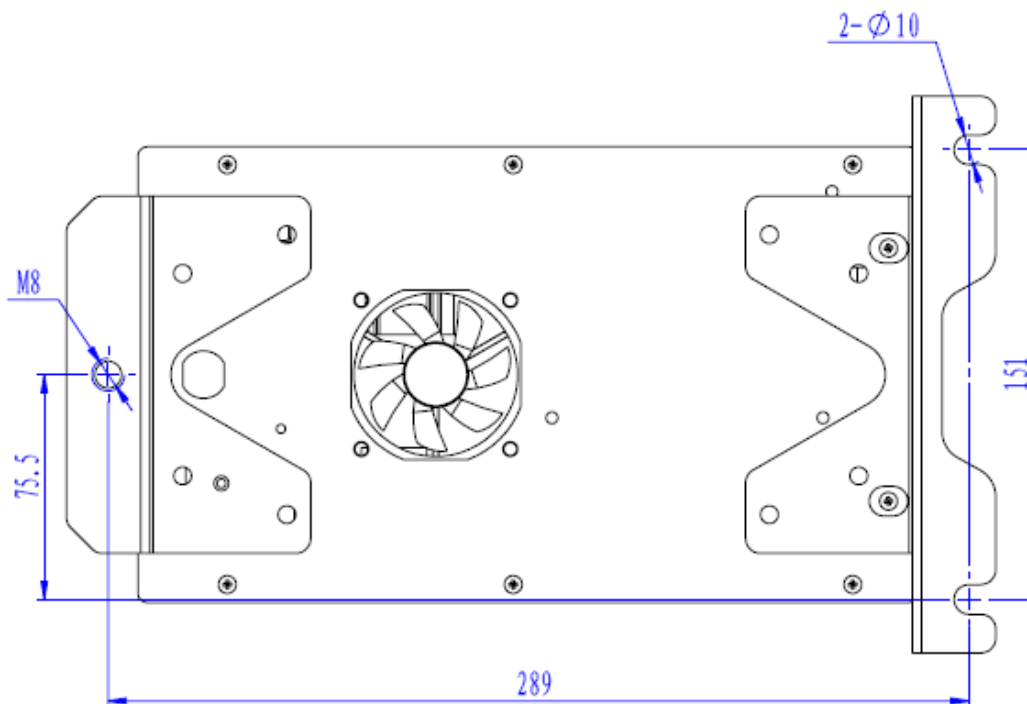
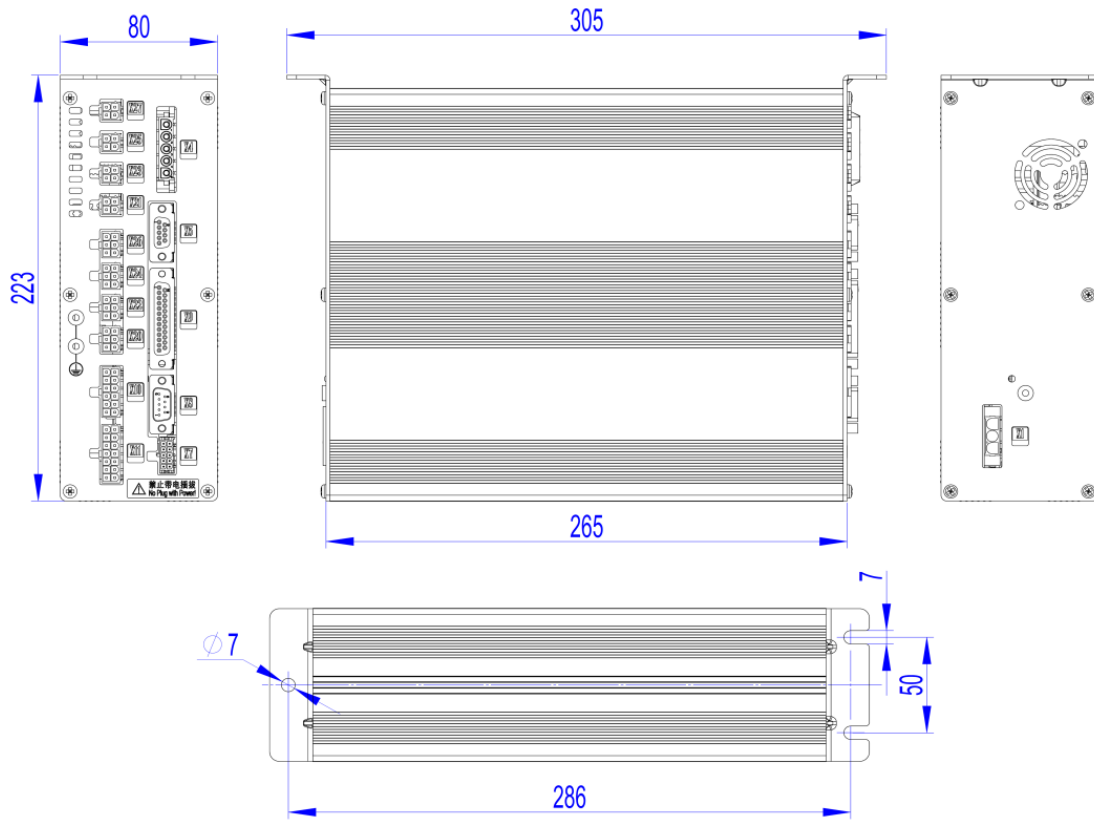
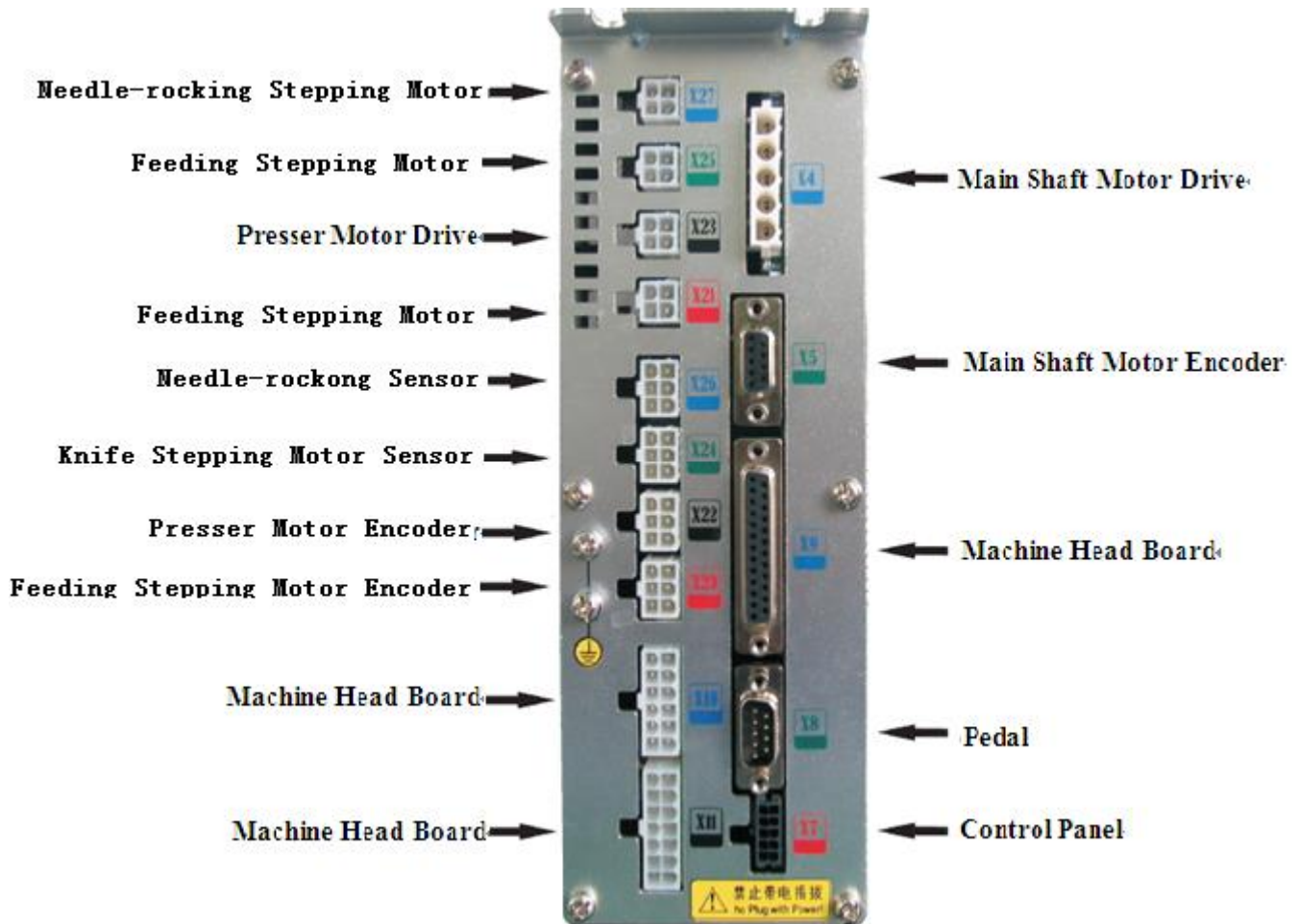

Figure 2 3-hole Installation

2、MASC500 Installation Size of Control Box



## 11.2 External Cable Connection of Control Box



MASC500Control Box Back Wiring Interface Diagram

### 11.3 Installation Size of Operation Panel

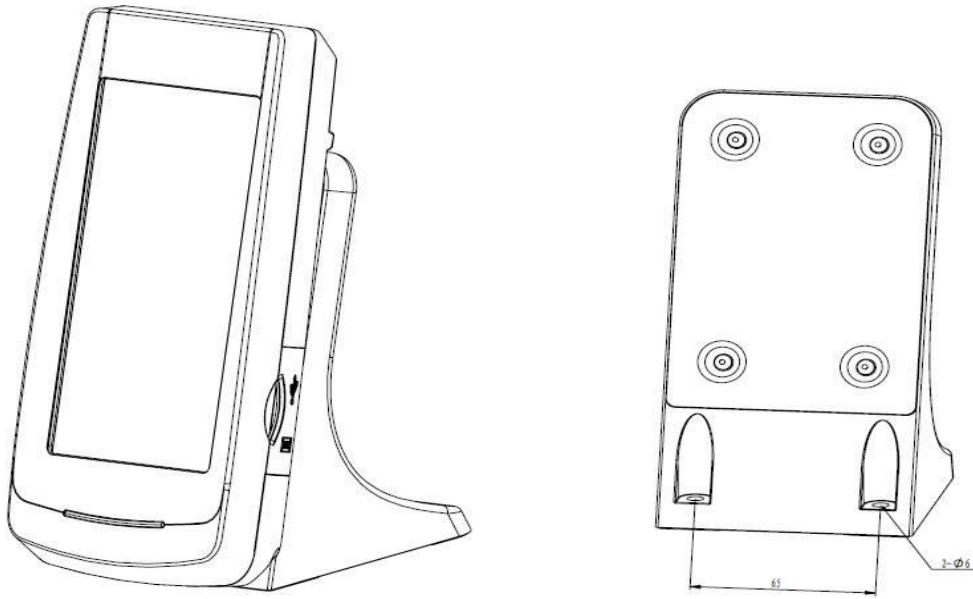
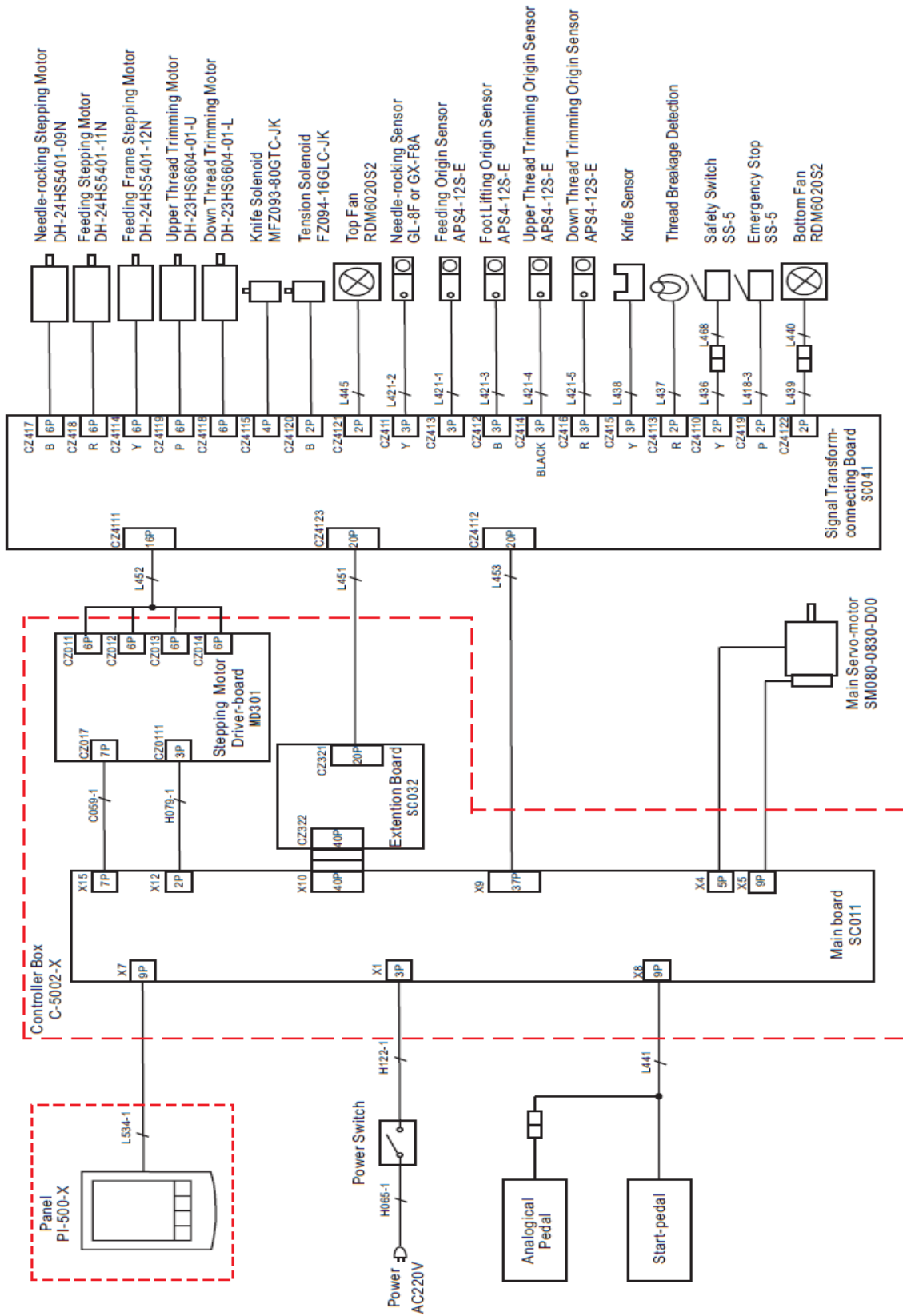

Figure 3 Installation Size of Operation Panel

# 11. 4 System Diagram

## 1、SC500-2E/X



2、MASC500-2E/X

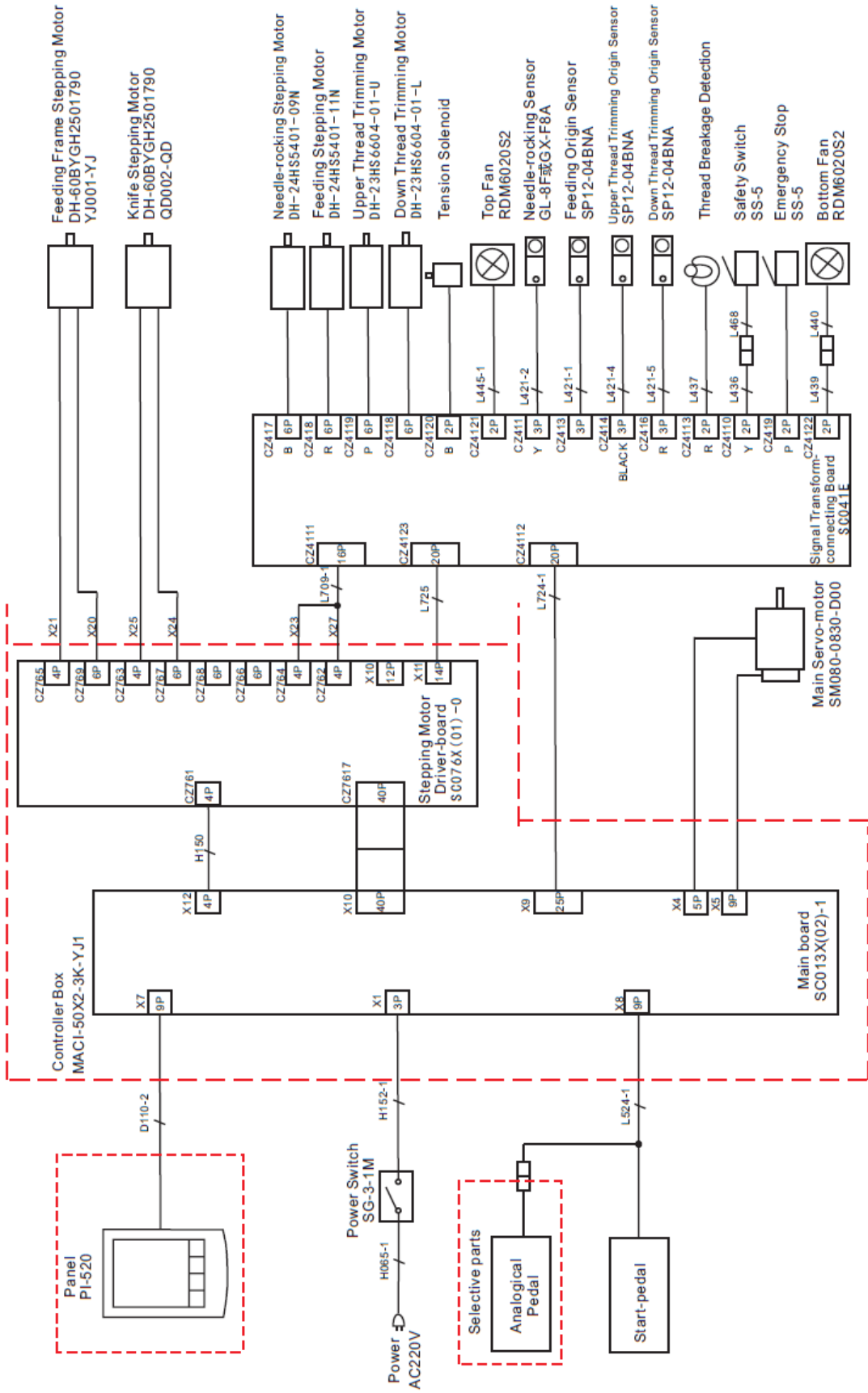

3、MASC500A-2E/X

